



**THE DATASHEET OF  
LT6654AHS6-5#TRMPBF**



Precision Wide Supply High Output Drive Low Noise Reference

**FEATURES**

- **Low Drift:**
  - **A-Grade: 10ppm/°C Max**
  - **B-Grade: 20ppm/°C Max**
- **High Accuracy:**
  - **A-Grade: ±0.05% Max**
  - **B-Grade: ±0.10% Max**
- **Low Noise: 1.6ppm<sub>p-p</sub> (0.1Hz to 10Hz)**
- **Wide Supply Range to 36V**
- **Low Thermal Hysteresis: LS8 15ppm (–40°C to 125°C)**
- **Long Term Drift: (LS8) 15ppm/√kHr**
- **Line Regulation (Up to 36V): 5ppm/V Max**
- **Low Dropout Voltage: 100mV Max**
- **Sinks and Sources ±10mA**
- **Load Regulation at 10mA: 8ppm/mA Max**
- **Fully Specified from –55°C to 125°C**
- **Available Output Voltage Options: 1.25V, 2.048V, 2.5V, 3V, 3.3V, 4.096V, 5V**
- **Low Profile (1mm) ThinSOT™ Package and 5mm × 5mm Surface Mount Hermetic Package**
- **AEC-Q100 Qualified for Automotive Applications**

**APPLICATIONS**

- Automotive Control and Monitoring
- High Temperature Industrial
- High Resolution Data Acquisition Systems
- Instrumentation and Process Control
- Precision Regulators
- Medical Equipment

**DESCRIPTION**

The **LT®6654** is a family of small precision voltage references that offers high accuracy, low noise, low drift, low dropout and low power. The LT6654 operates from voltages up to 36V and is fully specified from –55°C to 125°C. A buffered output ensures ±10mA of output drive with low output impedance and precise load regulation. These features, in combination, make the LT6654 ideal for portable equipment, industrial sensing and control, and automotive applications.

The LT6654 was designed with advanced manufacturing techniques and curvature compensation to provide 10ppm/°C temperature drift and 0.05% initial accuracy. Low thermal hysteresis ensures high accuracy and 1.6ppm<sub>p-p</sub> noise minimizes measurement uncertainty. Since the LT6654 can also sink current, it can operate as a low power negative voltage reference with the same precision as a positive reference.

The LT6654 references are offered in 6-lead SOT-23 package and an 8-lead LS8 package. The LS8 is a 5mm × 5mm surface mount hermetic package that provides outstanding stability.

All registered trademarks and trademarks are the property of their respective owners.

**TYPICAL APPLICATION**

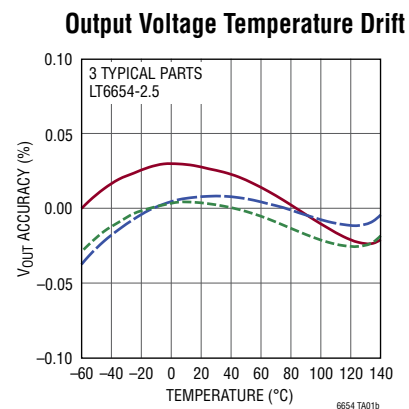
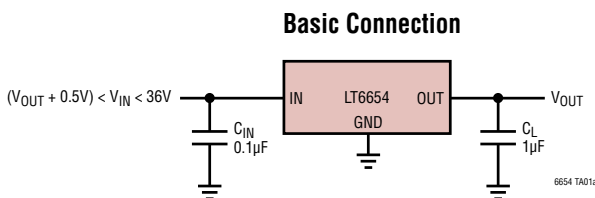

# LT6654

## ABSOLUTE MAXIMUM RATINGS (Note 1)

|                                     |                          |   |                |
|-------------------------------------|--------------------------|---|----------------|
| Input Voltage $V_{IN}$ to GND ..... | -0.3V to 38V             | Operating Temperature Range .....       | -55°C to 125°C |
| Output Voltage $V_{OUT}$ .....      | -0.3V to $V_{IN} + 0.3V$ | Storage Temperature Range (Note 2)..... | -65°C to 150°C |
| Output Short-Circuit Duration ..... | Indefinite               | Lead Temperature (Soldering, 10 sec.)   |                |
| Specified Temperature Range         |                          | (Note 9).....                           | 300°C          |
| I-Grade.....                        | -40°C to 85°C            |   |                |
| H-Grade .....                       | -40°C to 125°C           |   |                |
| MP-Grade .....                      | -55°C to 125°C           |   |                |

## PIN CONFIGURATION

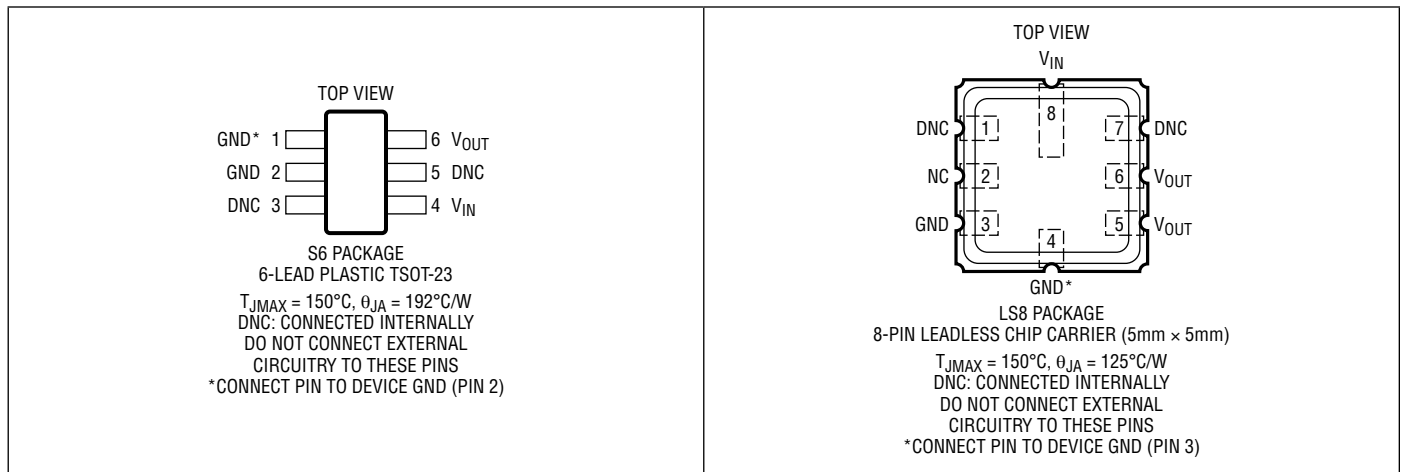

## ORDER INFORMATION

### Lead Free Finish

| TAPE AND REEL (MINI)     | TAPE AND REEL           | PART MARKING* | PACKAGE DESCRIPTION    | SPECIFIED TEMPERATURE RANGE |
|--------------------------|-------------------------|---------------|------------------------|-----------------------------|
| LT6654AIS6-1.25#TRMPBF   | LT6654AIS6-1.25#TRPBF   | LTFVD         | 6-Lead Plastic TSOT-23 | -40°C to 85°C               |
| LT6654BIS6-1.25#TRMPBF   | LT6654BIS6-1.25#TRPBF   | LTFVD         | 6-Lead Plastic TSOT-23 | -40°C to 85°C               |
| LT6654AHS6-1.25#TRMPBF   | LT6654AHS6-1.25#TRPBF   | LTFVD         | 6-Lead Plastic TSOT-23 | -40°C to 125°C              |
| LT6654BHS6-1.25#TRMPBF   | LT6654BHS6-1.25#TRPBF   | LTFVD         | 6-Lead Plastic TSOT-23 | -40°C to 125°C              |
| LT6654AMPS6-1.25#TRMPBF  | LT6654AMPS6-1.25#TRPBF  | LTFVD         | 6-Lead Plastic TSOT-23 | -55°C to 125°C              |
| LT6654BMPS6-1.25#TRMPBF  | LT6654BMPS6-1.25#TRPBF  | LTFVD         | 6-Lead Plastic TSOT-23 | -55°C to 125°C              |
| LT6654AIS6-2.048#TRMPBF  | LT6654AIS6-2.048#TRPBF  | LTFVF         | 6-Lead Plastic TSOT-23 | -40°C to 85°C               |
| LT6654BIS6-2.048#TRMPBF  | LT6654BIS6-2.048#TRPBF  | LTFVF         | 6-Lead Plastic TSOT-23 | -40°C to 85°C               |
| LT6654AHS6-2.048#TRMPBF  | LT6654AHS6-2.048#TRPBF  | LTFVF         | 6-Lead Plastic TSOT-23 | -40°C to 125°C              |
| LT6654BHS6-2.048#TRMPBF  | LT6654BHS6-2.048#TRPBF  | LTFVF         | 6-Lead Plastic TSOT-23 | -40°C to 125°C              |
| LT6654AMPS6-2.048#TRMPBF | LT6654AMPS6-2.048#TRPBF | LTFVF         | 6-Lead Plastic TSOT-23 | -55°C to 125°C              |
| LT6654BMPS6-2.048#TRMPBF | LT6654BMPS6-2.048#TRPBF | LTFVF         | 6-Lead Plastic TSOT-23 | -55°C to 125°C              |

## ORDER INFORMATION

### Lead Free Finish

| TAPE AND REEL (MINI)     | TAPE AND REEL           | PART MARKING*                  | PACKAGE DESCRIPTION                | SPECIFIED TEMPERATURE RANGE |
|--------------------------|-------------------------|--------------------------------|------------------------------------|-----------------------------|
| LT6654AIS6-2.5#TRMPBF    | LT6654AIS6-2.5#TRPBF    | LTFJY                          | 6-Lead Plastic TSOT-23             | -40°C to 85°C               |
| LT6654BIS6-2.5#TRMPBF    | LT6654BIS6-2.5#TRPBF    | LTFJY                          | 6-Lead Plastic TSOT-23             | -40°C to 85°C               |
| LT6654AHS6-2.5#TRMPBF    | LT6654AHS6-2.5#TRPBF    | LTFJY                          | 6-Lead Plastic TSOT-23             | -40°C to 125°C              |
| LT6654BHS6-2.5#TRMPBF    | LT6654BHS6-2.5#TRPBF    | LTFJY                          | 6-Lead Plastic TSOT-23             | -40°C to 125°C              |
| LT6654AMPS6-2.5#TRMPBF   | LT6654AMPS6-2.5#TRPBF   | LTFJY                          | 6-Lead Plastic TSOT-23             | -55°C to 125°C              |
| LT6654BMPS6-2.5#TRMPBF   | LT6654BMPS6-2.5#TRPBF   | LTFJY                          | 6-Lead Plastic TSOT-23             | -55°C to 125°C              |
| LT6654AIS6-3#TRMPBF      | LT6654AIS6-3#TRPBF      | LTFVG                          | 6-Lead Plastic TSOT-23             | -40°C to 85°C               |
| LT6654BIS6-3#TRMPBF      | LT6654BIS6-3#TRPBF      | LTFVG                          | 6-Lead Plastic TSOT-23             | -40°C to 85°C               |
| LT6654AHS6-3#TRMPBF      | LT6654AHS6-3#TRPBF      | LTFVG                          | 6-Lead Plastic TSOT-23             | -40°C to 125°C              |
| LT6654BHS6-3#TRMPBF      | LT6654BHS6-3#TRPBF      | LTFVG                          | 6-Lead Plastic TSOT-23             | -40°C to 125°C              |
| LT6654AMPS6-3#TRMPBF     | LT6654AMPS6-3#TRPBF     | LTFVG                          | 6-Lead Plastic TSOT-23             | -55°C to 125°C              |
| LT6654BMPS6-3#TRMPBF     | LT6654BMPS6-3#TRPBF     | LTFVG                          | 6-Lead Plastic TSOT-23             | -55°C to 125°C              |
| LT6654AIS6-3.3#TRMPBF    | LT6654AIS6-3.3#TRPBF    | LTFVH                          | 6-Lead Plastic TSOT-23             | -40°C to 85°C               |
| LT6654BIS6-3.3#TRMPBF    | LT6654BIS6-3.3#TRPBF    | LTFVH                          | 6-Lead Plastic TSOT-23             | -40°C to 85°C               |
| LT6654AHS6-3.3#TRMPBF    | LT6654AHS6-3.3#TRPBF    | LTFVH                          | 6-Lead Plastic TSOT-23             | -40°C to 125°C              |
| LT6654BHS6-3.3#TRMPBF    | LT6654BHS6-3.3#TRPBF    | LTFVH                          | 6-Lead Plastic TSOT-23             | -40°C to 125°C              |
| LT6654AMPS6-3.3#TRMPBF   | LT6654AMPS6-3.3#TRPBF   | LTFVH                          | 6-Lead Plastic TSOT-23             | -55°C to 125°C              |
| LT6654BMPS6-3.3#TRMPBF   | LT6654BMPS6-3.3#TRPBF   | LTFVH                          | 6-Lead Plastic TSOT-23             | -55°C to 125°C              |
| LT6654AIS6-4.096#TRMPBF  | LT6654AIS6-4.096#TRPBF  | LTFVJ                          | 6-Lead Plastic TSOT-23             | -40°C to 85°C               |
| LT6654BIS6-4.096#TRMPBF  | LT6654BIS6-4.096#TRPBF  | LTFVJ                          | 6-Lead Plastic TSOT-23             | -40°C to 85°C               |
| LT6654AHS6-4.096#TRMPBF  | LT6654AHS6-4.096#TRPBF  | LTFVJ                          | 6-Lead Plastic TSOT-23             | -40°C to 125°C              |
| LT6654BHS6-4.096#TRMPBF  | LT6654BHS6-4.096#TRPBF  | LTFVJ                          | 6-Lead Plastic TSOT-23             | -40°C to 125°C              |
| LT6654AMPS6-4.096#TRMPBF | LT6654AMPS6-4.096#TRPBF | LTFVJ                          | 6-Lead Plastic TSOT-23             | -55°C to 125°C              |
| LT6654BMPS6-4.096#TRMPBF | LT6654BMPS6-4.096#TRPBF | LTFVJ                          | 6-Lead Plastic TSOT-23             | -55°C to 125°C              |
| LT6654AIS6-5#TRMPBF      | LT6654AIS6-5#TRPBF      | LTFVK                          | 6-Lead Plastic TSOT-23             | -40°C to 85°C               |
| LT6654BIS6-5#TRMPBF      | LT6654BIS6-5#TRPBF      | LTFVK                          | 6-Lead Plastic TSOT-23             | -40°C to 85°C               |
| LT6654AHS6-5#TRMPBF      | LT6654AHS6-5#TRPBF      | LTFVK                          | 6-Lead Plastic TSOT-23             | -40°C to 125°C              |
| LT6654BHS6-5#TRMPBF      | LT6654BHS6-5#TRPBF      | LTFVK                          | 6-Lead Plastic TSOT-23             | -40°C to 125°C              |
| LT6654AMPS6-5#TRMPBF     | LT6654AMPS6-5#TRPBF     | LTFVK                          | 6-Lead Plastic TSOT-23             | -55°C to 125°C              |
| LT6654BMPS6-5#TRMPBF     | LT6654BMPS6-5#TRPBF     | LTFVK                          | 6-Lead Plastic TSOT-23             | -55°C to 125°C              |
| <b>LEAD FREE FINISH†</b> | <b>PART MARKING*</b>    | <b>PACKAGE DESCRIPTION</b>     | <b>SPECIFIED TEMPERATURE RANGE</b> |                             |
| LT6654AHL8-2.048#PBF     | 542048                  | 8-Lead Ceramic LCC (5mm × 5mm) | -40°C to 125°C                     |                             |
| LT6654BHL8-2.048#PBF     | 542048                  | 8-Lead Ceramic LCC (5mm × 5mm) | -40°C to 125°C                     |                             |
| LT6654AHL8-2.5#PBF       | 665425                  | 8-Lead Ceramic LCC (5mm × 5mm) | -40°C to 125°C                     |                             |
| LT6654BHL8-2.5#PBF       | 665425                  | 8-Lead Ceramic LCC (5mm × 5mm) | -40°C to 125°C                     |                             |
| LT6654AHL8-4.096#PBF     | 544096                  | 8-Lead Ceramic LCC (5mm × 5mm) | -40°C to 125°C                     |                             |
| LT6654BHL8-4.096#PBF     | 544096                  | 8-Lead Ceramic LCC (5mm × 5mm) | -40°C to 125°C                     |                             |
| LT6654AHL8-5#PBF         | 66545                   | 8-Lead Ceramic LCC (5mm × 5mm) | -40°C to 125°C                     |                             |
| LT6654BHL8-5#PBF         | 66545                   | 8-Lead Ceramic LCC (5mm × 5mm) | -40°C to 125°C                     |                             |

## ORDER INFORMATION

### AUTOMOTIVE PRODUCTS\*\*

| TAPE AND REEL (MINI)     | TAPE AND REEL           | PART MARKING* | PACKAGE DESCRIPTION    | SPECIFIED TEMPERATURE RANGE |
|--------------------------|-------------------------|---------------|------------------------|-----------------------------|
| LT6654AHS6-1.25#WTRMPBF  | LT6654AHS6-1.25#WTRPBF  | LTFVD         | 6-Lead Plastic TSOT-23 | -40°C to 125°C              |
| LT6654BHS6-1.25#WTRMPBF  | LT6654BHS6-1.25#WTRPBF  | LTFVD         | 6-Lead Plastic TSOT-23 | -40°C to 125°C              |
| LT6654AHS6-2.048#WTRMPBF | LT6654AHS6-2.048#WTRPBF | LTFVF         | 6-Lead Plastic TSOT-23 | -40°C to 125°C              |
| LT6654BHS6-2.048#WTRMPBF | LT6654BHS6-2.048#WTRPBF | LTFVF         | 6-Lead Plastic TSOT-23 | -40°C to 125°C              |
| LT6654AHS6-2.5#WTRMPBF   | LT6654AHS6-2.5#WTRPBF   | LTFJY         | 6-Lead Plastic TSOT-23 | -40°C to 125°C              |
| LT6654BHS6-2.5#WTRMPBF   | LT6654BHS6-2.5#WTRPBF   | LTFJY         | 6-Lead Plastic TSOT-23 | -40°C to 125°C              |
| LT6654AHS6-3#WTRMPBF     | LT6654AHS6-3#WTRPBF     | LTFVG         | 6-Lead Plastic TSOT-23 | -40°C to 125°C              |
| LT6654BHS6-3#WTRMPBF     | LT6654BHS6-3#WTRPBF     | LTFVG         | 6-Lead Plastic TSOT-23 | -40°C to 125°C              |
| LT6654AHS6-3.3#WTRMPBF   | LT6654AHS6-3.3#WTRPBF   | LTFVH         | 6-Lead Plastic TSOT-23 | -40°C to 125°C              |
| LT6654BHS6-3.3#WTRMPBF   | LT6654BHS6-3.3#WTRPBF   | LTFVH         | 6-Lead Plastic TSOT-23 | -40°C to 125°C              |
| LT6654AHS6-4.096#WTRMPBF | LT6654AHS6-4.096#WTRPBF | LTFVJ         | 6-Lead Plastic TSOT-23 | -40°C to 125°C              |
| LT6654BHS6-4.096#WTRMPBF | LT6654BHS6-4.096#WTRPBF | LTFVJ         | 6-Lead Plastic TSOT-23 | -40°C to 125°C              |
| LT6654AHS6-5#WTRMPBF     | LT6654AHS6-5#WTRPBF     | LTFVK         | 6-Lead Plastic TSOT-23 | -40°C to 125°C              |
| LT6654BHS6-5#WTRMPBF     | LT6654BHS6-5#WTRPBF     | LTFVK         | 6-Lead Plastic TSOT-23 | -40°C to 125°C              |

TRM = 500 pieces. \*Temperature grades are identified by a label on the shipping container.

Contact the factory for parts specified with wider operating temperature ranges.

Contact the factory for information on lead based finish parts.

**Tape and reel specifications.** Some packages are available in 500 unit reels through designated sales channels with #TRMPBF suffix.

†This product is only offered in trays. For more information go to: <https://www.analog.com/en/design-center/packaging-quality-symbols-footprints.html>

\*\*Versions of this part are available with controlled manufacturing to support the quality and reliability requirements of automotive applications. These models are designated with a #W suffix. Only the automotive grade products shown are available for use in automotive applications. Contact your local Analog Devices account representative for specific product ordering information and to obtain the specific Automotive Reliability reports for these models.

## AVAILABLE OPTIONS

| OUTPUT VOLTAGE | INITIAL ACCURACY | TEMPERATURE COEFFICIENT | ORDER PART NUMBER** | SPECIFIED TEMPERATURE RANGE |
|----------------|------------------|-------------------------|---------------------|-----------------------------|
| 1.25V          | 0.05%            | 10ppm/°C                | LT6654AIS6-1.25     | -40°C to 85°C               |
|                | 0.1%             | 20ppm/°C                | LT6654BIS6-1.25     | -40°C to 85°C               |
|                | 0.05%            | 10ppm/°C                | LT6654AHS6-1.25     | -40°C to 125°C              |
|                | 0.1%             | 20ppm/°C                | LT6654BHS6-1.25     | -40°C to 125°C              |
|                | 0.05%            | 10ppm/°C                | LT6654AMPS6-1.25    | -55°C to 125°C              |
|                | 0.1%             | 20ppm/°C                | LT6654BMPS6-1.25    | -55°C to 125°C              |
| 2.048V         | 0.05%            | 10ppm/°C                | LT6654AIS6-2.048    | -40°C to 85°C               |
|                | 0.1%             | 20ppm/°C                | LT6654BIS6-2.048    | -40°C to 85°C               |
|                | 0.05%            | 10ppm/°C                | LT6654AHS6-2.048    | -40°C to 125°C              |
|                | 0.05%            | 10ppm/°C                | LT6654AHL8-2.048    | -40°C to 125°C              |
|                | 0.1%             | 20ppm/°C                | LT6654BHS6-2.048    | -40°C to 125°C              |
|                | 0.1%             | 20ppm/°C                | LT6654BHLS8-2.048   | -40°C to 125°C              |
|                | 0.05%            | 10ppm/°C                | LT6654AMPS6-2.048   | -55°C to 125°C              |
|                | 0.1%             | 20ppm/°C                | LT6654BMPS6-2.048   | -55°C to 125°C              |
| 2.5V           | 0.05%            | 10ppm/°C                | LT6654AIS6-2.5      | -40°C to 85°C               |
|                | 0.1%             | 20ppm/°C                | LT6654BIS6-2.5      | -40°C to 85°C               |
|                | 0.05%            | 10ppm/°C                | LT6654AHS6-2.5      | -40°C to 125°C              |
|                | 0.05%            | 10ppm/°C                | LT6654AHL8-2.5      | -40°C to 125°C              |
|                | 0.1%             | 20ppm/°C                | LT6654BHS6-2.5      | -40°C to 125°C              |
|                | 0.1%             | 20ppm/°C                | LT6654BHLS8-2.5     | -40°C to 125°C              |
|                | 0.05%            | 10ppm/°C                | LT6654AMPS6-2.5     | -55°C to 125°C              |
|                | 0.1%             | 20ppm/°C                | LT6654BMPS6-2.5     | -55°C to 125°C              |
| 3V             | 0.05%            | 10ppm/°C                | LT6654AIS6-3        | -40°C to 85°C               |
|                | 0.1%             | 20ppm/°C                | LT6654BIS6-3        | -40°C to 85°C               |
|                | 0.05%            | 10ppm/°C                | LT6654AHS6-3        | -40°C to 125°C              |
|                | 0.1%             | 20ppm/°C                | LT6654BHS6-3        | -40°C to 125°C              |
|                | 0.05%            | 10ppm/°C                | LT6654AMPS6-3       | -55°C to 125°C              |
|                | 0.1%             | 20ppm/°C                | LT6654BMPS6-3       | -55°C to 125°C              |
| 3.3V           | 0.05%            | 10ppm/°C                | LT6654AIS6-3.3      | -40°C to 85°C               |
|                | 0.1%             | 20ppm/°C                | LT6654BIS6-3.3      | -40°C to 85°C               |
|                | 0.05%            | 10ppm/°C                | LT6654AHS6-3.3      | -40°C to 125°C              |
|                | 0.1%             | 20ppm/°C                | LT6654BHS6-3.3      | -40°C to 125°C              |
|                | 0.05%            | 10ppm/°C                | LT6654AMPS6-3.3     | -55°C to 125°C              |
|                | 0.1%             | 20ppm/°C                | LT6654BMPS6-3.3     | -55°C to 125°C              |
| 4.096V         | 0.05%            | 10ppm/°C                | LT6654AIS6-4.096    | -40°C to 85°C               |
|                | 0.1%             | 20ppm/°C                | LT6654BIS6-4.096    | -40°C to 85°C               |
|                | 0.05%            | 10ppm/°C                | LT6654AHS6-4.096    | -40°C to 125°C              |
|                | 0.05%            | 10ppm/°C                | LT6654AHL8-4.096    | -40°C to 125°C              |
|                | 0.1%             | 20ppm/°C                | LT6654BHS6-4.096    | -40°C to 125°C              |
|                | 0.1%             | 20ppm/°C                | LT6654BHLS8-4.096   | -40°C to 125°C              |
|                | 0.05%            | 10ppm/°C                | LT6654AMPS6-4.096   | -55°C to 125°C              |
|                | 0.1%             | 20ppm/°C                | LT6654BMPS6-4.096   | -55°C to 125°C              |
| 5V             | 0.05%            | 10ppm/°C                | LT6654AIS6-5        | -40°C to 85°C               |
|                | 0.1%             | 20ppm/°C                | LT6654BIS6-5        | -40°C to 85°C               |
|                | 0.05%            | 10ppm/°C                | LT6654AHS6-5        | -40°C to 125°C              |
|                | 0.05%            | 10ppm/°C                | LT6654AHL8-5        | -40°C to 125°C              |
|                | 0.1%             | 20ppm/°C                | LT6654BHS6-5        | -40°C to 125°C              |
|                | 0.1%             | 20ppm/°C                | LT6654BHLS8-5       | -40°C to 125°C              |
|                | 0.05%            | 10ppm/°C                | LT6654AMPS6-5       | -55°C to 125°C              |
|                | 0.1%             | 20ppm/°C                | LT6654BMPS6-5       | -55°C to 125°C              |

\*\* See the Order Information section for complete part number listing.

## ELECTRICAL CHARACTERISTICS

The ● denotes the specifications which apply over the full operating temperature range, otherwise specifications are at  $T_A = 25^\circ\text{C}$ ,  $C_L = 1\mu\text{F}$  and  $V_{IN} = V_{OUT} + 0.5\text{V}$ , unless otherwise noted. For LT6654-1.25,  $V_{IN} = 2.4\text{V}$ , unless otherwise noted.

| PARAMETER   | CONDITIONS   |  | MIN            | TYP        | MAX                 | UNITS                                    |                                      |
|---|--|--|----------------|------------|---------------------|--|--------------------------------------|
| Output Voltage Accuracy   | LT6654A  |  | -0.05          |            | 0.05                | %  |                                      |
|   | LT6654B  |  | -0.10          |            | 0.10                | %  |                                      |
|   | LT6654AI   | ●  | -0.175         |            | 0.175               | %  |                                      |
|   | LT6654BI   | ●  | -0.35          |            | 0.35                | %  |                                      |
|   | LT6654AH   | ●  | -0.215         |            | 0.215               | %  |                                      |
|   | LT6654BH   | ●  | -0.43          |            | 0.43                | %  |                                      |
|   | LT6654AMP<br>LT6654BMP   | ●<br>●   | -0.23<br>-0.46 |            | 0.23<br>0.46        | %  |                                      |
| Output Voltage Temperature Coefficient (Note 3)                     | LT6654A  | ●  |                | 3          | 10                  | ppm/°C                                   |                                      |
|   | LT6654B  | ●  |                | 10         | 20                  | ppm/°C                                   |                                      |
| Line Regulation   | $V_{OUT} + 0.5\text{V} \leq V_{IN} \leq 36\text{V}$<br>LT6654-2.048, LT6654-2.5, LT6654-3,<br>LT6654-3.3, LT6654-4.096, LT6654-5                     | ●  |                | 1.2        | 5<br>10             | ppm/V<br>ppm/V                           |                                      |
|   | $2.4\text{V} \leq V_{IN} \leq 36\text{V}$<br>LT6654-1.25   | ●  |                | 1.2        | 5<br>10             | ppm/V<br>ppm/V                           |                                      |
| Load Regulation (Note 4)  | $I_{OUT(SOURCE)} = 10\text{mA}$<br>LT6654-2.048, LT6654-2.5, LT6654-3,<br>LT6654-3.3, LT6654-4.096, LT6654-5<br>LT6654-1.25                          | ●<br>●<br>●  |                | 3<br>6     | 8<br>15<br>15<br>20 | ppm/mA<br>ppm/mA<br>ppm/mA<br>ppm/mA     |                                      |
|   | LT6654LS8  | ●  |                | 10         | 30<br>45            | ppm/mA<br>ppm/mA                         |                                      |
|   | $I_{OUT(SINK)} = 10\text{mA}$<br>LT6654-2.048, LT6654-2.5, LT6654-3,<br>LT6654-3.3, LT6654-4.096, LT6654-5<br>LT6654-1.25                            | ●<br>●   |                |            | 9<br>15             | 20<br>30<br>30<br>30                     | ppm/mA<br>ppm/mA<br>ppm/mA<br>ppm/mA |
|   |  | LT6654LS8  | ●              |            | 30                  | 60<br>90                                 | ppm/mA<br>ppm/mA                     |
| Dropout Voltage (Note 5)  | $V_{IN} - V_{OUT}$ , $\Delta V_{OUT} = 0.1\%$<br>$I_{OUT} = 0\text{mA}$<br>LT6654-2.048, LT6654-2.5, LT6654-3,<br>LT6654-3.3, LT6654-4.096, LT6654-5 | ●<br>●   |                | 55         | 100<br>120          | mV<br>mV                                 |                                      |
|   | $I_{OUT(SOURCE)} = 10\text{mA}$  | ●  |                |            | 450                 | mV                                       |                                      |
|   | $I_{OUT(SINK)} = -10\text{mA}$   | ●  |                |            | 50                  | mV                                       |                                      |
|   | Minimum Input Voltage  | LT6654-1.25, $\Delta V_{OUT} = 0.1\%$ , $I_{OUT} = 0\text{mA}$ | ●              |            | 1.5                 | 1.6<br>1.8                               | V<br>V                               |
| LT6654-1.25, $\Delta V_{OUT} = 0.1\%$ , $I_{OUT} = \pm 10\text{mA}$ |  | ●  |                |            | 2.4                 | V  |                                      |
| Supply Current  | No Load  | ●  |                | 350        | 600                 | $\mu\text{A}$<br>$\mu\text{A}$           |                                      |
|   |  |  |                |            |                     |  |                                      |
| Output Short-Circuit Current  | Short $V_{OUT}$ to GND   |  |                | 40         |                     | mA                                       |                                      |
|   | Short $V_{OUT}$ to $V_{IN}$  |  |                | 30         |                     | mA                                       |                                      |
| Output Voltage Noise (Note 6)                                       | $0.1\text{Hz} \leq f \leq 10\text{Hz}$<br>LT6654-1.25  |  |                | 0.8        |                     | ppm <sub>p-p</sub>                       |                                      |
|   | LT6654-2.048   |  |                | 1.0        |                     | ppm <sub>p-p</sub>                       |                                      |
|   | LT6654-2.5   |  |                | 1.5        |                     | ppm <sub>p-p</sub>                       |                                      |
|   | LT6654-3   |  |                | 1.6        |                     | ppm <sub>p-p</sub>                       |                                      |
|   | LT6654-3.3   |  |                | 1.7        |                     | ppm <sub>p-p</sub>                       |                                      |
|   | LT6654-4.096   |  |                | 2.0        |                     | ppm <sub>p-p</sub>                       |                                      |
|   | LT6654-5<br>$10\text{Hz} \leq f \leq 1\text{kHz}$  |  |                | 2.2<br>2.0 |                     | ppm <sub>p-p</sub><br>ppm <sub>RMS</sub> |                                      |

**ELECTRICAL CHARACTERISTICS** The ● denotes the specifications which apply over the full operating temperature range, otherwise specifications are at  $T_A = 25^\circ\text{C}$ ,  $C_L = 1\mu\text{F}$  and  $V_{IN} = V_{OUT} + 0.5\text{V}$ , unless otherwise noted. For LT6654-1.25,  $V_{IN} = 2.4\text{V}$ , unless otherwise noted.

| PARAMETER                                  | CONDITIONS  | MIN | TYP | MAX | UNITS                          |
|--|---|-----|-----|-----|--------------------------------|
| Turn-On Time                               | 0.1% Settling, $C_{LOAD} = 1\mu\text{F}$  |     | 150 |     | $\mu\text{s}$                  |
| Long-Term Drift of Output Voltage (Note 7) | LT6654S6  |     | 60  |     | $\text{ppm}/\sqrt{\text{kHr}}$ |
|  | LT6654LS8   |     | 15  |     | $\text{ppm}/\sqrt{\text{kHr}}$ |
| Hysteresis (Note 8)                        | S6<br>$\Delta T = 0^\circ\text{C}$ to $70^\circ\text{C}$<br>$\Delta T = -40^\circ\text{C}$ to $85^\circ\text{C}$<br>$\Delta T = -40^\circ\text{C}$ to $125^\circ\text{C}$<br>$\Delta T = -55^\circ\text{C}$ to $125^\circ\text{C}$  |     | 15  |     | ppm                            |
|  |   |     | 30  |     | ppm                            |
|  |   |     | 40  |     | ppm                            |
|  |   |     | 50  |     | ppm                            |
|  | LS8<br>$\Delta T = 0^\circ\text{C}$ to $70^\circ\text{C}$<br>$\Delta T = -40^\circ\text{C}$ to $85^\circ\text{C}$<br>$\Delta T = -40^\circ\text{C}$ to $125^\circ\text{C}$<br>$\Delta T = -55^\circ\text{C}$ to $125^\circ\text{C}$ |     | 3   |     | ppm                            |
|  |   |     | 11  |     | ppm                            |
|  |   |     | 15  |     | ppm                            |
|  |   |     | 20  |     | ppm                            |

**Note 1:** Stresses beyond those listed under Absolute Maximum Ratings may cause permanent damage to the device. Exposure to any Absolute Maximum Rating condition for extended periods may affect device reliability and lifetime.

**Note 2:** If the parts are stored outside of the specified temperature range, the output may shift due to hysteresis.

**Note 3:** Temperature coefficient is measured by dividing the maximum change in output voltage by the specified temperature range.

**Note 4:** Load regulation is measured on a pulse basis from no load to the specified load current. Output changes due to die temperature change must be taken into account separately.

**Note 5:** Excludes load regulation errors.

**Note 6:** Peak-to-peak noise is measured with a 1-pole highpass filter at 0.1Hz and 2-pole lowpass filter at 10Hz. The unit is enclosed in a still-air environment to eliminate thermocouple effects on the leads. The test time is 10 seconds. RMS noise is measured on a spectrum analyzer in a shielded environment where the intrinsic noise of the instrument is removed to determine the actual noise of the device.

**Note 7:** Long-term stability typically has a logarithmic characteristic and therefore, changes after 1000 hours tend to be much smaller than before that time. Total drift in the second thousand hours is normally less than one third that of the first thousand hours with a continuing trend toward reduced drift with time. Long-term stability will also be affected by differential stresses between the IC and the board material created during board assembly.

**Note 8:** Hysteresis in output voltage is created by package stress that differs depending on whether the IC was previously at a higher or lower temperature. Output voltage is always measured at  $25^\circ\text{C}$ , but the IC is cycled to the hot or cold temperature limit before successive measurements. Hysteresis measures the maximum output change for the averages of three hot or cold temperature cycles. For instruments that are stored at well controlled temperatures (within 20 or 30 degrees of operational temperature), it is usually not a dominant error source. Typical hysteresis is the worst-case of  $25^\circ\text{C}$  to cold to  $25^\circ\text{C}$  or  $25^\circ\text{C}$  to hot to  $25^\circ\text{C}$ , preconditioned by one thermal cycle.

**Note 9:** The stated temperature is typical for soldering of the leads during manual rework. For detailed IR reflow recommendations, refer to the Applications Information section.

## TYPICAL PERFORMANCE CHARACTERISTICS

The characteristic curves are similar across the LT6654 family. Curves from the LT6654-1.25, LT6654-2.5 and the LT6654-5 represent the full range of typical performance of all voltage options. Characteristic curves for other output voltages fall between these curves and can be estimated based on their output.

**1.25V Output Voltage Temperature Drift**

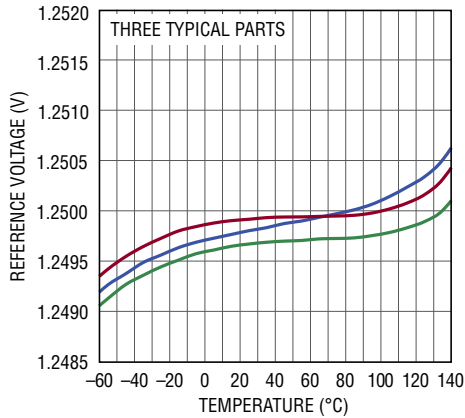

**1.25V Turn-On Characteristics**

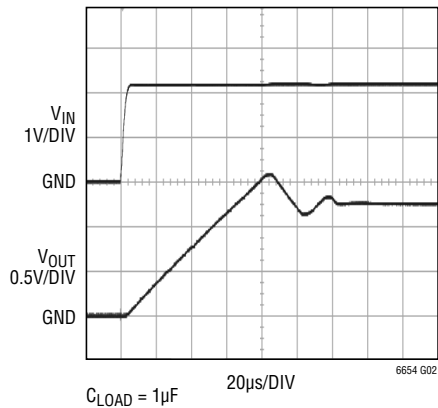

**1.25V Output Impedance vs Frequency**

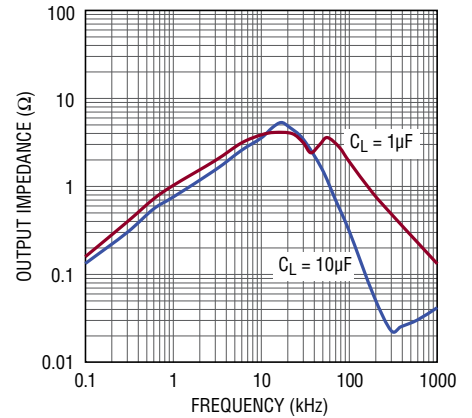

**1.25V Load Regulation (Sourcing)**

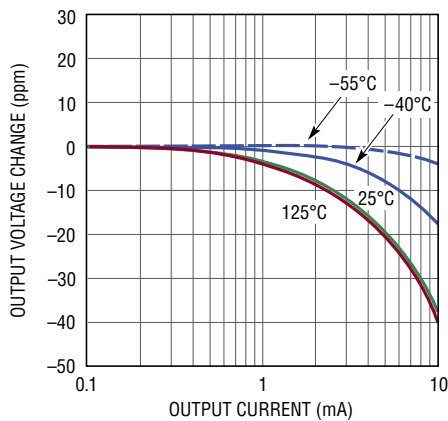

**1.25V Load Regulation (Sinking)**

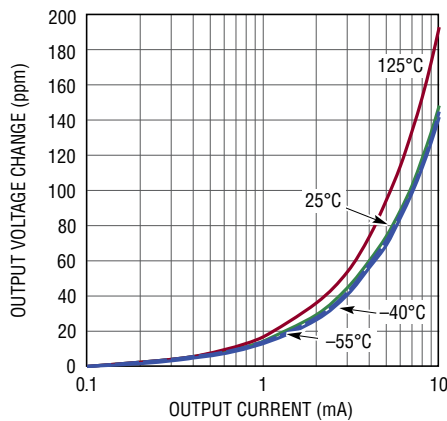

**1.25V Output Noise 0.1Hz to 10Hz**

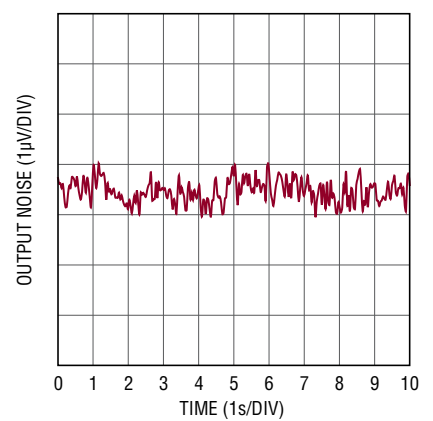

**1.25V Minimum Input Voltage (Sourcing)**

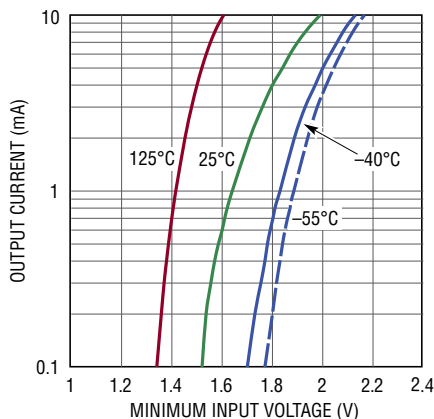

**1.25V Minimum Input Voltage (Sinking)**

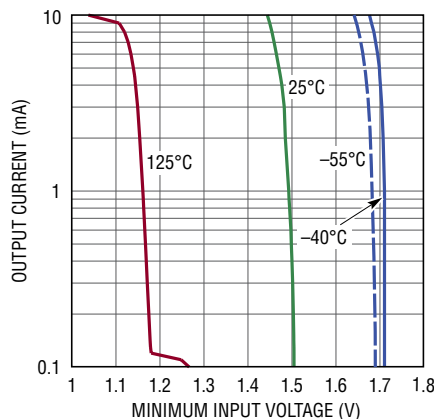

**1.2V Output Voltage Noise Spectrum**

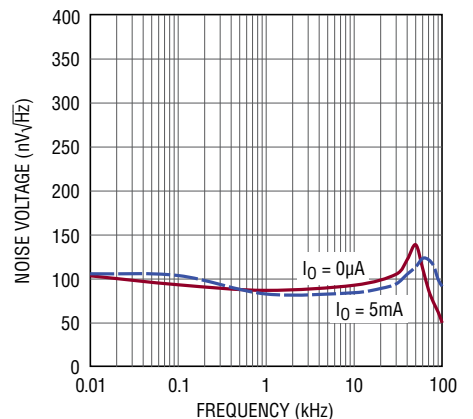

**TYPICAL PERFORMANCE CHARACTERISTICS** The characteristic curves are similar across the LT6654 family. Curves from the LT6654-1.25, LT6654-2.5 and the LT6654-5 represent the full range of typical performance of all voltage options. Characteristic curves for other output voltages fall between these curves and can be estimated based on their output.

**2.5V Output Voltage Temperature Drift**

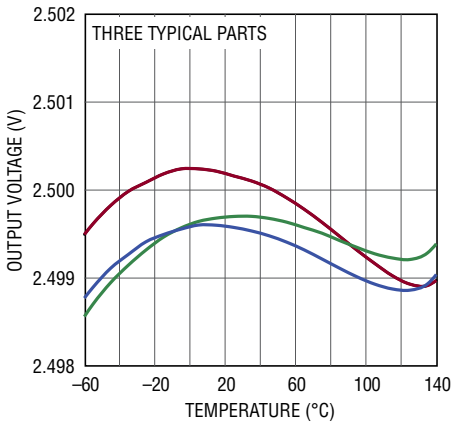

**2.5V Supply Current vs Input Voltage**

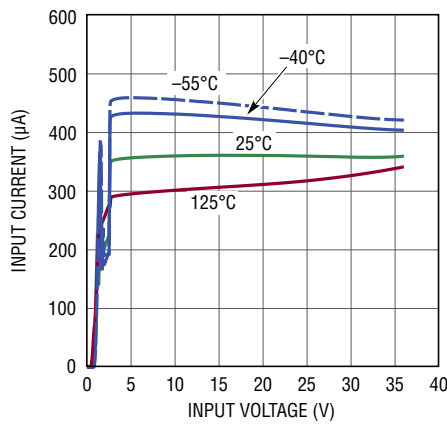

**2.5V Line Regulation**

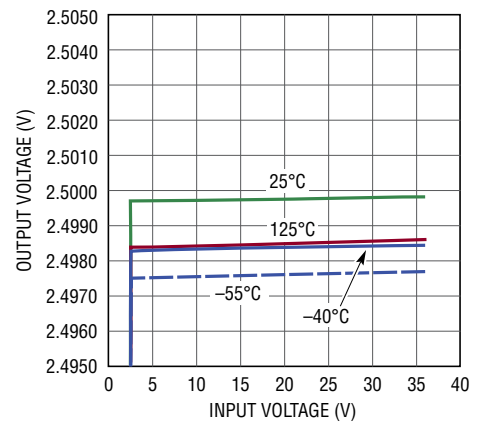

**2.5V Load Regulation (Sourcing)**

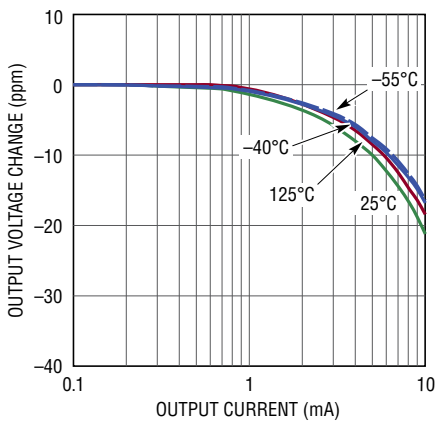

**2.5V Load Regulation (Sinking)**

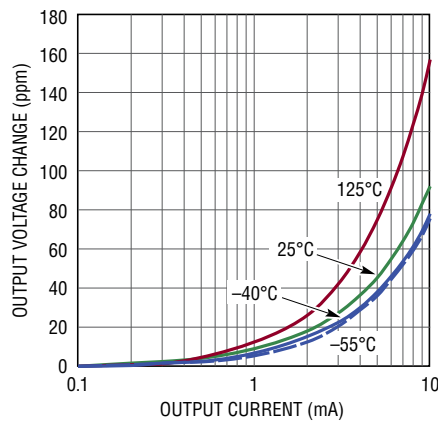

**2.5V Output Noise 0.1Hz to 10Hz**

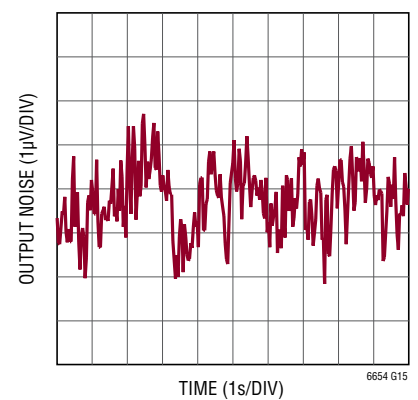

**2.5V Minimum  $V_{IN}$  to  $V_{OUT}$  Differential (Sourcing)**

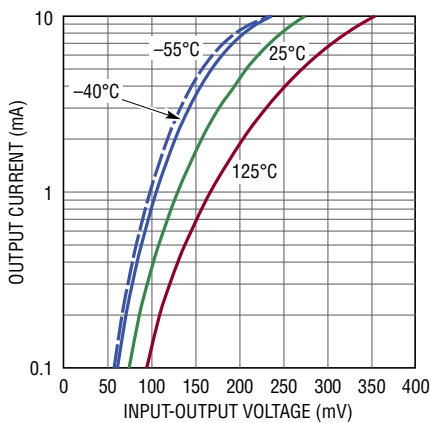

**2.5V Minimum  $V_{IN}$  to  $V_{OUT}$  Differential (Sinking)**

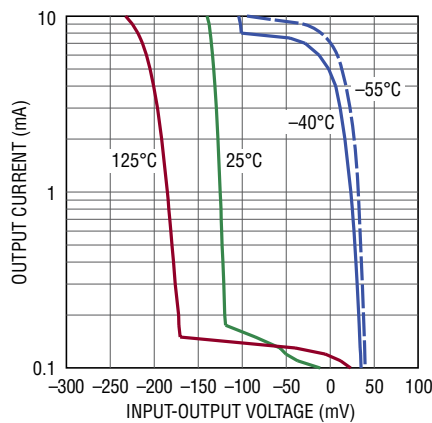

**2.5V Output Voltage Noise Spectrum**

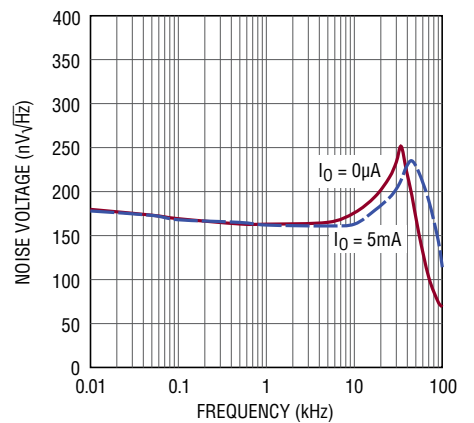

## TYPICAL PERFORMANCE CHARACTERISTICS

The characteristic curves are similar across the LT6654 family. Curves from the LT6654-1.25, LT6654-2.5 and the LT6654-5 represent the full range of typical performance of all voltage options. Characteristic curves for other output voltages fall between these curves and can be estimated based on their output.

**2.5V Integrated Noise  
10Hz to 10kHz**

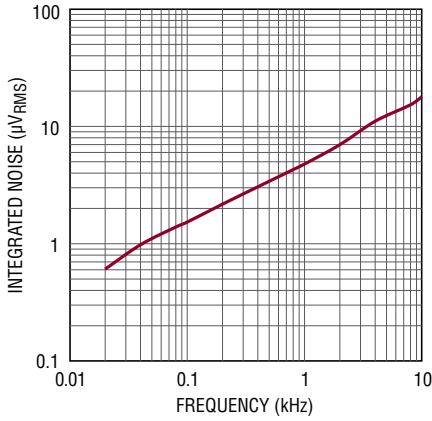

6654 G19

**2.5V Power Supply Rejection  
Ratio vs Frequency**

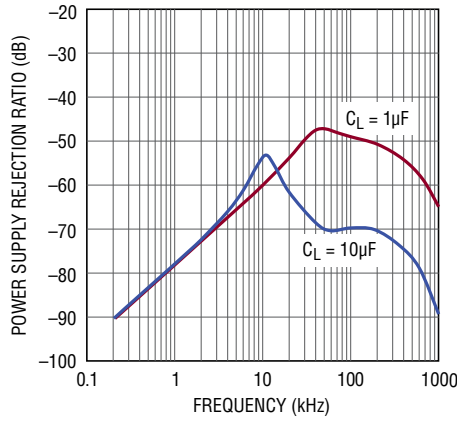

6654 G20

**2.5V Output Impedance  
vs Frequency**

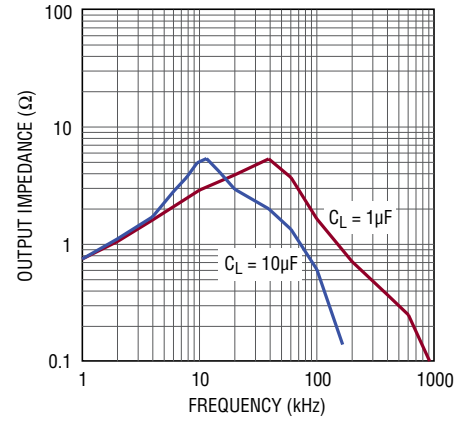

6654 G21

**2.5V Turn-On Characteristics**

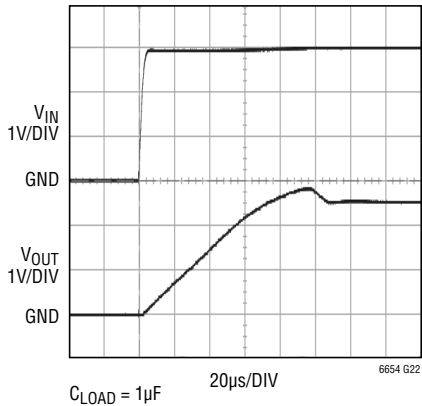

6654 G22

**2.5V Line Transient Response**

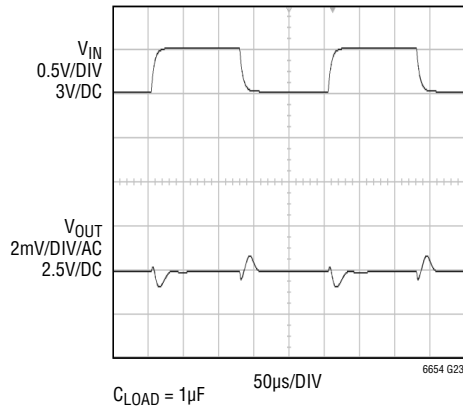

6654 G23

**2.5V Load Transient Response  
(Sourcing)**

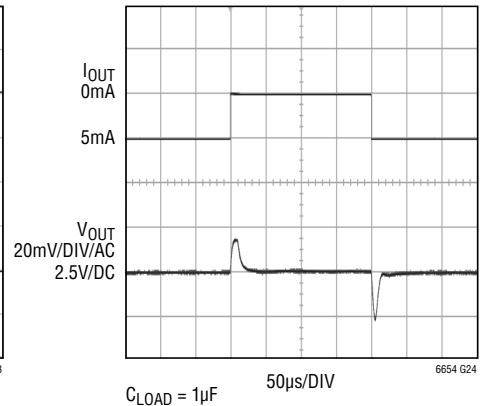

6654 G24

**2.5V Hysteresis Plot for -40°C  
and 125°C (TSOT-23)**

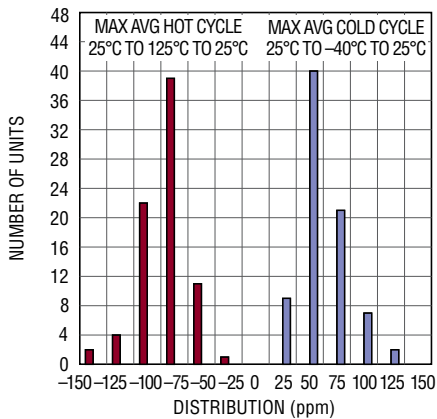

6654 G25

**2.5V Long Term Drift (TSOT-23)**

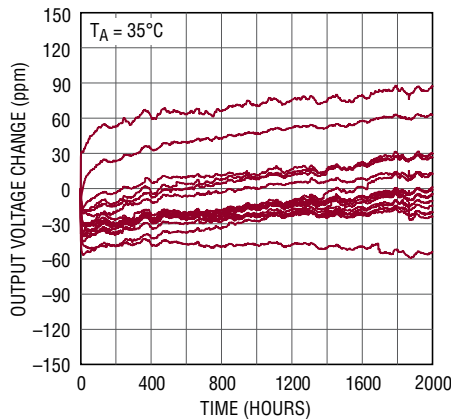

6654 G26

**2.5V Hysteresis Plot for -40°C  
and 125°C (LS8)**

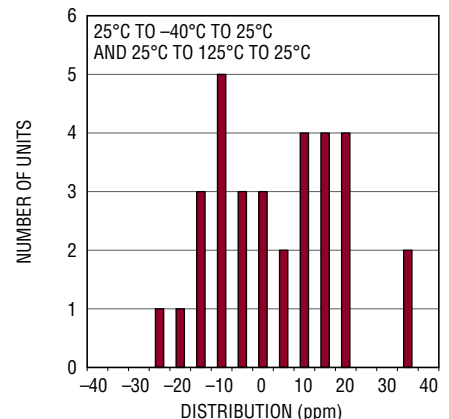

6654 G37

**TYPICAL PERFORMANCE CHARACTERISTICS** The characteristic curves are similar across the LT6654 family. Curves from the LT6654-1.25, LT6654-2.5 and the LT6654-5 represent the full range of typical performance of all voltage options. Characteristic curves for other output voltages fall between these curves and can be estimated based on their output.

**2.5V Long Term Drift (LS8)**

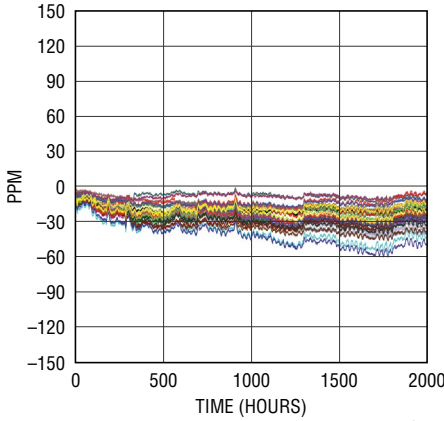

**2.5V Load Transient Response (Sinking)**

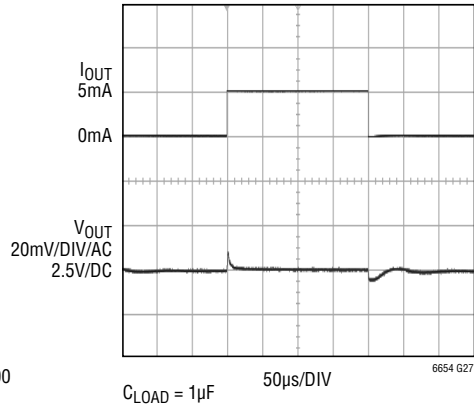

**5V Output Voltage Temperature Drift**

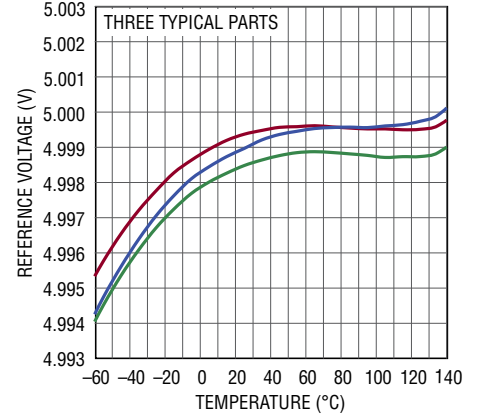

**5V Turn-On Characteristics**

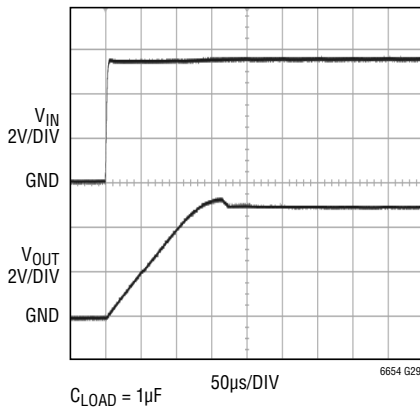

**5V Output Impedance vs Frequency**

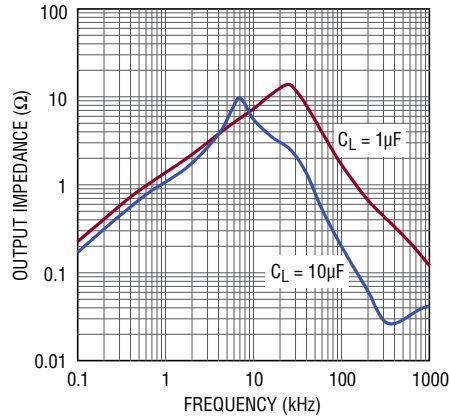

**5V Load Regulation (Sourcing)**

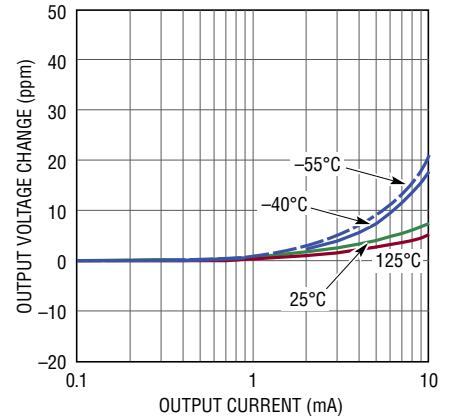

**5V Load Regulation (Sinking)**

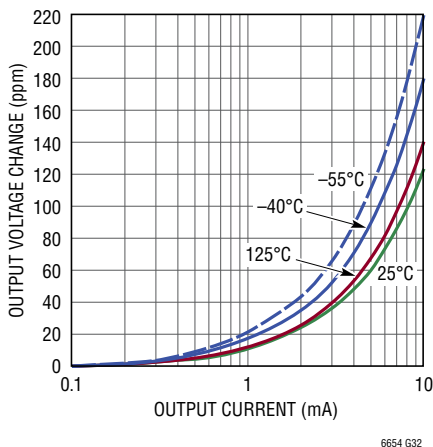

**5V Output Noise 0.1Hz to 10Hz**

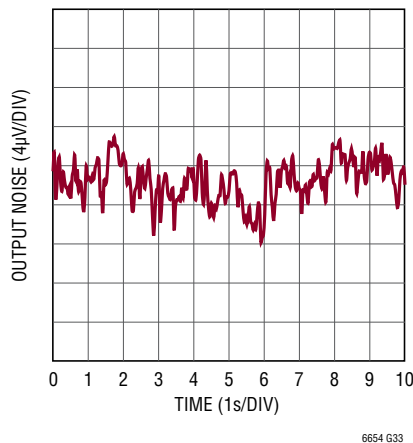

**5V Minimum V\_IN to V\_OUT Differential (Sourcing)**

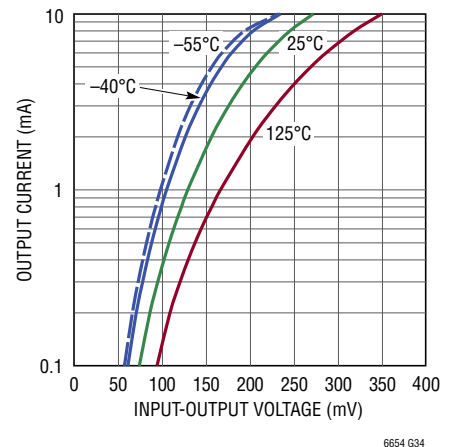

**TYPICAL PERFORMANCE CHARACTERISTICS** The characteristic curves are similar across the LT6654 family. Curves from the LT6654-1.25, LT6654-2.5 and the LT6654-5 represent the full range of typical performance of all voltage options. Characteristic curves for other output voltages fall between these curves and can be estimated based on their output.

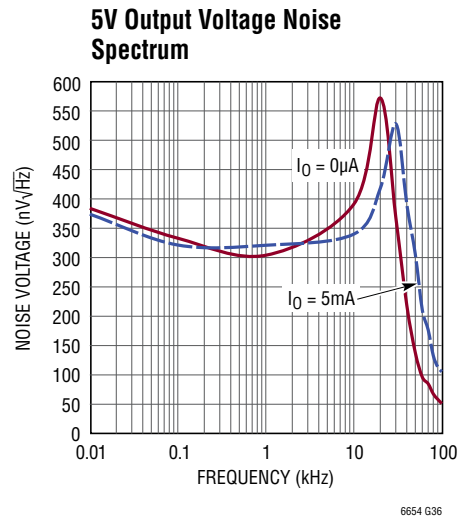
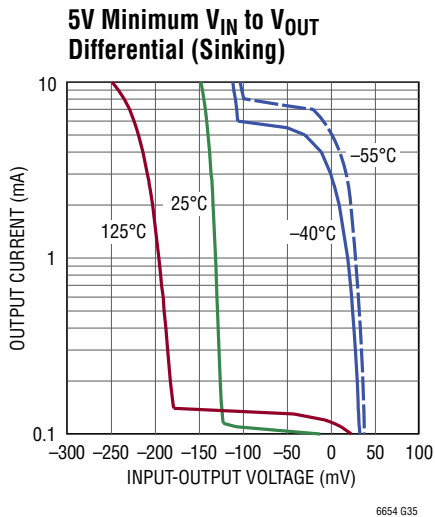

## PIN FUNCTIONS

(LS8)

**DNC (Pins 1, 7):** Do Not Connect. Keep leakage current from this pin to  $V_{IN}$  or GND to a minimum.

**NC (Pin 2):** Not internally connected. May be tied to  $V_{IN}$ ,  $V_{OUT}$ , GND or floated.

**GND (Pin 3):** Internal Function. This pin must be tied to GND near Pin 4.

**GND (Pin 4):** Primary Device Ground. Pin 3 and the load ground should be star-connected to Pin 4.

**$V_{OUT}$  (Pin 5):**  $V_{OUT}$  Pin. An output capacitor of  $1\mu F$  or greater is required for stable operation.

**$V_{OUT}$  (Pin 6):**  $V_{OUT}$  Pin. Tie to Pin 5 for proper load regulation.

**$V_{IN}$  (Pin 8):** Power Supply. Bypass  $V_{IN}$  with a  $0.1\mu F$ , or larger, capacitor to GND.

(TSOT)

**GND (Pin 1):** Internal Function. This pin must be tied to ground, near Pin 2.

**GND (Pin 2):** Primary Device Ground.

**DNC (Pin 3):** Do Not Connect. Keep leakage current from this pin to  $V_{IN}$  or GND to a minimum.

**$V_{IN}$  (Pin 4):** Power Supply. Bypass  $V_{IN}$  with a  $0.1\mu F$  capacitor to ground.

**DNC (Pin 5):** Do Not Connect. Keep leakage current from this pin to  $V_{IN}$  or GND to a minimum.

**$V_{OUT}$  (Pin 6):** Output Voltage. An output capacitor of  $1\mu F$  minimum is required for stable operation.

**BLOCK DIAGRAMS**

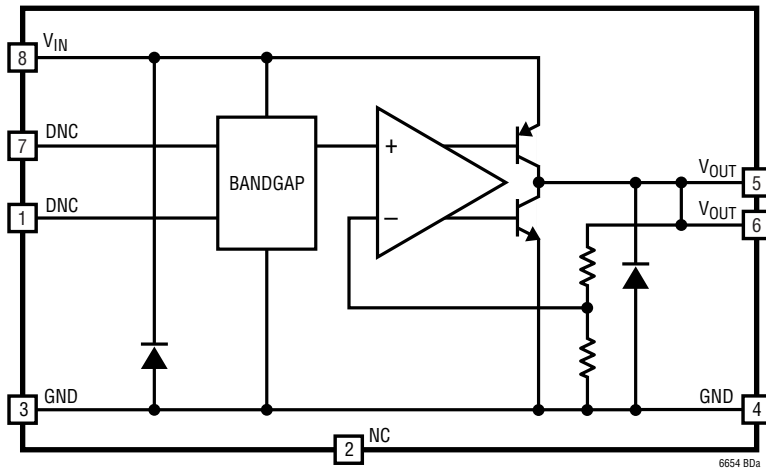

**LS8**

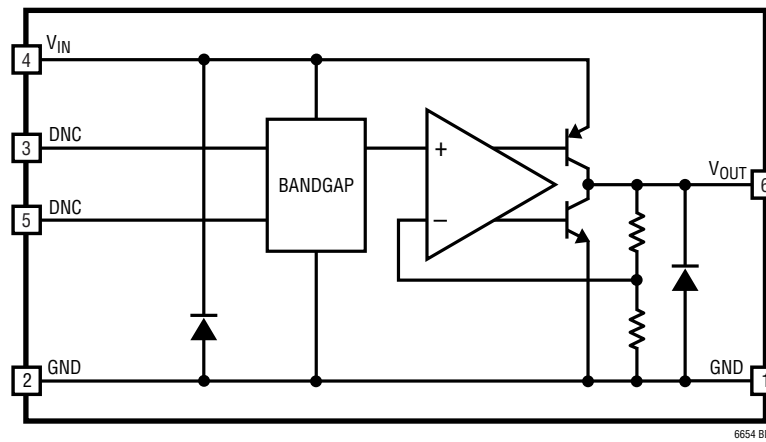

**SOT23**

## APPLICATIONS INFORMATION

### Bypass and Load Capacitors

The LT6654 voltage references should have an input bypass capacitor of  $0.1\mu\text{F}$  or larger, however the bypassing on other components nearby is sufficient. In high voltage applications,  $V_{\text{IN}} > 30\text{V}$ , an output short-circuit to ground can create an input voltage transient that could exceed the maximum input voltage rating. To prevent this worst-case condition, an RC input line filter of  $10\mu\text{s}$  (i.e.  $10\Omega$  and  $1\mu\text{F}$ ) is recommended. These references also require an output capacitor for stability. The optimum output capacitance for most applications is  $1\mu\text{F}$ , although larger values work as well. This capacitor affects the turn-on and settling time for the output to reach its final value.

Figure 1 shows the turn-on time for the LT6654-2.5 with a  $0.1\mu\text{F}$  input bypass and  $1\mu\text{F}$  load capacitor. Figure 2 shows the output response to a  $0.5\text{V}$  transient on  $V_{\text{IN}}$  with the same capacitors.

The test circuit of Figure 3 is used to measure the stability with various load currents. With  $R_{\text{L}} = 1\text{k}$ , the  $1\text{V}$  step produces a current step of  $1\text{mA}$ . Figure 4 shows the response to a  $\pm 0.5\text{mA}$  load. Figure 5 is the output response to a sourcing step from  $4\text{mA}$  to  $5\text{mA}$ , and Figure 6 is the output response of a sinking step from  $4\text{mA}$  to  $5\text{mA}$ .

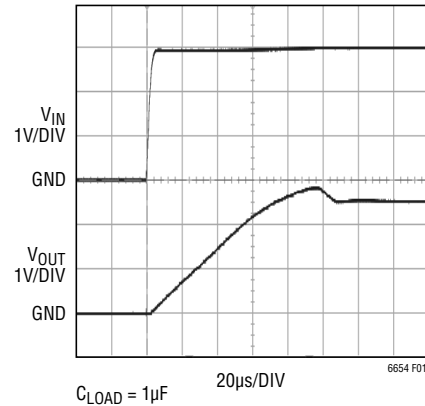

Figure 1. Turn-On Characteristics of LT6654-2.5

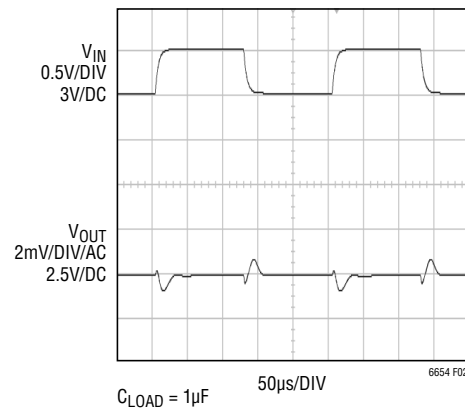

Figure 2. Output Response to  $0.5\text{V}$  Ripple on  $V_{\text{IN}}$

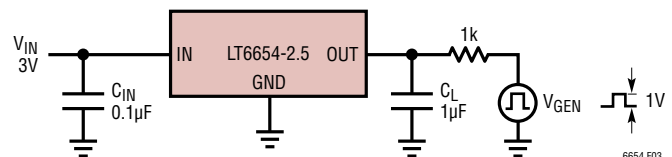

Figure 3. Load Current Response Time Test Circuit

## APPLICATIONS INFORMATION

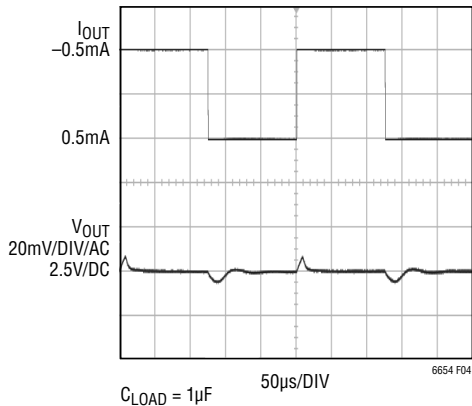

Figure 4. LT6654-2.5 Sourcing and Sinking 0.5mA

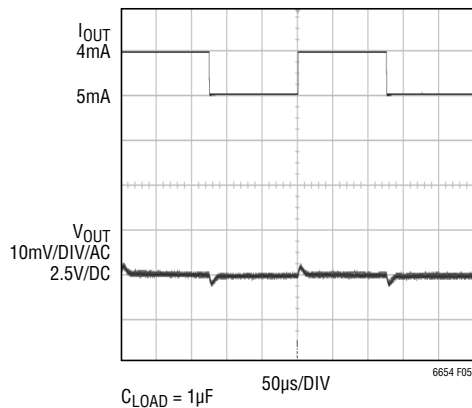

Figure 5. LT6654-2.5 Sourcing 4mA to 5mA

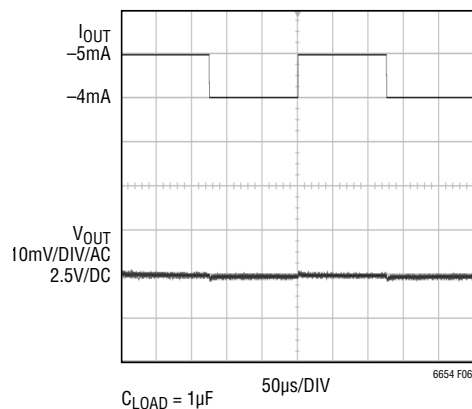

Figure 6. LT6654-2.5 Sinking 4mA to 5mA

### Positive or Negative Operation

In addition to the series connection, as shown on the front page of this data sheet, the LT6654 can be operated as a negative voltage reference.

The circuit in Figure 7 shows an LT6654 configured for negative operation. In this configuration, a positive voltage is required at  $V_{IN}$  (Pin 4) to bias the LT6654 internal circuitry. This voltage must be current limited with R1 to keep the output PNP transistor from turning on and driving the grounded output. C1 provides stability during load transients. This connection maintains the same accuracy and temperature coefficient of the positive connected LT6654.

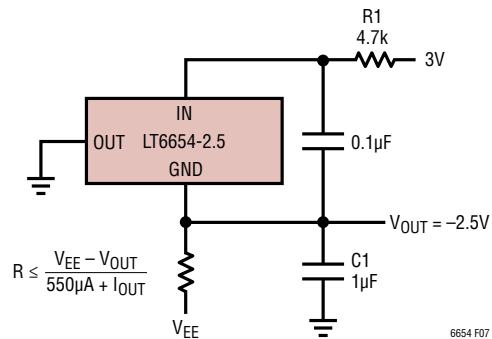

Figure 7. Using the LT6654-2.5 to Build a -2.5V Reference

## APPLICATIONS INFORMATION

### Long-Term Drift

Long-term drift cannot be extrapolated from accelerated high temperature testing. This erroneous technique gives drift numbers that are wildly optimistic. The only way long-term drift can be determined is to measure it over the time interval of interest. The LT6654 drift data was taken on 40 parts that were soldered into PC boards

similar to a real world application. The boards were then placed into a constant temperature oven with  $T_A = 35^\circ\text{C}$ , their outputs scanned regularly and measured with an 8.5 digit DVM. Long-term drift curves are shown in Figure 8. Their drift is much smaller after the first thousand hours.

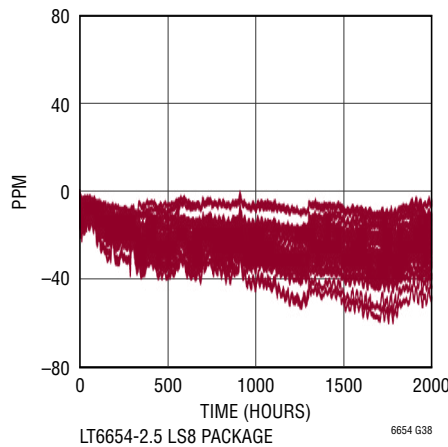
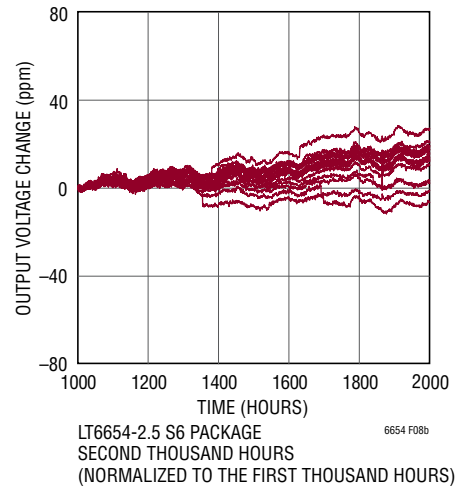
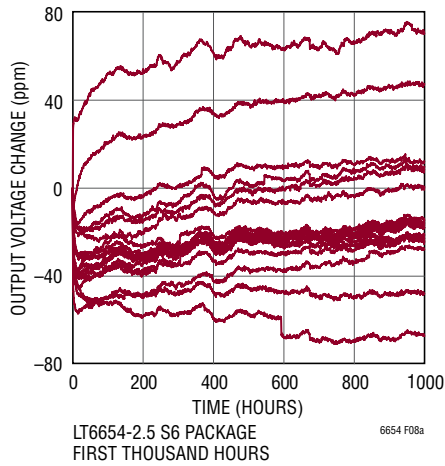

Figure 8. LT6654-2.5 Long Term Drift

## APPLICATIONS INFORMATION

### Power Dissipation

The power dissipation in the LT6654 is dependent on  $V_{IN}$ , load current and the package. The LT6654 package has a thermal resistance, or  $\theta_{JA}$ , of  $192^{\circ}\text{C}/\text{W}$ . A curve that illustrates allowed power dissipation versus temperature for the 6-lead SOT-23 package is shown in Figure 9. The power dissipation of the LT6654-2.5 as a function of input voltage is shown in Figure 10. The top curve shows power dissipation with a 10mA load and the bottom curve shows power dissipation with no load. When operated within its specified limits of  $V_{IN} = 36\text{V}$  and sourcing 10mA, the LT6654-2.5 consumes about 335mW at room temperature. The power-derating curve in Figure 9 shows the LT6654-2.5 can only safely dissipate 130mW at  $125^{\circ}\text{C}$ , which is less than its maximum power output. Care must be taken when designing the circuit so that the maximum junction temperature is not exceeded. For best performance, junction temperature should be kept below  $125^{\circ}\text{C}$ .

The LT6654 includes output current limit circuitry, as well as thermal limit circuitry, to protect the reference from damage in the event of excessive power dissipation. The LT6654 is protected from damage by a thermal shutdown circuit. However, changes in performance may occur as a result of operation at high temperature.

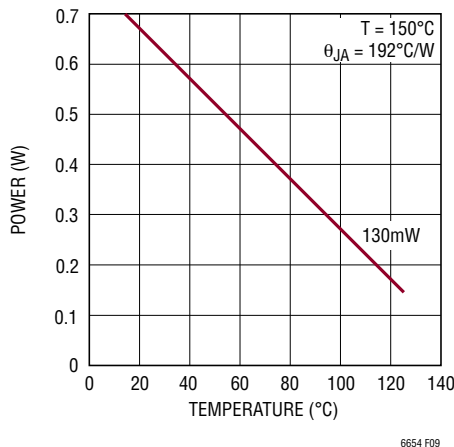

Figure 9. Maximum Allowed Power Dissipation of the LT6654

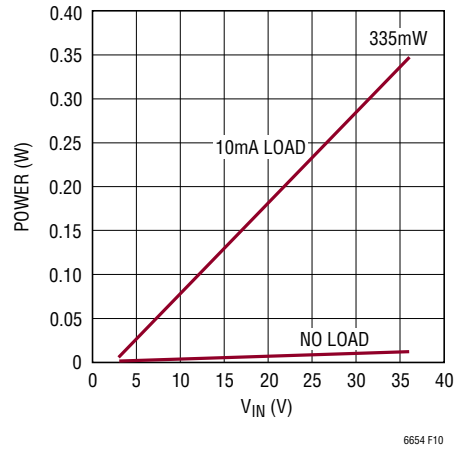
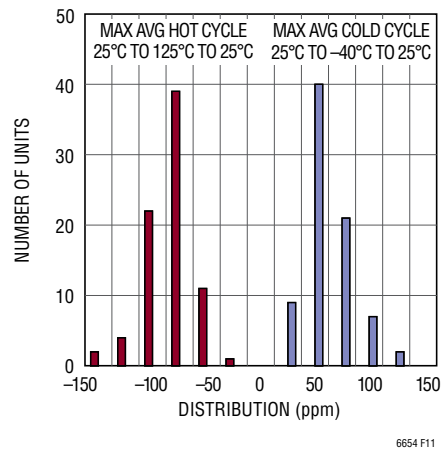
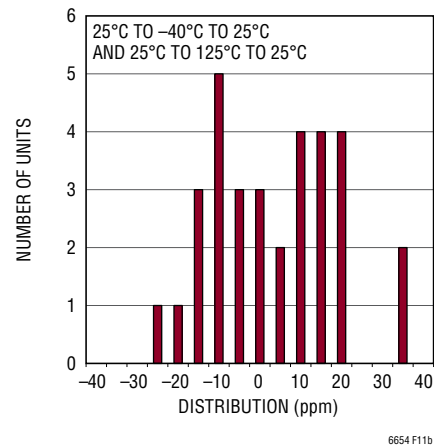

Figure 10. Typical Power Dissipation of the LT6654



(a) LT6654 S6 Thermal Hysteresis  $-40^{\circ}\text{C}$  to  $125^{\circ}\text{C}$



(b) LT6654 LS8 Thermal Hysteresis  $-40^{\circ}\text{C}$  to  $125^{\circ}\text{C}$

Figure 11.

## APPLICATIONS INFORMATION

### Hysteresis

The hysteresis data is shown in Figure 11. The LT6654 is capable of dissipating relatively high power. For example, with a 36V input voltage and 10mA load current applied to the LT6654-2.5, the power dissipation is  $P_D = 33.5V \cdot 10mA = 335mW$ , which causes an increase in the die temperature of 64°C. This could increase the junction temperature above 125°C ( $T_{JMAX}$  is 150°C) and may cause the output to shift due to thermal hysteresis.

### PC Board Layout

The mechanical stress of soldering a surface mount voltage reference to a PC board can cause the output voltage to shift and temperature coefficient to change. These two changes are not correlated. For example, the voltage may shift but the temperature coefficient may not.

To reduce the effects of stress-related shifts, mount the reference near the short edge of the PC board or in a corner. In addition, slots can be cut into the board on two sides of the device.

The capacitors should be mounted close to the LT6654. The GND and  $V_{OUT}$  traces should be as short as possible to minimize  $I \cdot R$  drops, since high trace resistance directly impacts load regulation.

### IR Reflow Shift

The different expansion and contraction rates of the materials that make up the LT6654 package may cause the output voltage to shift after undergoing IR reflow. Lead free solder reflow profiles reach over 250°C, considerably more than with lead based solder. A typical lead free IR reflow profile is shown in Figure 12. Similar profiles are found using a convection reflow oven. LT6654 devices run up to three times through this reflow process show that the standard deviation of the output voltage increases with a slight negative mean shift of 0.003% as shown in Figure 13. While there can be up to 0.014% of output voltage shift, the overall drift of the LT6654 after IR reflow does not vary significantly.

### Humidity Sensitivity

Plastic mould compounds absorb water. With changes in relative humidity, plastic packaging materials change the amount of pressure they apply to the die inside, which can cause slight changes in the output of a voltage reference, usually on the order of 100ppm. The LS8 package is hermetic, so it is not affected by humidity, and is therefore more stable in environments where humidity may be a concern.

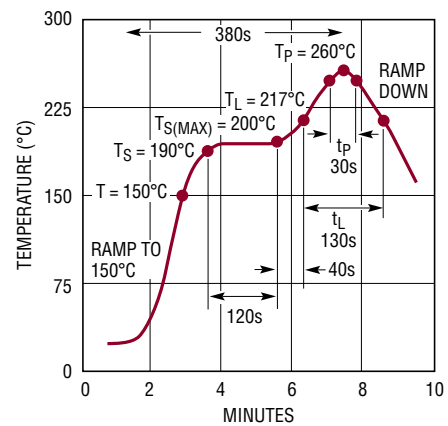

6654 F12

Figure 12. Lead Free Reflow Profile

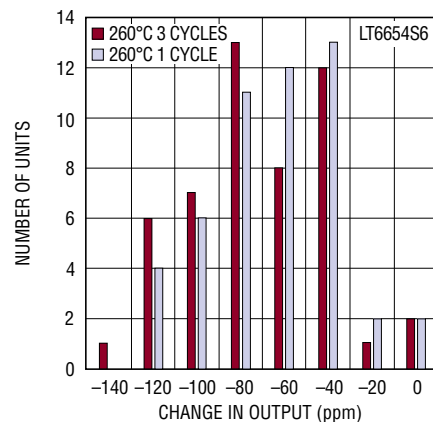

6654 F13

Figure 13. Output Voltage Shift Due to IR Reflow (%)

**TYPICAL APPLICATIONS**

**Extended Supply Range Reference**

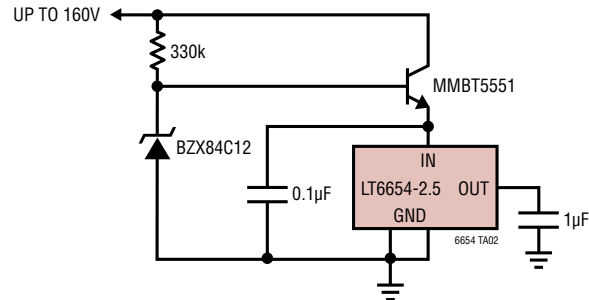

**Boosted Output Current Reference**

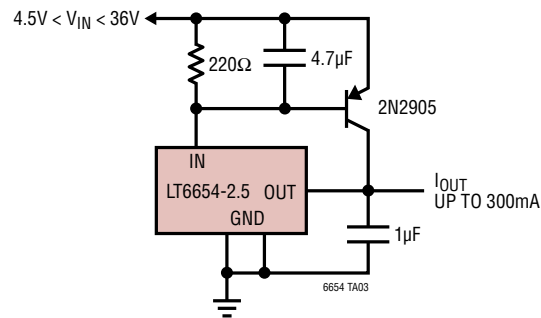

**TYPICAL APPLICATIONS**

**Boosted Output Current with Current Limit**

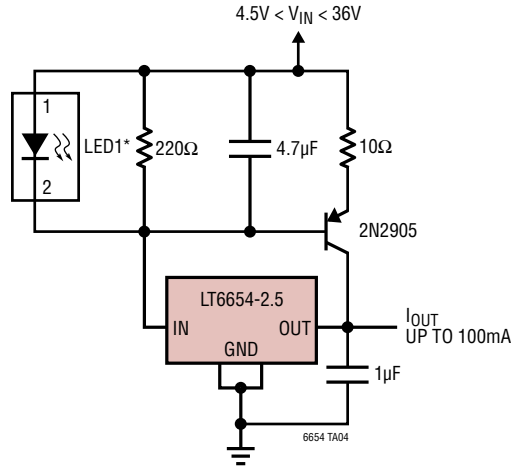

\* LED CANNOT BE OMITTED  
THE LED CLAMPS THE VOLTAGE  
DROP ACROSS THE 220Ω AND  
LIMITS OUTPUT CURRENT

**Octal DAC Reference**

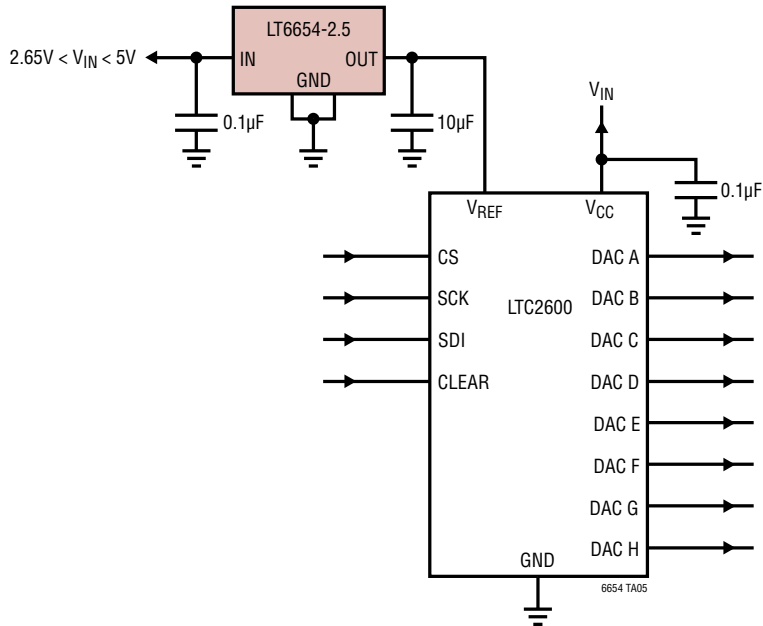

# PACKAGE DESCRIPTION

## S6 Package 6-Lead Plastic TSOT-23 (Reference LTC DWG # 05-08-1636)

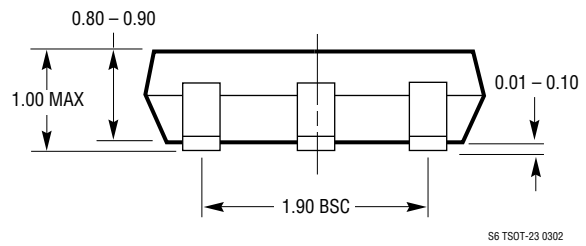
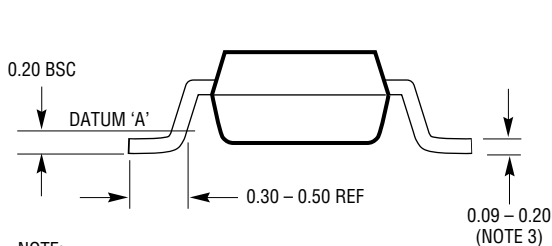
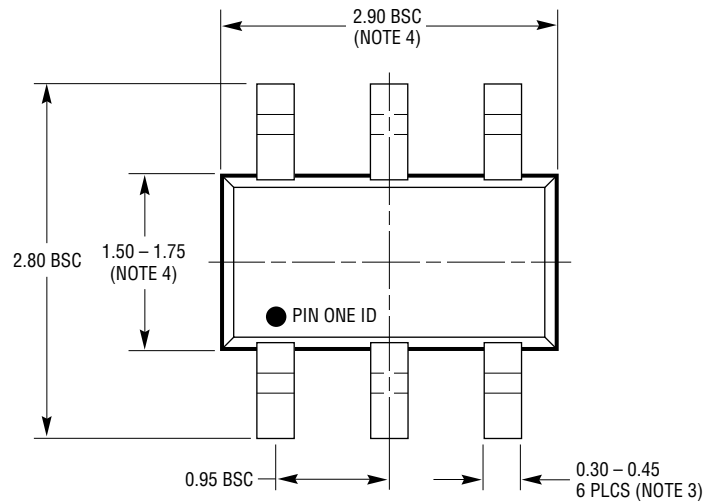
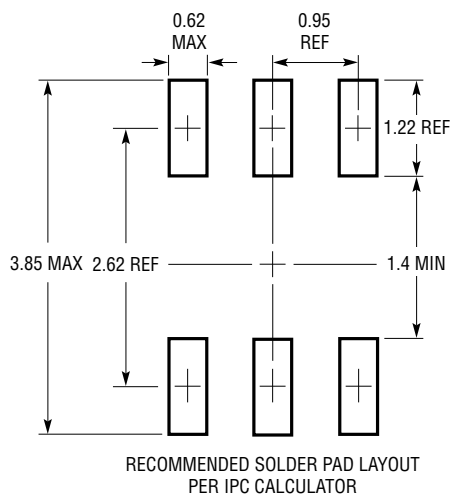

- NOTE:
1. DIMENSIONS ARE IN MILLIMETERS
  2. DRAWING NOT TO SCALE
  3. DIMENSIONS ARE INCLUSIVE OF PLATING
  4. DIMENSIONS ARE EXCLUSIVE OF MOLD FLASH AND METAL BURR
  5. MOLD FLASH SHALL NOT EXCEED 0.254mm
  6. JEDEC PACKAGE REFERENCE IS MO-193

S6 TSOT-23 0302

**PACKAGE DESCRIPTION**

**LS8 Package**  
**8-Pin Leadless Chip Carrier (5mm × 5mm)**  
 (Reference LTC DWG # 05-08-1852 Rev B)

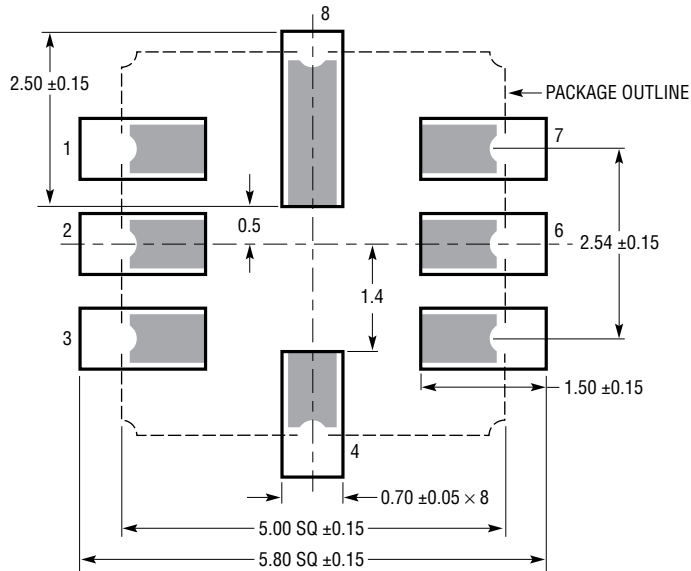

APPLY SOLDER MASK TO AREAS THAT ARE NOT SOLDERED

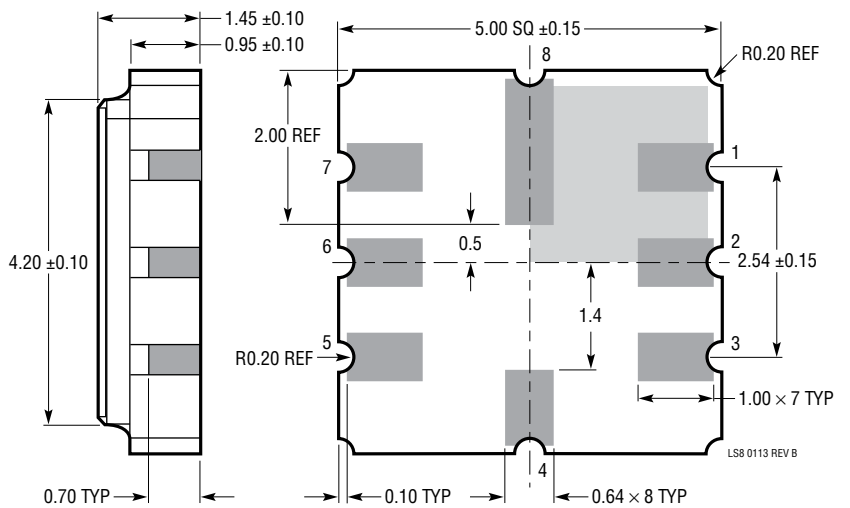
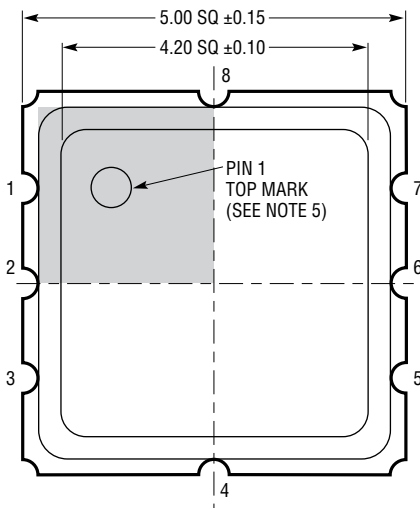
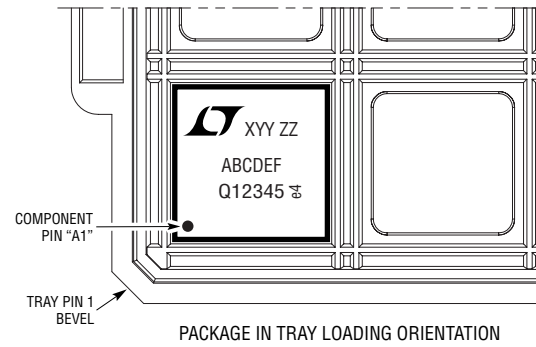

- NOTE:
1. ALL DIMENSIONS ARE IN MILLIMETERS
  2. DRAWING NOT TO SCALE
  3. DIMENSIONS PACKAGE DO NOT INCLUDE PLATING BURRS  
 PLATING BURRS, IF PRESENT, SHALL NOT EXCEED 0.30mm ON ANY SIDE
  4. PLATING—ELECTO NICKEL MIN 1.25UM, ELECTRO GOLD MIN 0.30UM
  5. SHADED AREA IS ONLY A REFERENCE FOR PIN 1 LOCATION ON THE TOP AND BOTTOM OF PACKAGE

## REVISION HISTORY

| REV | DATE  | DESCRIPTION   | PAGE NUMBER                                 |
|-----|-------|---|---|
| A   | 12/10 | Added voltage options (1.250V, 2.048V, 3.000V, 4.096V, 5.000V) reflected throughout the data sheet.   | 1-18  |
| B   | 3/11  | Revised conditions for Output Voltage Noise in the Electrical Characteristics section.  | 4   |
| C   | 8/12  | Addition of LS8 Features and Order Information.<br>Update to Electrical Characteristics to Include LS8 Package.<br>Addition of Long Term Drift and Hysteresis Plots for LS8 Package.<br>Addition of Humidity Sensitivity Information.<br>Addition of LS8 Package Description.<br>Addition of Related Parts. | 1, 2, 4<br>6<br>9, 15, 16<br>17<br>20<br>22 |
| D   | 2/14  | Schematics updated to refer to pin functions instead of pin numbers.<br>Label of Pin 2 on LS8 package changed to NC.<br>The pin descriptions of Pin 2, Pin 3 and Pin 4 on LS8 package changed.<br>GND label added on all schematic references of LT6654.  | 1, 13, 14, 18<br>2, 11, 12<br>11<br>18, 22  |
| E   | 6/15  | SOT-23 removed from data sheet title.<br>Order Information updated to include 2.048V, 4.096V and 5V option in LS8 package.  | 1<br>3, 4                                   |
| F   | 12/15 | Part marking correction for 4.096V options in TSOT-23 package.<br>Web link to Package Description updated.  | 3<br>19, 20                                 |
| G   | 03/17 | Added 2.5V option in I-temp grade.  | 2-5   |
| H   | 05/17 | Added 1.25V, 2.048V, 3V, 3.3V, 4.096V and 5V Option in I-temp grade.  | 2-5   |
| I   | 05/20 | Added Automotive Grades for all voltage options.  | 1-3   |

## TYPICAL APPLICATION

### 16-Bit ADC Reference

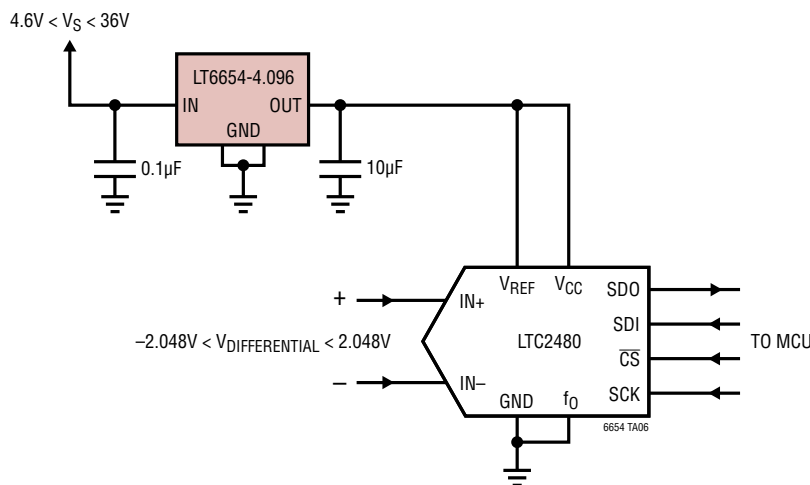



## RELATED PARTS

| PART NUMBER             | DESCRIPTION                                      | COMMENTS  |
|-------------------------|--|---|
| <a href="#">LT1460</a>  | Micropower Series Reference                      | 0.075% Max, 10ppm/°C Max Drift, 2.5V, 5V and 10V Versions, MSOP, PDIP, SO-8, SOT-23 and TO-92 Packages  |
| <a href="#">LT1461</a>  | Micropower Precision LDO Series Reference        | 3ppm/°C Max Drift, 0°C to 70°C, -40°C to 85°C, -40°C to 125°C Options in SO-8                           |
| <a href="#">LT1790</a>  | Micropower Precision Series References           | 0.05% Max, 10ppm/°C Max, 60µA Supply, SOT-23 Package  |
| <a href="#">LT6650</a>  | Micropower Reference with Buffer Amplifier       | 0.05% Max, 5.6µA Supply, SOT-23 Package   |
| <a href="#">LTC6652</a> | Precision Low Drift Low Noise Buffered Reference | 0.5% Max, 5ppm/°C Max, 2.1ppm <sub>P-P</sub> Noise (0.1Hz to 10Hz) 100% Tested at -40°C, 25°C and 125°C |
| <a href="#">LT6660</a>  | Tiny Micropower Series Reference                 | 0.2% Max, 20ppm/°C Max, 20mA Output Current, 2mm × 2mm DFN  |
| <a href="#">LTC6655</a> | Precision Low Noise Reference                    | 2ppm/°C Max, 650nV <sub>P-P</sub> Noise (0.1Hz to 10Hz) 100% Tested at -40°C, 25°C and 125°C            |
| <a href="#">LT6656</a>  | 800nA Precision Voltage Reference                | 800nA, 10ppm/°C Max, 0.05% Max, SOT-23 Package  |

## Looking for pricing, stock, or lifecycle information?

Click below to explore more details on WIN SOURCE:

-  [View LT6654AHS6-5#TRMPBF on WIN SOURCE](#)
-  [Analog Devices Inc. Information](#)

## Optimize Your Supply Chain with WIN SOURCE Solutions

-  Global Sourcing Solution
-  Obsolete Management
-  Cost Control Management
-  Shortage Management
-  Alternative Solution
-  Excess Inventory Management