



**THE DATASHEET OF
JANTX1N5643A/TR**



**1500 WATT UNIDIRECTIONAL
 TRANSIENT VOLTAGE SUPPRESSOR**
Qualified per MIL-PRF-19500/500

DEVICES

*** 1N5629 thru 1N5665
 1N5629A thru 1N5665A**

*** Commercial only**

LEVELS

**JAN
 JANTX
 JANTXV**

DESCRIPTION

This popular Transient Voltage Suppressor (TVS) series for 1N5629 thru 1N5665A are JEDEC registered selections for unidirectional devices. All have the same high Peak Pulse Power rating of 1500 W with extremely fast response times. They are also available in military qualified selections as described in the Features section herein. They are most often used for protecting against transients from inductive switching environments, induced RF effects, or induced secondary lightning effects as found in lower surge levels of IEC61000-4-5. They are also very successful in protecting airborne avionics and electrical systems. Since their response time is virtually instantaneous, they can also protect from ESD and EFT per IEC61000-4-2 and IEC61000-4-4.

IMPORTANT: For the most current data, consult *MICROSEMI's* website:

<http://www.microsemi.com>



DO-13 (DO-202AA)

FEATURES

- Unidirectional TVS series for thru-hole mounting
- Suppresses transients up to 1500 watts @ 10/1000 μ s (see Figure 1)
- Clamps transient in less than 100 pico seconds
- Working voltage (V_{WM}) range 5 V to 171 V
- Hermetic sealed DO-13 metal package
- JAN/TX/TXV military qualifications also available for the tighter tolerance "A" suffix devices per MIL-PRF-19500/500 by adding the JAN, JANTX, or JANTXV prefix, e.g. JANTXV1N5629A, etc.
- For bidirectional TVS in the same DO-13 package, see separate data sheet for the 1N6036 – 1N6072A series (also military qualified)
- Surface mount equivalent packages also available as SMCJ5.0 - SMCJ170CA or SMCG5.0 – SMCG170CA in separate data sheet (consult factory for other surface mount options)
- Plastic axial-leaded equivalents available in the 1N6267 – 1N6303A series in separate data sheet

APPLICATIONS / BENEFITS

- Protection from switching transients and induced RF
- ESD & EFT protection per IEC 61000-4-2 and -4-4
- Secondary lightning protection per IEC61000-4-5 with 42 Ohms source impedance:
 - Class 1: 1N5629 to 1N5665A
 - Class 2: 1N5629 to 1N5663A
 - Class 3: 1N5629 to 1N5655A
 - Class 4: 1N5629 to 1N5648A
- Secondary lightning protection per IEC61000-4-5 with 12 Ohms source impedance:
 - Class 1: 1N5629 to 1N5658A
 - Class 2: 1N5629 to 1N5651A
 - Class 3: 1N5629 to 1N5643A
 - Class 4: 1N5629 to 1N5636A
- Secondary lightning protection per IEC61000-4-5 with 2 Ohms source impedance:
 - Class 2: 1N5629 to 1N5642A
 - Class 3: 1N5629 to 1N5635A
- Inherently radiation hard per Microsemi MicroNote 050

MAXIMUM RATINGS

- 1500 Watts for 10/1000 μ s with repetition rate of 0.01% or less* at lead temperature (T_L) 25°C (see Figs 1, 2, & 4)
- Operating & Storage Temperatures: -65° to +175°C
- THERMAL RESISTANCE: 50°C/W junction to lead at 0.375 inches (10 mm) from body or 110°C/W junction to ambient when mounted on FR4 PC board with 4 mm² copper pads (1oz) and track width 1 mm, length 25 mm
- DC Power Dissipation*: 1 Watt at $T_L \leq +125^\circ\text{C}$ 3/8" (10 mm) from body (see derating in Fig 3 and note below)
- Forward surge current: 200 Amps for 8.3ms half-sine wave at $T_A = +25^\circ\text{C}$
- Solder Temperatures: 260 ° C for 10 s (maximum)

MECHANICAL AND PACKAGING

- CASE: DO-13 (DO-202AA), welded, hermetically sealed metal and glass
- FINISH: All external metal surfaces are Tin-Lead plated and solderable per MIL-STD-750 method 2026
- POLARITY: Cathode connected to case and polarity indicated by diode symbol
- MARKING: Part number and polarity diode symbol
- WEIGHT: 1.4 grams. (Approx)
- TAPE & REEL option: Standard per EIA-296 (add "TR" suffix to part number)
- See package dimension on last page

* TVS devices are not typically used for dc power dissipation and are instead operated at or less than their rated standoff voltage (V_{WM}) except for transients that briefly drive the device into avalanche breakdown (V_{BR} to V_C region).

ELECTRICAL CHARACTERISTICS @ T_A = 25°C

JEDEC Type No.*	Breakdown Voltage V _(BR) @ I _(BR)		Breakdown Current I _(BR)	Rated Standoff Voltage V _{WM}	Maximum Standby Current I _D @ V _{WM}	Maximum Clamping Voltage V _C @ I _{PP}	Maximum Peak Pulse Current I _{PP}	Maximum Temperature Coefficient of V _(BR) α _{V(BR)}
	Min.	Max.						
	V	V	mA	V	μA	V	A	%/°C
1N5629	6.12	7.48	10	5.50	1000	10.8	139	.057
1N5629A	6.45	7.14	10	5.80	1000	10.5	143	.057
1N5630	6.75	8.25	10	6.05	500	11.7	128	.061
1N5630A	7.13	7.88	10	6.40	500	11.3	132	.061
1N5631	7.38	9.02	10	6.63	200	12.5	120	.065
1N5631A	7.79	8.61	10	7.02	200	12.1	124	.065
1N5632	8.19	10.0	1	7.37	50	13.8	109	.068
1N5632A	8.65	9.55	1	7.78	50	13.4	112	.068
1N5633	9.00	11.0	1	8.10	10	15.0	100	.073
1N5633A	9.5	10.5	1	8.55	10	14.5	103	.073
1N5634	9.9	12.1	1	8.92	5	16.2	93	.075
1N5634A	10.5	11.6	1	9.40	5	15.6	96	.075
1N5635	10.8	13.2	1	9.72	5	17.3	87	.078
1N5635A	11.4	12.6	1	10.2	5	16.7	90	.078
1N5636	11.7	14.3	1	10.5	5	19.0	79	.081
1N5636A	12.4	13.7	1	11.1	5	18.2	82	.081
1N5637	13.5	16.5	1	12.1	5	22.0	68	.084
1N5637A	14.3	15.8	1	12.8	5	21.2	71	.084
1N5638	14.4	17.6	1	12.9	5	23.5	64	.086
1N5638A	15.2	16.8	1	13.6	5	22.5	67	.086
1N5639	16.2	19.8	1	14.5	5	26.5	56.5	.088
1N5639A	17.1	18.9	1	15.3	5	25.2	59.5	.088
1N5640	18.0	22.0	1	16.2	5	29.1	51.5	.090
1N5640A	19.0	21.0	1	17.1	5	27.7	54	.090
1N5641	19.8	24.2	1	17.8	5	31.9	47	.092
1N5641A	20.9	23.1	1	18.8	5	30.6	49	.092
1N5642	21.6	26.4	1	19.4	5	34.7	43	.094
1N5642A	22.8	25.2	1	20.5	5	33.2	45	.094
1N5643	24.3	29.7	1	21.8	5	39.1	38.5	.096
1N5643A	25.7	28.4	1	23.1	5	37.5	40	.096
1N5644	27.0	33.0	1	24.3	5	43.5	34.5	.097
1N5644A	28.5	31.5	1	25.6	5	41.4	36	.097
1N5645	29.7	36.3	1	26.8	5	47.7	31.5	.098
1N5645A	31.4	34.7	1	28.2	5	45.7	33	.098
1N5646	32.4	39.6	1	29.1	5	52.0	29	.099
1N5646A	34.2	37.8	1	30.8	5	49.9	30	.099
1N5647	35.1	42.9	1	31.6	5	56.4	26.5	.100
1N5647A	37.1	41.0	1	33.3	5	53.9	28	.100
1N5648	38.7	47.3	1	34.8	5	61.9	24	.101
1N5648A	40.9	45.2	1	36.8	5	59.3	25.3	.101
1N5649	42.3	51.7	1	38.1	5	67.8	22.2	.101
1N5649A	44.7	49.4	1	40.2	5	64.8	23.2	.101
1N5650	45.9	56.1	1	41.3	5	73.5	20.4	.102
1N5650A	48.5	53.6	1	43.6	5	70.1	21.4	.102
1N5651	50.4	61.6	1	45.4	5	80.5	18.6	.103
1N5651A	53.2	58.8	1	47.8	5	77.0	19.5	.103
1N5652	55.8	68.2	1	50.2	5	89.0	16.9	.104
1N5652A	58.9	65.1	1	53.0	5	85.0	17.7	.104
1N5653	61.2	74.8	1	55.1	5	98.0	15.3	.104
1N5653A	64.6	71.4	1	58.1	5	92.0	16.3	.104
1N5654	67.5	82.5	1	60.7	5	108	13.9	.105
1N5654A	71.3	78.8	1	64.1	5	103	14.6	.105
1N5655	73.8	90.2	1	66.4	5	118	12.7	.105
1N5655A	77.9	86.1	1	70.1	5	113	13.3	.105
1N5656	81.9	100.0	1	73.7	5	131	11.4	.106
1N5656A	86.5	95.5	1	77.8	5	125	12.0	.106
1N5657	90	110	1	81.0	5	144	10.4	.106
1N5657A	95	105	1	85.5	5	137	11.0	.106
1N5658	99	121	1	89.2	5	158	9.5	.107
1N5658A	105	116	1	94.0	5	152	9.9	.107
1N5659	108	132	1	97.2	5	173	8.7	.107
1N5659A	114	126	1	102	5	165	9.1	.107
1N5660	117	143	1	105	5	187	8.0	.107
1N5660A	124	137	1	111	5	179	8.4	.107

ELECTRICAL CHARACTERISTICS @ $T_A = 25^\circ\text{C}$

JEDEC Type No.*	Breakdown Voltage $V_{(BR)}$ @ $I_{(BR)}$		Breakdown Current $I_{(BR)}$	Rated Standoff Voltage V_{WM}	Maximum Standby Current I_D @ V_{WM}	Maximum Clamping Voltage V_C @ I_{PP}	Maximum Peak Pulse Current I_{PP}	Maximum Temperature Coefficient of $V_{(BR)}$ $\alpha_{V(BR)}$
	Min.	Max.						
	V	V	mA	V	μA	V	A	%/ $^\circ\text{C}$
1N5661	135	165	1	121	5	215	7.0	.108
1N5661A	143	158	1	128	5	207	7.2	.108
1N5662	144	176	1	130	5	230	6.5	.108
1N5662A	152	168	1	136	5	219	6.8	.108
1N5663	153	187	1	138	5	244	6.2	.108
1N5663A	162	179	1	145	5	234	6.4	.108
1N5664	162	198	1	146	5	258	5.8	.108
1N5664A	171	189	1	154	5	246	6.1	.108
1N5665	180	220	1	162	5	287	5.2	.108
1N5665A	190	210	1	171	5	274	5.5	.108

NOTE 1: A TVS is normally selected according to the rated “Standoff Voltage” V_{WM} that should be equal to or greater than the dc or continuous peak operating voltage level.

NOTE 2: Also available in military qualified types with a JAN, JANTX, or JANTXV prefix.

SYMBOLS & DEFINITIONS

Symbol	Definition
V_{WM}	Standoff Voltage: Applied Reverse Voltage to assure a nonconductive condition. (See Note 1 above.)
$V_{(BR)}$	Breakdown Voltage: This is the Breakdown Voltage the device will exhibit at 25°C
V_C	Maximum Clamping Voltage: The maximum peak voltage appearing across the TVS when subjected to the peak pulse current in a one millisecond time interval. The peak pulse voltage is the combination of voltage rise due to both the series resistance and thermal rise and positive temperature coefficient ($\alpha_{V(BR)}$)
I_{PP}	Peak Pulse Current: The peak current during the impulse (See Figure 2)
P_{PP}	Peak Pulse Power: The pulse power as determined by the product of V_C and I_{PP}
I_D	Standby Current: The current at the standoff voltage (V_{WM})
$I_{(BR)}$	Breakdown Current: The current used for measuring Breakdown Voltage ($V_{(BR)}$)

GRAPHS

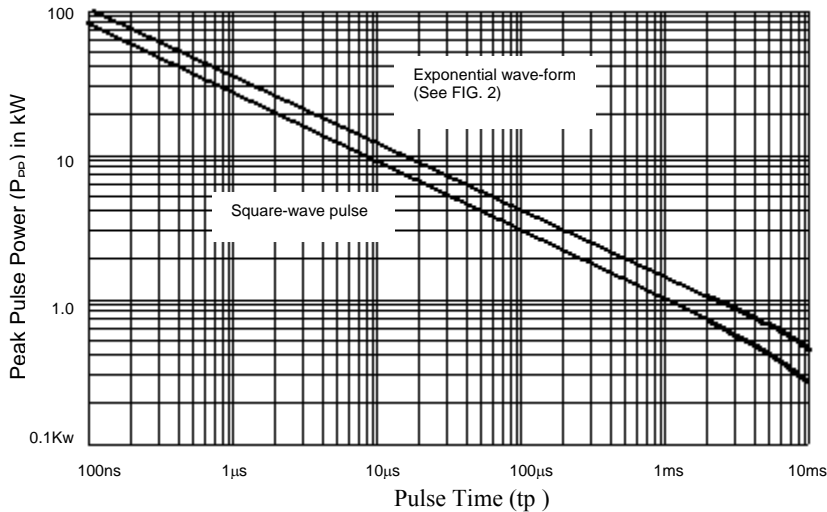

FIG. 1 – Non-repetitive peak pulse power rating curve
 NOTE: Peak power defined as peak voltage times peak current

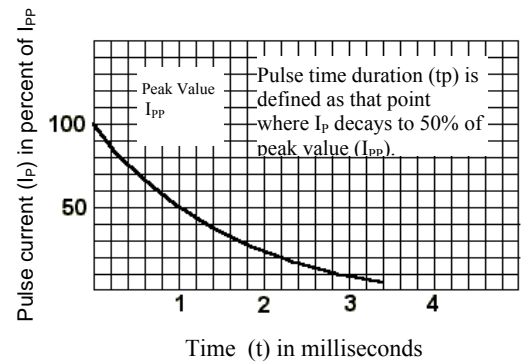

FIG. 2 Pulse wave form for exponential surge

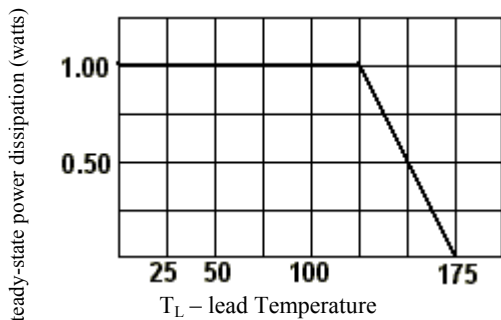
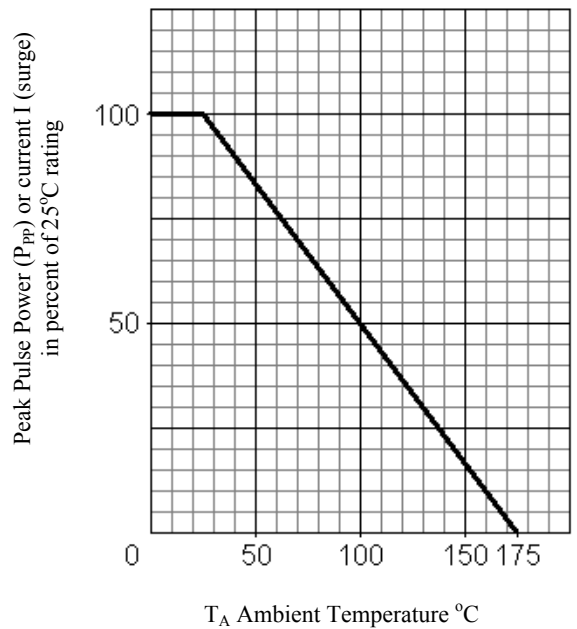

FIG. 3 Steady-state power derating curve



T_A Ambient Temperature °C

FIG. 4 Derating Curve

PACKAGE DIMENSIONS

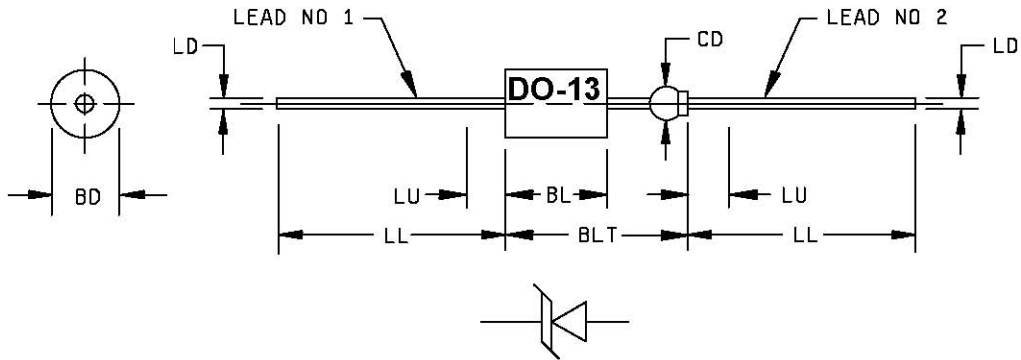

NOTES:



1. Dimensions are in inches.
2. Millimeters are given for general information only.
3. The major diameter is essentially constant along its length.
4. Within this zone, diameter may vary to allow for lead finishes and irregularities.
5. Dimension to allow for pinch or seal deformation anywhere along tubulation.
6. Lead 1 (cathode) shall be electrically connected to the case.
7. In accordance with ASME Y14.5M, diameters are equivalent to ϕ x symbology.

Symbol	Dimensions				Notes
	Inches		Millimeters		
	Min	Max	Min	Max	
BD	.215	.235	5.46	5.97	
BL	.293	.357	7.44	9.07	3
BLT		.570		14.48	
CD	.045	.100	1.14	2.54	5
LD	.025	.035	0.64	0.89	
LL	1.000	1.625	25.40	41.28	4
LU		.188		4.78	4

FIGURE 1. Physical dimensions (DO-13).

Looking for pricing, stock, or lifecycle information?

Click below to explore more details on WIN SOURCE:

-  [View JANTX1N5643A/TR on WIN SOURCE](#)
-  [Microchip Technology](#) Information

Optimize Your Supply Chain with WIN SOURCE Solutions

-  Global Sourcing Solution
-  Obsolete Management
-  Cost Control Management
-  Shortage Management
-  Alternative Solution
-  Excess Inventory Management