

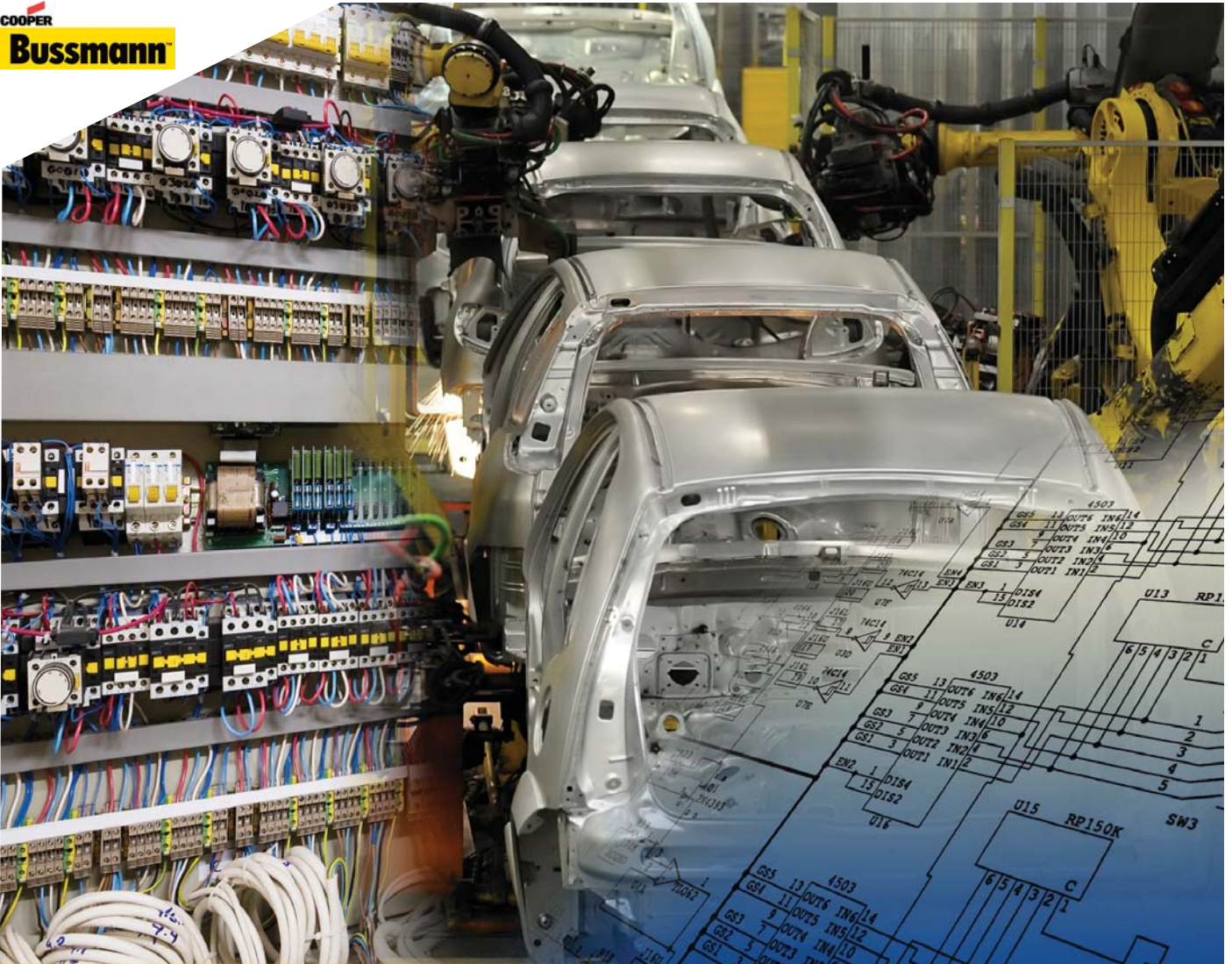

THE DATASHEET OF CSC-2-510P





DIN-Rail Terminal Blocks

Simplify Wiring, Power Distribution
& Circuit Protection

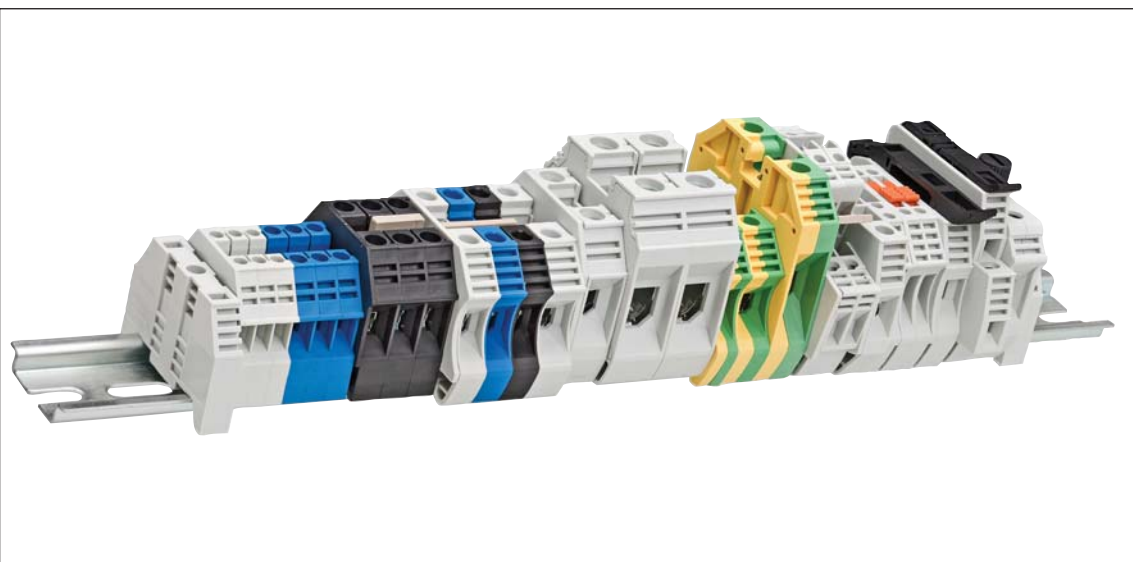



Terminal Blocks



Accessories



Marking System

Terminal Blocks

Terminal Blocks Styles		4 - 5
Terminal Blocks Overview		5
Feed Through Blocks	DP Series	6 - 7
	DS Series	8
Mini Feed Through Blocks	DM Series	9
Double Level Blocks	DDP Series	10
Disconnect Blocks	DIS Series	10
Grounding Blocks	DG Series	11 - 12
Fuse Holder Blocks	F520 Series	13 - 14
Internally Jumpered Blocks	DDNS Series	14
Test Blocks	DTST2 Series	15

Accessories

Top Screw-on Bridges		16
End Brackets		17
Partition Plates		17
Jumper Slides		18
Top Insertion Bridges		18
Side Insertion Bridges		19 - 20
Mounting Rails		20

BUSS*Scribe* Marking Systems

Marking System		22
Marking Label Ordering Method		23 - 25

DIN-Rail Complementary Range

Overview		26
Modular Fuse Holders	CH Series	27
	Comb-Bus Bar	28
	CH-PLC	29
	CH14B Series	30
	CH22B Series	31
Compact Circuit Protectors	CCP Series	32
NH Bases		33
Surge Protective Devices		34 - 35

Terminal Blocks Styles

Our terminal blocks are available in multiple colours for easy circuit identification, plus popular single and double-bridge shaft systems for maximum power distribution flexibility. Certifications include UL 1059 (UL File E62622), cURus, VDE and IEC 60947-7. Blocks are Short-Circuit Current Rated (SCCR) from 10kA to 200kA.

Feed Through Terminal Blocks



Single-level feed through terminal blocks up to 1000V and 232A for wire sizes AWG 22 to 2 (0.5mm² to 35mm²).

See page 6 - 9

Fuse Holder Terminal Blocks



Fuse terminal blocks protect your sensors and relays. Available in lever and screw-cap style, with and without LED indication. Uses standard Cooper Bussmann 5x20mm fuse links.

See page 13 - 14

Double Level Terminal Blocks

High-density connectivity using double-level terminal blocks. Marking system, side insertion bridge and top screw-on bridge are standard. Use bridges to achieve any connection topology.



See page 10

Internally Jumpered Terminal Blocks

Internally jumpered double-level terminal blocks provide high-density power distribution in 3-in/1-out or 2-in/2-out or 1-in/3-out options with a single block.

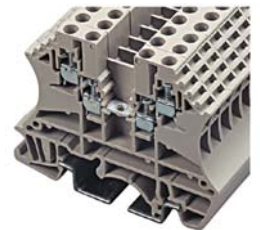

See page 14

Disconnect Terminal Blocks

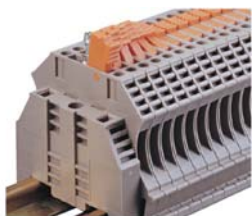

Disconnect terminal blocks offer an easy circuit disconnection with just a flick of a screwdriver.

See page 10

Test Terminal Blocks



Test terminal blocks with convenient test sockets, plugs, jumpers and accessories to make your circuit troubleshooting easy.

See page 15

Grounding Terminal Blocks

Grounding terminal blocks can convert DIN-Rail into a grounding bar. For wire sizes AWG 26 to 2 (0.13mm² to 35mm²).



See page 11 - 12

Jumper Bridges

A variety of side insertion bridge, top insertion bridge and top screw-on bridge in multiple pole options are available to solve any power distribution need.

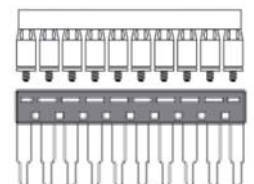

See page 16- 20

Rail Products



An array of rail products are offered to compliment the DIN-Rail Terminal Block product line. Products available include 15mm, 35mm aluminium DIN-Rail; and 35mm G-type DIN-Rail.

See page 20

Marking System and Labels



Open software, PC-based plotter system can print Cooper Bussmann labels as well as most major competitor labels. A decisive advantage. Blank and pre-printed marking labels are available.

See page 21 - 25

Terminal Blocks Overview

Introducing a full range of single-level and two-level feed through screw connection DIN-Rail terminal blocks, test and disconnect blocks, grounding blocks, plug-in and screw-on bridges, marking system and accessories. High quality and high functionality for all wiring needs.

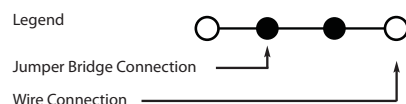
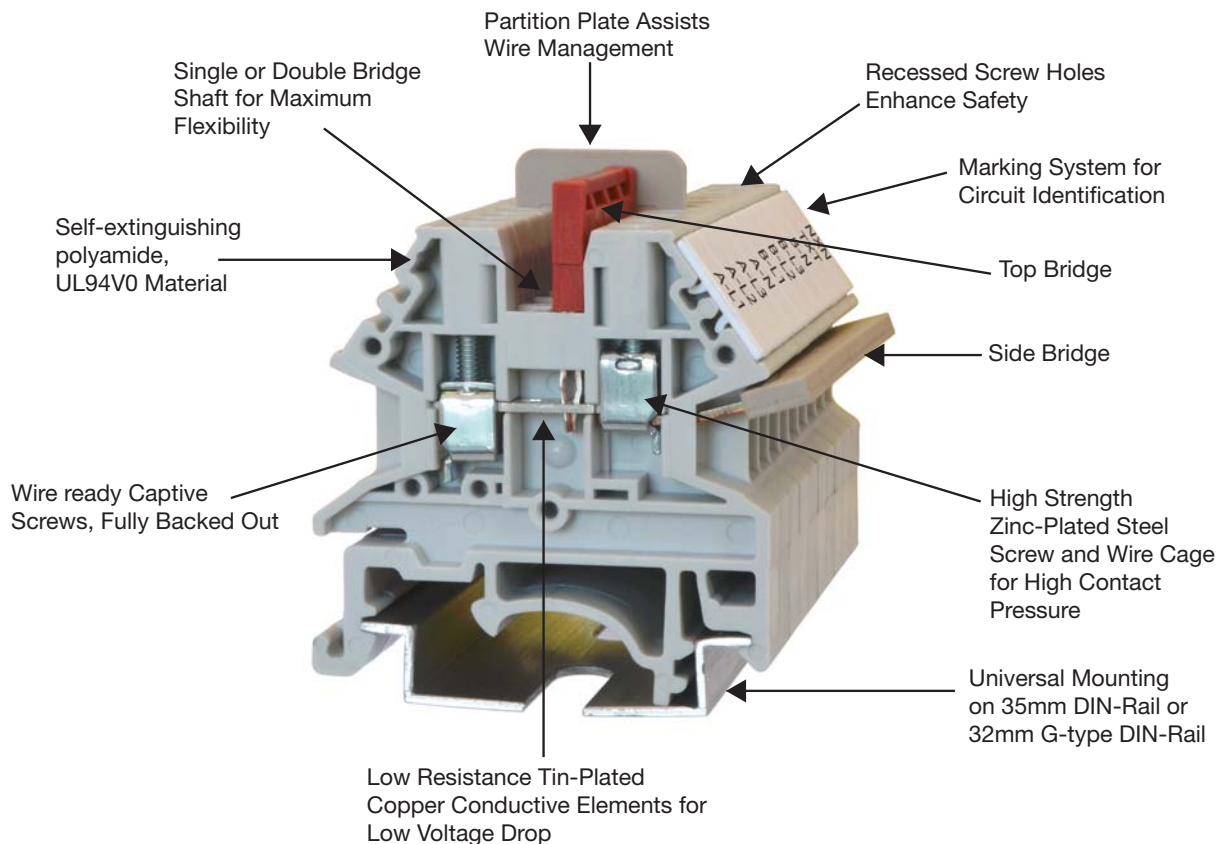

Feed Through Blocks - DP Series

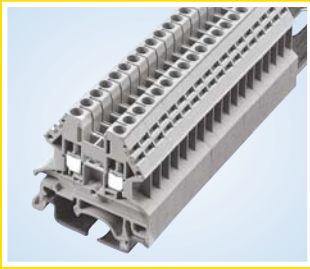

DP Series

The DP Series feature a generous design allowing for more wiring space and access. Additionally, this series feature a larger wire contact area and larger conducting elements. Accessories include marking labels, partition plates, side insertion bridge and top screw-on bridge for improved reliability. Comes with matching shaped grounding blocks. Designed for 35mm DIN and 32mm G-type rails.

IEC 60947-7-1 and UL 1059 compliant.

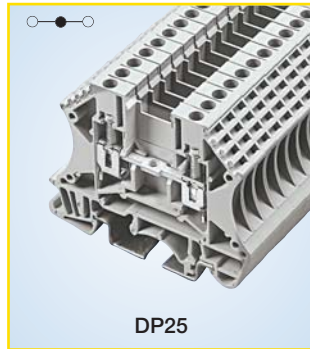

DP25

Approval	CE cRU ^{US}	
Technical Data	UL	IEC
Rated voltage	600V	630V
Rated current	25A	24A
Conductor cross-section, solid (AWG/mm ²)	22~12 / 0.5~2.5	
Conductor cross-section, flexible (AWG/mm ²)	22~12 / 0.5~2.5	
Rated impulse withstand voltage	8kV	
Torque (N•m)	0.8	
Torque (lb-in)	7.1	
Screw	M3	
Wire strip length (mm)	10-12	
W x H x D (mm)	5.1 x 47.6 x 58.9	
Colours	Cat. No	
● Grey	DP25-GY	
● Blue	DP25-BU	
● Black	DP25-LK	
● Red	DP25-RD	
● Yellow	DP25-YW	
● Orange	DP25-OR	
● Green	DP25-GN	
Accessories	Cat. No	
● Grey	DP25-GY-ND	
● Blue	DP25-BU-ND	
● Black	DP25-LK-ND	
● Red	DP25-RD-ND	
● Yellow	DP25-YW-ND	
● Orange	DP25-OR-ND	
● Green	DP25-GN-ND	
	DKSPS-001	
	DKSPS-002	
2-pole	CSC-2-502P	
3-pole	CSC-2-503P	
4-pole	CSC-2-504P	
10-pole	CSC-2-510P	
2-pole	DS2-5-02P	
3-pole	DS2-5-03P	
4-pole	DS2-5-04P	
10-pole	DS2-5-10P	
	TM26CB	
	DRL32MMG DRL35MMHI DRL35MML0	
	0.4 x 2.5mm	

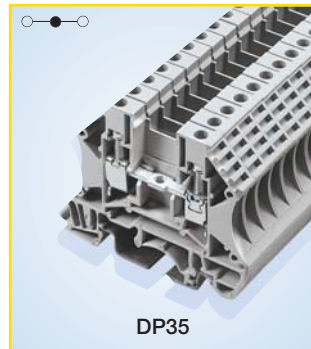

DP35

Approval	CE cRU ^{US}	
Technical Data	UL	IEC
Rated voltage	600V	630V
Rated current	35A	32A
Conductor cross-section, solid (AWG/mm ²)	22~10 / 0.5~4	
Conductor cross-section, flexible (AWG/mm ²)	22~10 / 0.5~4	
Rated impulse withstand voltage	8kV	
Torque (N•m)	0.8	
Torque (lb-in)	7.1	
Screw	M3	
Wire strip length (mm)	10-12	
W x H x D (mm)	6.1 x 47.6 x 58.9	
Colours	Cat. No	
● Grey	DP35-GY	
● Blue	DP35-BU	
● Black	DP35-LK	
● Red	DP35-RD	
● Yellow	DP35-YW	
● Orange	DP35-OR	
● Green	DP35-GN	
Accessories	Cat. No	
● Grey	DP25-GY-ND	
● Blue	DP25-BU-ND	
● Black	DP25-LK-ND	
● Red	DP25-RD-ND	
● Yellow	DP25-YW-ND	
● Orange	DP25-OR-ND	
● Green	DP25-GN-ND	
	DKSPS-001	
	DKSPS-002	
2-pole	CSC-402P	
3-pole	CSC-403P	
4-pole	CSC-404P	
10-pole	CSC-410P	
2-pole	DS4-02P	
3-pole	DS4-03P	
4-pole	DS4-04P	
10-pole	DS4-10P	
	TM27CB	
	DRL32MMG DRL35MMHI DRL35MML0	
	0.5 x 3mm	

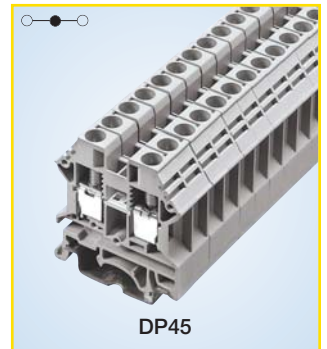

DP45

Approval	CE cRU ^{US}	
Technical Data	UL	IEC
Rated voltage	600V	500V
Rated current	45A	41A
Conductor cross-section, solid (AWG/mm ²)	20~8 / 0.5~6	
Conductor cross-section, flexible (AWG/mm ²)	20~8 / 0.5~6	
Rated impulse withstand voltage	8kV	
Torque (N•m)	1.8	
Torque (lb-in)	15.9	
Screw	M4	
Wire strip length (mm)	12-14	
W x H x D (mm)	8 x 47.6 x 58.9	
Colours	Cat. No	
● Grey	DP45-GY	
● Blue	DP45-BU	
● Black	DP45-LK	
● Red	DP45-RD	
● Yellow	DP45-YW	
● Orange	DP45-OR	
● Green	DP45-GN	
Accessories	Cat. No	
● Grey	DP25-GY-ND	
● Blue	DP25-BU-ND	
● Black	DP25-LK-ND	
● Red	DP25-RD-ND	
● Yellow	DP25-YW-ND	
● Orange	DP25-OR-ND	
● Green	DP25-GN-ND	
	DKSPS-001	
	DKSPS-002	
2-pole	CSC-602P	
3-pole	CSC-603P	
4-pole	CSC-604P	
10-pole	CSC-610P	
2-pole	DS6-02P	
3-pole	DS6-03P	
4-pole	DS6-04P	
10-pole	DS6-10P	
	TM28CB	
	DRL32MMG DRL35MMHI DRL35MML0	
	0.8 x 4mm	

Block



End cover



Partition



Small partition



Side insertion bridge



Top screw-on bridge



Marking label



Mounting rail



Tool



Feed Through Blocks - DP Series

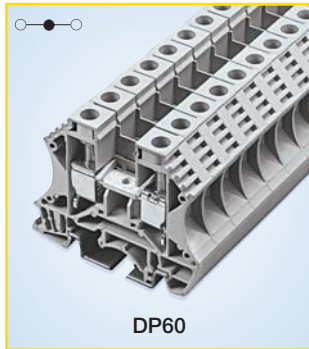

DP60

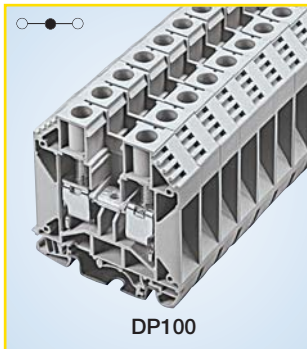

DP100



DP150

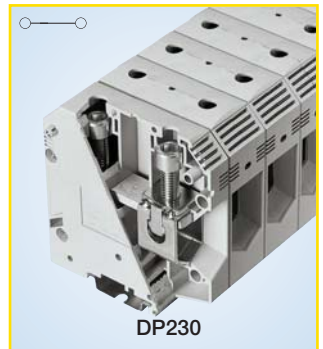

DP230

Approval	CE C RU US	
Technical Data	UL	IEC
Rated voltage	600V	500V
Rated current	60A	57A
Conductor cross-section, solid (AWG/mm ²)	20~6 / 1.5~10	
Conductor cross-section, flexible (AWG/mm ²)	20~6 / 1.5~10	
Rated impulse withstand voltage	8kV	
Torque (N•m)	1.8	
Torque (lb-in)	15.9	
Screw	M4	
Wire strip length (mm)	12-14	
W x H x D (mm)	10 x 47.6 x 58.9	
Colours	Cat. No	
● Grey	DP60-GY	
Accessories	Cat. No	
● Grey	DP25-GY-ND	
	DKSPS-001	
	DKSPS-002	
2-pole	CSC-1002P	
3-pole	CSC-1003P	
4-pole	CSC-1004P	
10-pole	CSC-1010P	
2-pole	DS10-02P	
3-pole	DS10-03P	
4-pole	DS10-04P	
10-pole	DS10-10P	
	TM28CB	
	DRL32MMG DRL35MMHI DRL35MML0	
	0.8 x 4mm	

Approval	CE C RU US	
Technical Data	UL	IEC
Rated voltage	600V	1000V
Rated current	100A	101A
Conductor cross-section, solid (AWG/mm ²)	14~3 / 1.5~25	
Conductor cross-section, flexible (AWG/mm ²)	14~3 / 1.5~25	
Rated impulse withstand voltage	8kV	
Torque (N•m)	3.4	
Torque (lb-in)	30.1	
Screw	M5	
Wire strip length (mm)	13-15	
W x H x D (mm)	12 x 52.2 x 46.7	
Colours	Cat. No	
● Grey	DP100-GY	
Accessories	Cat. No	
● Grey	DP100-GY-ND	
	DKNSPS-003	
2-pole	CSC-1602P	
3-pole	CSC-1603P	
4-pole	CSC-1604P	
10-pole	CSC-1610P	
2-pole	DS16-02P	
3-pole	DS16-03P	
4-pole	DS16-04P	
10-pole	DS16-10P	
	TM28CB	
	DRL32MMG DRL35MMHI DRL35MML0	
	1 x 5.5mm	

Approval	CE C RU US	
Technical Data	UL	IEC
Rated voltage	600V	1000V
Rated current	150A	150A
Conductor cross-section, solid (AWG/mm ²)	12~1 / 2.5~50	
Conductor cross-section, flexible (AWG/mm ²)	12~1/0 / 2.5~50	
Rated impulse withstand voltage	8kV	
Torque (N•m)	6.9	
Torque (lb-in)	61.1	
Screw	M6	
Wire strip length (mm)	16-18	
W x H x D (mm)	16 x 61.2 x 52	
Colours	Cat. No	
● Grey	DP150-GY	
● Blue	DP150-BU	
Accessories	Cat. No	
	DKNSPS-004	
2-pole	CSC-3502P	
3-pole	CSC-3503P	
4-pole	CSC-3504P	
10-pole	CSC-3510P	
2-pole	DS35-02P	
3-pole	DS35-03P	
4-pole	DS35-04P	
10-pole	DS35-10P	
	TM28CB	
	DRL32MMG DRL35MMHI DRL35MML0	
	1 x 5.5mm	

Approval	CE C RU US	
Technical Data	UL	IEC
Rated voltage	600V	1000V
Rated current	230A	232A
Conductor cross-section, solid (AWG/mm ²)	2 / 35	
Conductor cross-section, flexible (AWG/mm ²)	2~4/0 / 35-95	
Rated impulse withstand voltage	8kV	
Torque (N•m)	10.2	
Torque (lb-in)	90.3	
Screw	M8	
Wire strip length (mm)	30-35	
W x H x D (mm)	25 x 88.5 x 80	
Colours	Cat. No	
● Grey	DP230-GY	
● Blue	DP230-BU	
Accessories	Cat. No	
	DKNSPS-004	
2-pole	CSC-9502P	
3-pole	CSC-9503P	
4-pole	N/A	
10-pole	N/A	
2-pole	N/A	
3-pole	N/A	
4-pole	N/A	
10-pole	N/A	
	TM28CB	
	DRL32MMG DRL35MMHI DRL35MML0	
	1 x 5.5mm	



Feed Through Blocks - DS Series

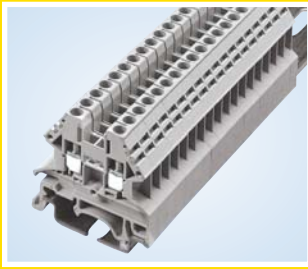

DS Series

The DS Series feature a compact design that save wiring space on the control panels. Accessories include marking labels, partition plates as well as side and top insertion bridges. Designed for 35mm DIN and 32mm G-type rails.

IEC 60947-7-1 and UL 1059 compliant



DS20



DS30

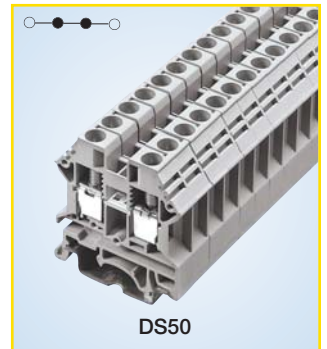

DS50

Approval	CE	C	RU	US
Technical Data	UL	IEC		
Rated voltage	600V	1000V		
Rated current	20A	24A		
Conductor cross-section, solid (AWG/mm ²)	22~12 / 0.5~2.5			
Conductor cross-section, flexible (AWG/mm ²)	22~12 / 0.5~2.5			
Rated impulse withstand voltage	6kV			
Torque (N•m)	0.4			
Torque (lb-in)	3.5			
Screw	M2.5			
Wire strip length (mm)	9~11			
W x H x D (mm)	5.1 x 39.6 x 40.5			
Colours	Cat. No			
● Grey	DS20-GY			
● Blue	DS20-BU			
● Black	DS20-LK			
● Red	DS20-RD			
● Yellow	DS20-YW			
● Orange	DS20-OR			
● Green	DS20-GN			
Accessories	Cat. No			
● Grey	DS20-GY-ND			
● Blue	DS20-BU-ND			
● Black	DS20-LK-ND			
● Red	DS20-RD-ND			
● Yellow	DS20-YW-ND			
● Orange	DS20-OR-ND			
● Green	DS20-GN-ND			
	DKNSPS-001			
2-pole	DSS2-5N-02P			
3-pole	DSS2-5N-03P			
4-pole	DSS2-5N-04P			
10-pole	DSS2-5N-10P			
2-pole	CSC-2-502PN			
3-pole	CSC-2-503PN			
4-pole	CSC-2-504PN			
10-pole	CSC-2-510PN			
	TM26CB			
	DRL32MMG			
	DRL35MMHI			
	DRL35MML0			
	+			

Approval	CE	C	RU	US
Technical Data	UL	IEC		
Rated voltage	600V	1000V		
Rated current	30A	32A		
Conductor cross-section, solid (AWG/mm ²)	22~10 / 0.5~4			
Conductor cross-section, flexible (AWG/mm ²)	22~10 / 0.5~4			
Rated impulse withstand voltage	6kV			
Torque (N•m)	0.6			
Torque (lb-in)	5.3			
Screw	M3			
Wire strip length (mm)	9~11			
W x H x D (mm)	6.1 x 39.6 x 40.3			
Colours	Cat. No			
● Grey	DS30-GY			
● Blue	DS30-BU			
● Black	DS30-LK			
● Red	DS30-RD			
● Yellow	DS30-YW			
● Orange	DS30-OR			
● Green	DS30-GN			
Accessories	Cat. No			
● Grey	DS30-GY-ND			
● Blue	DS30-BU-ND			
● Black	DS30-LK-ND			
● Red	DS30-RD-ND			
● Yellow	DS30-YW-ND			
● Orange	DS30-OR-ND			
● Green	DS30-GN-ND			
	DKNSPS-001			
2-pole	DSS4N-02P			
3-pole	DSS4N-03P			
4-pole	DSS4N-04P			
10-pole	DSS4N-10P			
2-pole	CSC-402PN			
3-pole	CSC-403PN			
4-pole	CSC-404PN			
10-pole	CSC-410PN			
	TM27CB			
	DRL32MMG			
	DRL35MMHI			
	DRL35MML0			
	+			

Approval	CE	C	RU	US
Technical Data	UL	IEC		
Rated voltage	600V	1000V		
Rated current	50A	41A		
Conductor cross-section, solid (AWG/mm ²)	22~10 / 0.5~4			
Conductor cross-section, flexible (AWG/mm ²)	20~8 / 0.5~6			
Rated impulse withstand voltage	8kV			
Torque (N•m)	1.2			
Torque (lb-in)	10.6			
Screw	M4			
Wire strip length (mm)	12~14			
W x H x D (mm)	8 x 45 x 41.7			
Colours	Cat. No			
● Grey	DS50-GY			
● Blue	DS50-BU			
● Black	DS50-LK			
● Red	DS50-RD			
● Yellow	DS50-YW			
● Orange	DS50-OR			
● Green	DS50-GN			
Accessories	Cat. No			
● Grey	DS50-GY-ND			
● Blue	DS50-BU-ND			
● Black	DS50-LK-ND			
● Red	DS50-RD-ND			
● Yellow	DS50-YW-ND			
● Orange	DS50-OR-ND			
● Green	DS50-GN-ND			
	DKNSPS-002			
2-pole	DSS6N-02P			
3-pole	DSS6N-03P			
4-pole	DSS6N-04P			
10-pole	DSS6N-10P			
2-pole	CSC-602PN			
3-pole	CSC-603PN			
4-pole	CSC-604PN			
10-pole	CSC-610PN			
	TM28CB			
	DRL32MMG			
	DRL35MMHI			
	DRL35MML0			
	+			

Block



End cover



Small partition



Top insertion bridge



Side insertion bridge



Marking label



Mounting rail



Tool



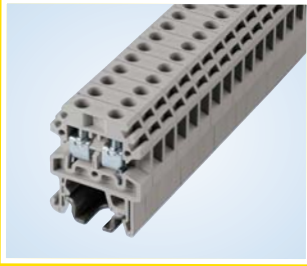

DM Series

The DM Series is our low cost, miniature feed through terminal block design for 15mm DIN-Rail. Accessories include side insertion bridge and marking labels.



Approval		
	CE	C ^{RU} US
Technical Data	UL	IEC
Rated voltage	300V	500V
Rated current	20A	24A
Conductor cross-section, solid (AWG/mm ²)	22~12 / 0.5~2.5	
Conductor cross-section, flexible (AWG/mm ²)	22~12 / 0.5~2.5	
Rated impulse withstand voltage	5kV	
Torque (N•m)	0.4	
Torque (lb-in)	3.5	
Screw	M2.5	
Wire strip length (mm)	7~9	
W x H x D (mm)	5.1 x 28 x 22	
Colours	Cat. No	
● Grey	DM20-GY	
● Blue	DM20-BU	
● Black	DM20-LK	
Accessories	Cat. No	
● Grey	DM20-GY-ND	
● Blue	DM20-BU-ND	
● Black	DM20-LK-ND	
2-pole	CSC-2-502PS	
3-pole	CSC-2-503PS	
4-pole	CSC-2-504PS	
10-pole	CSC-2-510PS	
	TM20CB	
	DRL15MM	

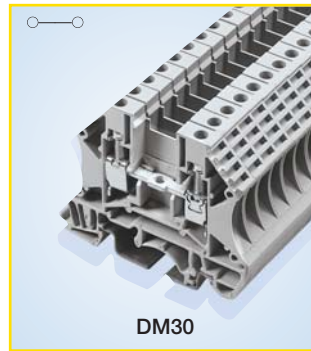

Approval		
	CE	C ^{RU} US
Technical Data	UL	IEC
Rated voltage	300V	500V
Rated current	30A	32A
Conductor cross-section, solid (AWG/mm ²)	22~10 / 0.5~4	
Conductor cross-section, flexible (AWG/mm ²)	22~10 / 0.5~4	
Rated impulse withstand voltage	5kV	
Torque (N•m)	0.6	
Torque (lb-in)	5.3	
Screw	M3	
Wire strip length (mm)	7~9	
W x H x D (mm)	6.1 x 31.5 x 22	
Colours	Cat. No	
● Grey	DM30-GY	
● Blue	DM30-BU	
● Black	DM30-LK	
Accessories	Cat. No	
● Grey	DM30-GY-ND	
● Blue	DM30-BU-ND	
● Black	DM30-LK-ND	
2-pole	CSC-402PS	
3-pole	CSC-403PS	
4-pole	CSC-404PS	
10-pole	CSC-410PS	
	TM21CB	
	DRL15MM	

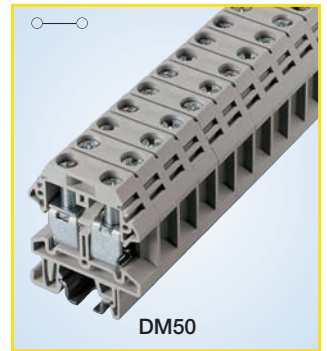

Approval		
	CE	C ^{RU} US
Technical Data	UL	IEC
Rated voltage	300V	500V
Rated current	50A	41A
Conductor cross-section, solid (AWG/mm ²)	20~8 / 0.5~6	
Conductor cross-section, flexible (AWG/mm ²)	20~8 / 0.5~6	
Rated impulse withstand voltage	6kV	
Torque (N•m)	1.2	
Torque (lb-in)	10.6	
Screw	M4	
Wire strip length (mm)	9~11	
W x H x D (mm)	8 x 37.4 x 30	
Colours	Cat. No	
● Grey	DM50-GY	
● Blue	DM50-BU	
● Black	DM50-LK	
Accessories	Cat. No	
● Grey	DM50-GY-ND	
● Blue	DM50-BU-ND	
● Black	DM50-LK-ND	
2-pole	CSC-602PS	
3-pole	CSC-603PS	
4-pole	CSC-604PS	
10-pole	CSC-610PS	
	TM22CB	
	DRL15MM	

Block



End Cover



Side Insertion Bridge



Marking Label



Mounting Rail



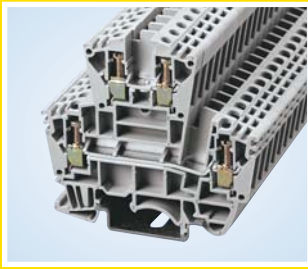

DDP Series

The DDP30 is a two-tier feed through terminal block for space constrained applications with two independent circuits (IEC 60947-7 and UL 1059 compliant). Marking system, side insertion bridge and top screw-on bridge are standard.

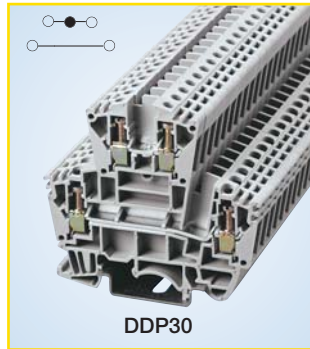

DDP30

Approval		
	CE	UL US
Technical Data		
Rated voltage	300V	400V
Rated current	30A	32A
Conductor cross-section, solid (AWG/mm ²)	22~10 / 0.5~4	
Conductor cross-section, flexible (AWG/mm ²)	22~10 / 0.5~4	
Rated impulse withstand voltage	6kV	
Torque (N•m)	0.5	
Torque (lb-in)	4.4	
Screw	M2.5	
Wire strip length (mm)	6	
W x H x D (mm)	6.1 x 62.8 x 69.4	
Colours		Cat. No
● Grey		DDP30-GY
Accessories		Cat. No
● Grey		DDP30-GY-ND
2-pole		CSC-402P
3-pole		CSC-403P
4-pole		CSC-404P
10-pole		CSC-410P
2-pole		DS4-02P
3-pole		DS4-03P
4-pole		DS4-04P
10-pole		DS4-10P
		TM21CB
		DRL32MMG DRL35MMHI DRL35MML0
		0.4 x 2.5mm

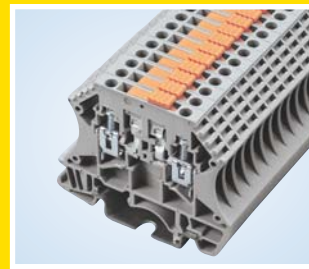
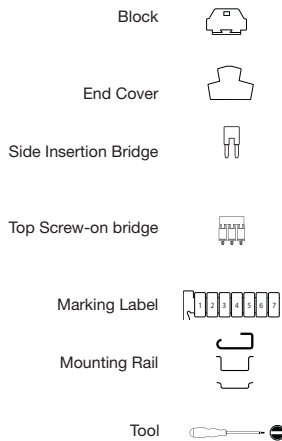

DIS Series

The DIS10 is a disconnect* terminal block. Disconnect terminal blocks offer easy circuit disconnection with just a flick of a screwdriver. IEC 60947-7 and UL 1059 compliant.

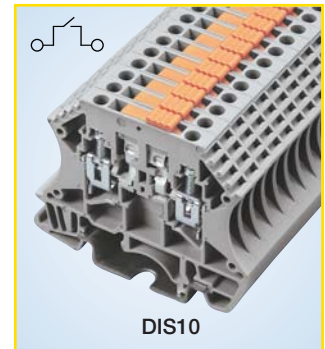

DIS10

Approval		
	CE	UL US
Technical Data		
Rated voltage	300V	800V
Rated current	10A	16A
Conductor cross-section, solid (AWG/mm ²)	26~14 / 0.5~2.5	
Conductor cross-section, flexible (AWG/mm ²)	26~14 / 0.5~2.5	
Rated impulse withstand voltage	6kV	
Torque (N•m)	0.8	
Torque (lb-in)	7.1	
Screw	M3	
Wire strip length (mm)	9~10	
W x H x D (mm)	5.1 x 46.7 x 59	
Colours		Cat. No
● Grey		DIS10-GY
Accessories		Cat. No
● Grey		DP25-GY-ND
		DKSPS-002
2-pole		CSC-2-502P
3-pole		CSC-2-503P
4-pole		CSC-2-504P
10-pole		CSC-2-510P
		TM26CB
		DRL32MMG DRL35MMHI DRL35MML0
		0.5 x 3mm

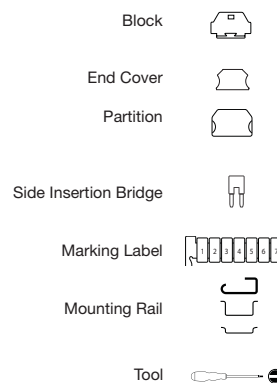

* Not for use as a load break disconnect.

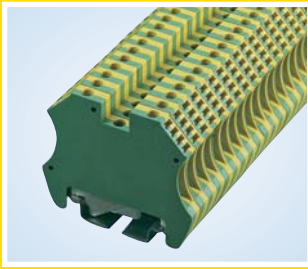

DG Series

The DG Series grounding DIN-Rail Terminal blocks fit both standard 35mm DIN-Rail and 32mm G-Type rails. Compliant with IEC 60947-7 and UL 1059 standards for worldwide acceptance. These have the same general shape as the DP Series.

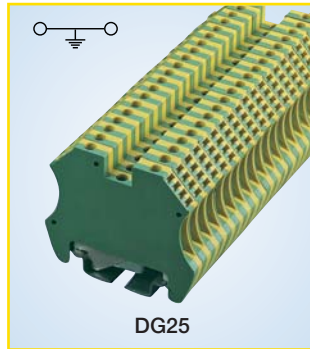

Approval	CE C _{RU} US	
Technical Data	UL	IEC
Rated voltage	600V	630V
Rated current	24A	
Conductor cross-section, solid (AWG/mm ²)	26~12 / 0.5~2.5	
Conductor cross-section, flexible (AWG/mm ²)	26~12 / 0.5~2.5	
Rated impulse withstand voltage	8kV	
Torque (N•m)	0.8	
Torque (lb-in)	7.1	
Screw	M3	
Wire strip length (mm)	10~14	
W x H x D (mm)	5.7 x 46.4 x 56	
Colours	Cat. No	
● Yellow/Green	DG25-YG	
Accessories	Cat. No	
	TM26CB	
	DRL32MMG DRL35MMHI DRL35MML0	
	0.5 x 3mm	

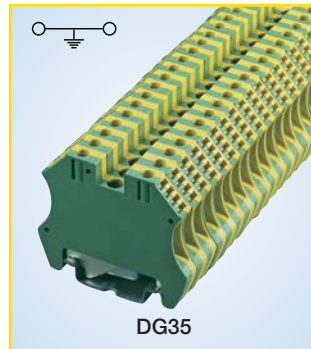

Approval	CE C _{RU} US	
Technical Data	UL	IEC
Rated voltage	600V	630V
Rated current	32A	
Conductor cross-section, solid (AWG/mm ²)	26~10 / 0.5~4	
Conductor cross-section, flexible (AWG/mm ²)	26~10 / 0.5~4	
Rated impulse withstand voltage	8kV	
Torque (N•m)	0.8	
Torque (lb-in)	7.1	
Screw	M3	
Wire strip length (mm)	12~16	
W x H x D (mm)	6.6 x 46.4 x 56	
Colours	Cat. No	
● Yellow/Green	DG35-YG	
Accessories	Cat. No	
	TM27CB	
	DRL32MMG DRL35MMHI DRL35MML0	
	0.5 x 3mm	

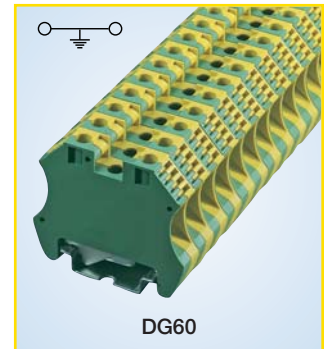

Approval	CE C _{RU} US	
Technical Data	UL	IEC
Rated voltage	600V	500V
Rated current	57A	
Conductor cross-section, solid (AWG/mm ²)	16~8 / 1.5~10	
Conductor cross-section, flexible (AWG/mm ²)	16~8 / 1.5~10	
Rated impulse withstand voltage	8kV	
Torque (N•m)	1.8	
Torque (lb-in)	15.9	
Screw	M4	
Wire strip length (mm)	12~16	
W x H x D (mm)	10.4 x 46.4 x 56	
Colours	Cat. No	
● Yellow/Green	DG60-YG	
Accessories	Cat. No	
	TM28CB	
	DRL32MMG DRL35MMHI DRL35MML0	
	0.8 x 4mm	

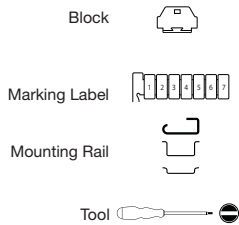

Grounding Blocks - DG Series

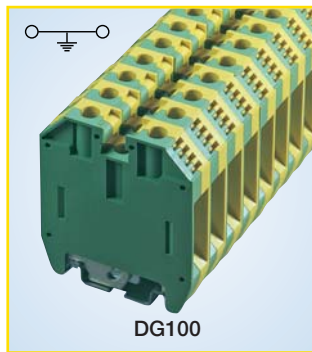

DG100

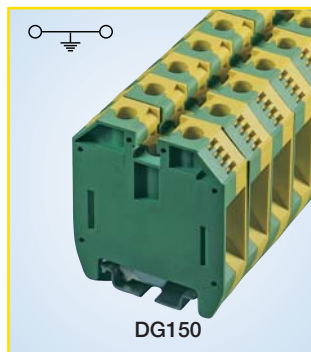

DG150

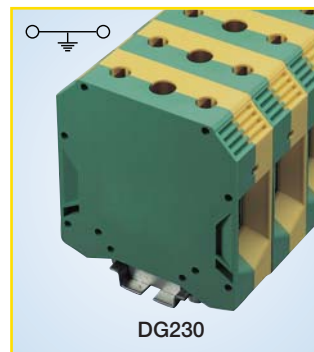

DG230

Approval	CE cRU [®] US	
Technical Data	UL	IEC
Rated voltage	600V	1000V
Rated current	76A	
Conductor cross-section, solid (AWG/mm ²)	14~6 / 2.5~16	
Conductor cross-section, flexible (AWG/mm ²)	14~6 / 2.5~16	
Rated impulse withstand voltage	8kV	
Torque (N•m)	3.4	
Torque (lb-in)	30.1	
Screw	M5	
Wire strip length (mm)	14~18	
W x H x D (mm)	12 x 62.4 x 56	
Colours	Cat. No	
● Yellow/Green	DG100-YG	
Accessories	Cat. No	
	TM28CB	
	DRL32MMG DRL35MMHI DRL35MML0	
	1 x 5.5mm	

Approval	CE cRU [®] US	
Technical Data	UL	IEC
Rated voltage	600V	1000V
Rated current	125A	
Conductor cross-section, solid (AWG/mm ²)	12~2 / 4~35	
Conductor cross-section, flexible (AWG/mm ²)	12~2 / 4~35	
Rated impulse withstand voltage	8kV	
Torque (N•m)	5.6	
Torque (lb-in)	49.6	
Screw	M6	
Wire strip length (mm)	14~18	
W x H x D (mm)	16 x 62.4 x 56	
Colours	Cat. No	
● Yellow/Green	DG150-YG	
Accessories	Cat. No	
	TM28CB	
	DRL32MMG DRL35MMHI DRL35MML0	
	1 x 5.5mm	

Approval	CE cRU [®] US	
Technical Data	UL	IEC
Rated voltage	600V	1000V
Rated current	232A	
Conductor cross-section, solid (AWG/mm ²)	2 / 35	
Conductor cross-section, flexible (AWG/mm ²)	2~4/0 / 35~95	
Rated impulse withstand voltage	8kV	
Torque (N•m)	18	
Torque (lb-in)	159.3	
Screw	M8	
Wire strip length (mm)	20~25	
W x H x D (mm)	25 x 82.93 x 80	
Colours	Cat. No	
● Yellow/Green	DG230-YG	
Accessories	Cat. No	
	TM28CB	
	DRL32MMG DRL35MMHI DRL35MML0	
	1 x 5.5mm	

Block



Marking Label



Mounting Rail



Tool



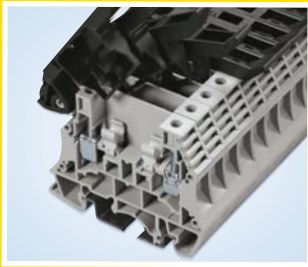

F520 Series

Fuse terminal blocks protect your sensors and relays. Available in lever and screw-cap style, with and without LED indication. Uses standard Cooper Bussmann 5x20mm fuse links.

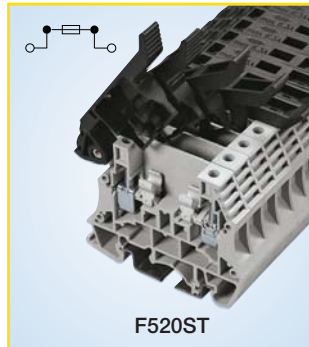

F520ST

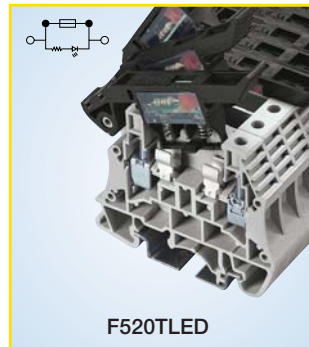

F520TLED

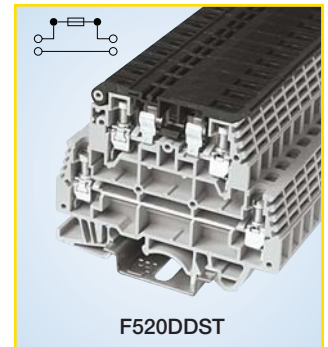

F520DDST

Approval	CE	C	RU	US
Technical Data	UL	IEC		
Rated voltage	300V	300V		
Rated current	6.3A	6.3A		
Conductor cross-section, solid (AWG/mm ²)	24~12 / 0.5~4			
Conductor cross-section, flexible (AWG/mm ²)	24~12 / 0.5~4			
Rated impulse withstand voltage	6kV			
Torque (N•m)	0.8			
Torque (lb-in)	7.1			
Screw	M3			
Wire strip length (mm)	10-12			
W x H x D (mm)	8 x 55.7 x 56			

Colours	Cat. No
● Grey	F520ST-GY

Accessories	Cat. No
● Grey End Cover	F520-GY-ND
2-pole	CSC-602PN
3-pole	CSC-603PN
4-pole	CSC-604PN
10-pole	CSC-610PN
	TM28CB
	DRL32MMG
	DRL35MMHI
	DRL35MML0
	0.5 x 3mm

Approval	CE	C	RU	US
Technical Data	UL	IEC		
Rated voltage	300V	300V		
Rated current	6.3A	6.3A		
Conductor cross-section, solid (AWG/mm ²)	24~12 / 0.5~4			
Conductor cross-section, flexible (AWG/mm ²)	24~12 / 0.5~4			
Rated impulse withstand voltage	6kV			
Torque (N•m)	0.8			
Torque (lb-in)	7.1			
Screw	M3			
Wire strip length (mm)	10-12			
W x H x D (mm)	8 x 55.7 x 56			

Colours	Voltage	Cat. No
● Grey	5V	F520STLED5-GY
● Grey	12V	F520STLED12-GY
● Grey	24V	F520STLED24-GY
● Grey	48V	F520STLED48-GY
● Grey	110V	F520STLED110-GY
● Grey	220V	F520STLED220-GY
● Grey	300V	F520STLED300-GY

Accessories	Cat. No
● Grey End Cover	F520-GY-ND
2-pole	CSC-602PN
3-pole	CSC-603PN
4-pole	CSC-604PN
10-pole	CSC-610PN
	TM28CB
	DRL32MMG
	DRL35MMHI
	DRL35MML0
	0.5 x 3mm

Approval	CE	C	RU	US
Technical Data	UL	IEC		
Rated voltage	300V ⁽¹⁾	300V		
Rated current	16A ⁽²⁾	16A ⁽²⁾	30A ⁽³⁾	30A ⁽³⁾
Conductor cross-section, solid (AWG/mm ²)	22~10 / 0.5~4			
Conductor cross-section, flexible (AWG/mm ²)	22~10 / 0.5~4			
Rated impulse withstand voltage	6kV			
Torque (N•m)	0.67			
Torque (lb-in)	5.9			
Screw	M3.5			
Wire strip length (mm)	10-12			
W x H x D (mm)	8 x 60.5 x 72.5			

Colours	Cat. No
● Grey	F520DDST-GY

Accessories	Cat. No
● Grey	F520DD-GY-ND
	TM28CB
	DRL32MMG
	DRL35MMHI
	DRL35MML0
	0.5 x 3mm

Block



End Cover



Side Insertion Bridge



Marking Label



Mounting Rail



Tool



1) UL 600V/5A
2) Upper Level
3) Lower Level

Fuse Holder Blocks - F520 Series Internally Jumpered Blocks

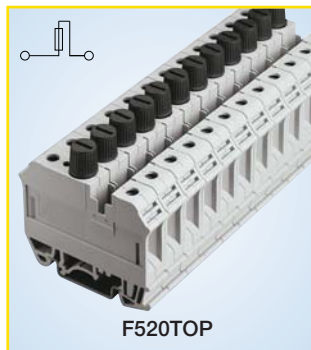

F520TOP

Approval	CE cRU [®] us	
Technical Data	UL	IEC
Rated voltage	600V	660V
Rated current	6.3A	6.3A
Conductor cross-section, solid (AWG/mm ²)	22~6 / 1.5~10	
Conductor cross-section, flexible (AWG/mm ²)	22~6 / 1.5~10	
Rated impulse withstand voltage	6kV	
Torque (N•m)	1.8	
Torque (lb-in)	15.9	
Screw	M4	
Wire strip length (mm)	12~16	
W x H x D (mm)	12 x 47.2 x 61.6	
Colours	Cat. No	
● Grey	F520TOP-GY	
Accessories	Cat. No	
	TM20CB	
	DRL32MMG DRL35MMHI DRL35MML0	
	0.6 x 3.5mm	

Block



Marking Label



Mounting Rail



Tool

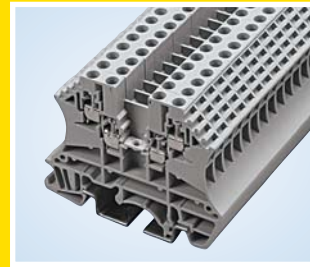
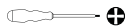

DDNS Series

The DDNS10 is an internally jumpered terminal block. Internally jumpered double-level terminal blocks provide high-density power distribution in 3-in/1-out or 2-in/2-out or 1-in/3-out options with a single block. Add top and side insertion bridges to achieve any connection topology. IEC 60947-7 and UL 1059 compliant.

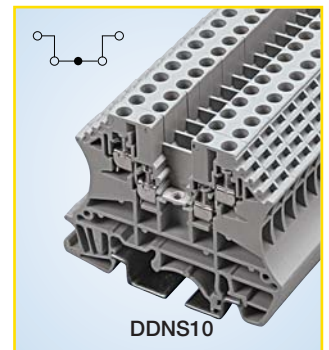

DDNS10

Approval	CE cRU [®] us	
Technical Data	UL	IEC
Rated voltage	300V	630V
Rated current	10A	17.5A
Conductor cross-section, solid (AWG/mm ²)	22~14 / 0.5~1.5	
Conductor cross-section, flexible (AWG/mm ²)	22~14 / 0.5~1.5	
Rated impulse withstand voltage	8kV	
Torque (N•m)	0.4	
Torque (lb-in)	3.5	
Screw	M2.5	
Wire strip length (mm)	6~7	
W x H x D (mm)	5.1 x 46.8 x 58.9	
Colors	Cat. No	
● Grey	DDNS10-GY	
Accessories	Cat. No	
● Grey	DDNS10-GY-ND	
2-pole	CSC-2-502P	
3-pole	CSC-2-503P	
4-pole	CSC-2-504P	
10-pole	CSC-2-510P	
2-pole	DS2-5-02P	
3-pole	DS2-5-03P	
4-pole	DS2-5-04P	
10-pole	DS2-5-10P	
	TM26CB	
	DRL32MMG DRL35MMHI DRL35MML0	
	0.4 x 2.5mm	

Block



End Cover



Side Insertion Bridge



Top Screw-on bridge



Marking Label



Mounting Rail



Tool





DTST2 Series

Test Terminal Blocks

Test terminal blocks with convenient test sockets, plugs, jumpers and accessories to make your circuit troubleshooting easy.

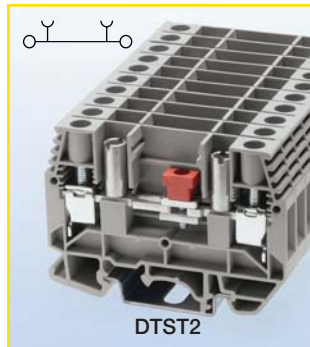

Approval		CE	C	UL	US
Technical Data		UL	IEC		
Rated voltage		300/600V	660V		
Rated current		48A/5A	41A		
Conductor cross-section, solid (AWG/mm ²)		20~8 / 0.5~6			
Conductor cross-section, flexible (AWG/mm ²)		20~8 / 0.5~6			
Rated impulse withstand voltage		6kV			
Torque (N•m)		2			
Torque (lb-in)		17.7			
Screw		M4			
Wire strip length (mm)		8			
W x H x D (mm)		8 x 65.6 x 47.5			
Colors		Cat. No			
● Grey		DTST2-GY			
Accessories					
● Grey		DTST-GY-ND			
		DKSPS-006			
		2-pole DS6A02			
		3-pole DS6A03			
		C002-0101-BK			
		C002-0101-RD			
		DS6S1-BK			
		DS6S1-OR			
		DS6S1-YW			
		DS6S1-RD			
		C002-0201			
		C002-0301			
		2-pole CSC-602P			
		3-pole CSC-603P			
		4-pole CSC-604P			
		10-pole CSC-610P			
		2-pole DS6-02P			
		3-pole DS6-03P			
		4-pole DS6-04P			
		10-pole DS6-10P			
		TM28CB			
		DRL32MMG			
		DRL35MMHI			
		DRL35MML0			
		0.6 x 3.5mm			

- Block
- Partition
- Jumper Slide
- Test Plug
- Screw
- Connection Sleeve
- Connection Socket
- Side insertion bridge
- Top screw-on bridge
- Marking Label
- Mounting Rail
- Tool



Top Screw-On Bridges

DS2-5-XXP

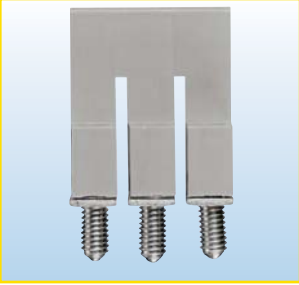

Use with DP25 DG25
DDNS10

Poles (XX) 02,03,04,10

Dimensions - mm

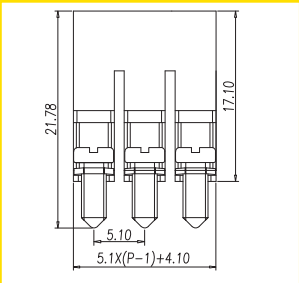

DS4-XXP

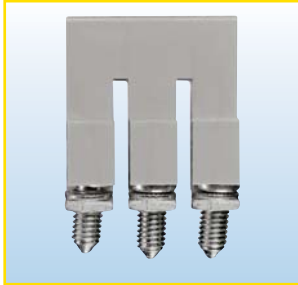

Use with DP35 DDP30

Poles (XX) 02,03,04,10

Dimensions - mm

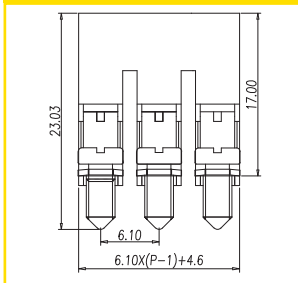

DS6-XXP



Use with DP45 DTST2

Poles (XX) 02,03,04,10

Dimensions - mm

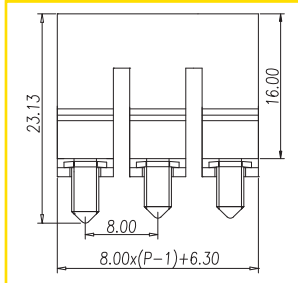

DS10-XXP

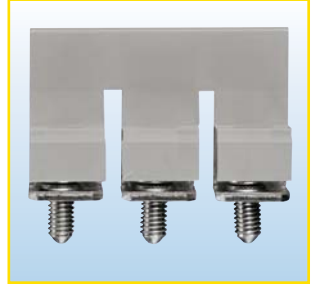

Use with DP60

Poles (XX) 02,03,04,10

Dimensions - mm

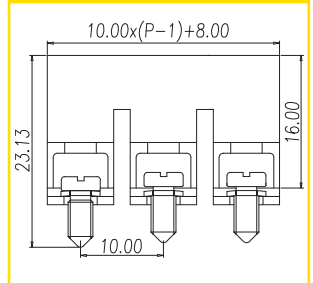

DS16-XXP



Use with DP100

Poles (XX) 02,03,04,10

Dimensions - mm

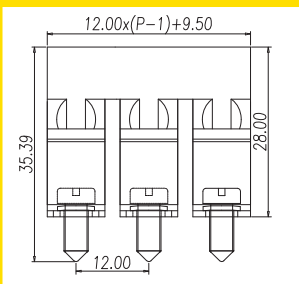

DS35-XXP



Use with DP150

Poles (XX) 02,03,04,10

Dimensions - mm

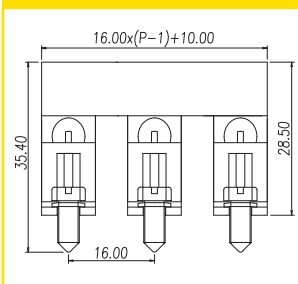

End Brackets

BRKT-ND



Use with DRL35MMHI
DRL35MML0

BRKT-NDSCRW



Use with DRL35MMHI
DRL35MML0

Torque (N•m)	0.5
Torque (lb-in)	4.4
Screw	M3

BRKT-NDSCRW2



Use with DRL35MMHI
DRL35MML0

Torque (N•m)	0.78
Torque (lb-in)	6.9
Screw	M3

BRKT-NDSCRW3

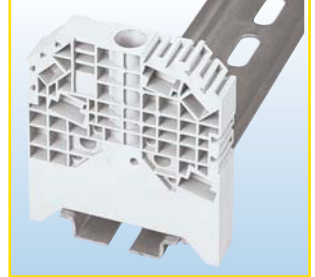

Use with DRL35MMHI
DRL35MML0

Torque (N•m)	1.8
Torque (lb-in)	15.9
Screw	M4

Dimensions - mm

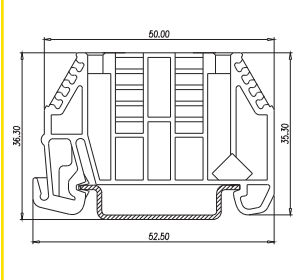

Dimensions - mm

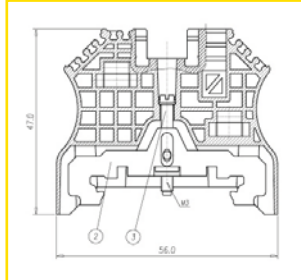

Dimensions - mm

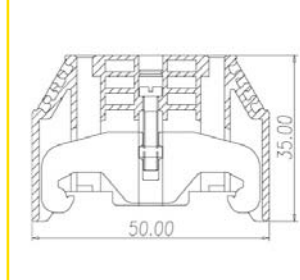

Dimensions - mm

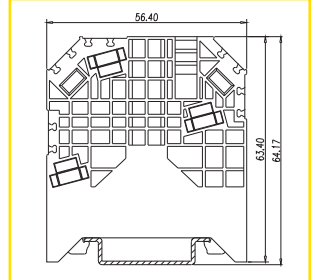

Partition Plates

DKSPS-001



Use with DP25 DP35
DP45 DP60

DKSPS-002



Use with DP25 DP35
DP45 DP60
DIS10

DKSPS-006



Use with DTST2

DKNSPS-001



Use with DS20 DS30

DKNSPS-002



Use with DS50

DKNSPS-003



Use with DP100

DKNSPS-004



Use with DP150

Accessories

Jumper Slides

DS6A02



Use with DTST2

Poles 02

Dimensions - mm

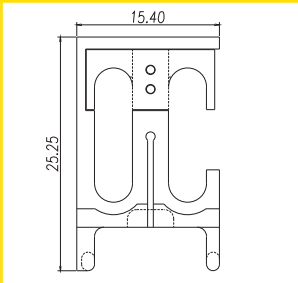

DS6A03

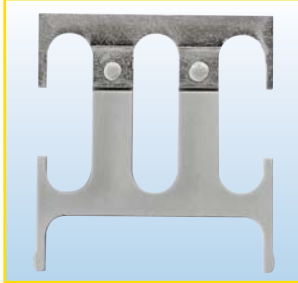

Use with DTST2

Poles 03

Dimensions - mm

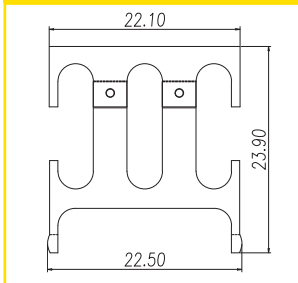

Top Insertion Bridges

DSS2-5N-XXP



Use with DS20

Poles (XX) 02,03,04,10

Dimensions - mm

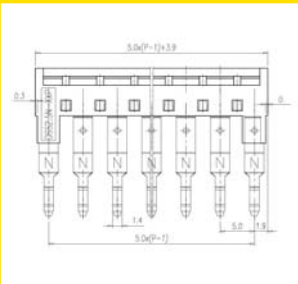

DSS4N-XXP



Use with DS30

Poles (XX) 02,03,04,10

Dimensions - mm

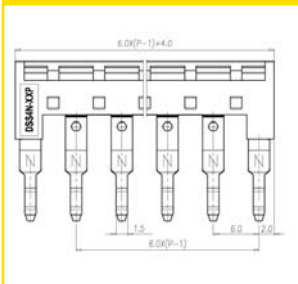

DSS6N-XXP



Use with DS50

Poles (XX) 02,03,04,10

Dimensions - mm

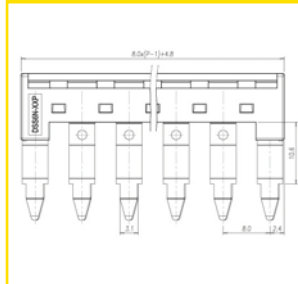

Side Insertion Bridges

CSC-4XXPN

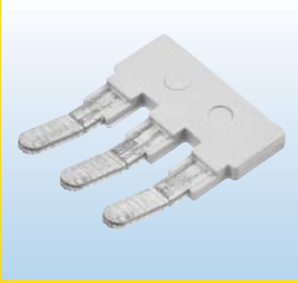

Use with DS30

Poles (XX) 02, 03, 04, 10

Dimensions - mm

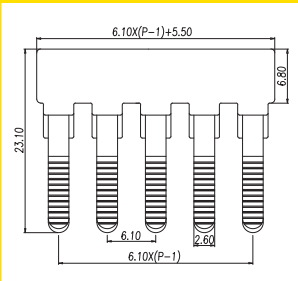

CSC-6XXPN



Use with DS50

Poles (XX) 02, 03, 04, 10

Dimensions - mm

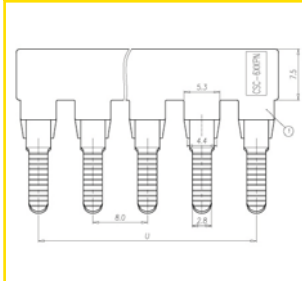

CSC-2-5XXPS

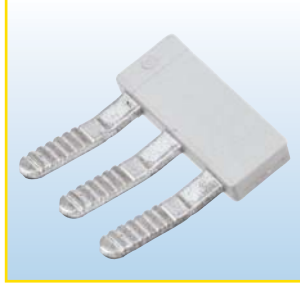

Use with DM20

Poles (XX) 02, 03, 04, 10

Dimensions - mm

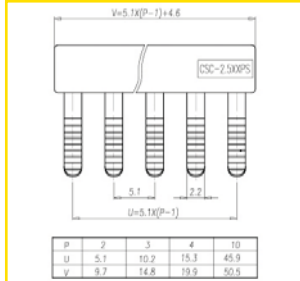

CSC-4XXPS

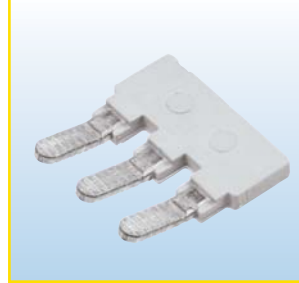

Use with DM30

Poles (XX) 02, 03, 04, 10

Dimensions - mm

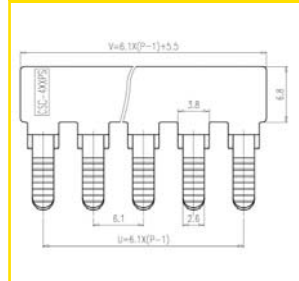

CSC-6XXPS

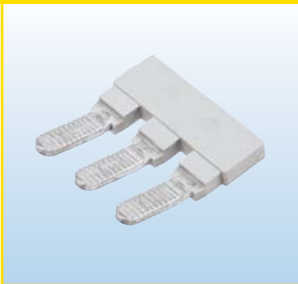

Use with DM50

Poles (XX) 02, 03, 04, 10

Dimensions - mm

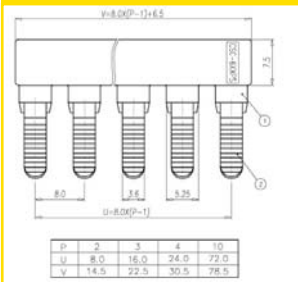

Mounting Rails

DRL15MM*
(15MM DIN-Rail)



DRL32MMG*
(32MM Type G)



DRL35MML0*
(35MM DIN-Rail - Low-Profile)

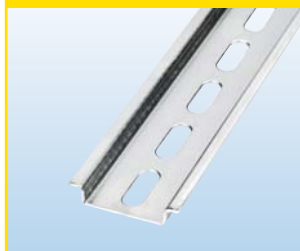

DRL35MMHI*
(35MM DIN-Rail - High Profile)



* Available in 1 Metre lengths only



BussScribe MARKING SYSTEM

DPLT-001SET PLOTTER SET



Description

- Pen is installed manually
- USB interface to PC
- 110-240Vac power supply
- WINDOWS® Operation system

System Kit Includes

- Plotter Pens
- Support Plate
- Software
- Plotter
- Power Supplies
- USB Cable

DPLT-SPLT SUPPORT PLATE

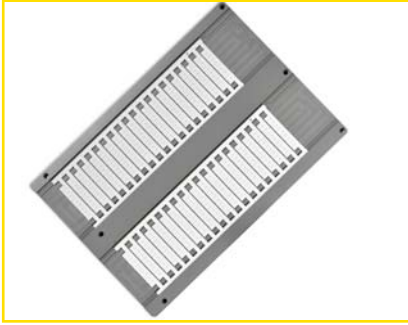

Description

Support plate adjustable to accommodate various sizes of marking labels. The support plate is universal and suitable for TM2xCB marking label series.

Each plotter set includes one support plate, additional plates are available separately.

PLOTTER PEN

DPLT-PEN (Tip 0.25mm) / DPLT-PEN2 (Tip 0.35mm)



Description

Disposable black ink pen.
Single pen per pack.

Marking Label Selection Chart

Part Number	Length (mm)	Width (mm)	Line x Row	Number of Tags	Applicable Block Part Numbers
TM20CB	5.8	5.1	20 x 10	200	F20T0P, DM20
TM21CB	5.8	6.1	20 x 10	200	DDP30, DM30
TM22CB	5.8	8	20 x 8	160	DM50
TM26CB	12	5.1	12 x 12	144	DS20, DP25, DG25, DDNS10, DIS10
TM27CB	12	6.1	12 x 10	120	DS30, DP35, DG35
TM28CB	12	8	12 x 7	84	DS50, DP45, DP60, DP100, DP150, DP230, DG60, DG100, DG150, DG230, F520ST, F520STLED, F520DDST, DTST2

Example: TM20CB-DH01, Horizontal Marking - L1, L2, L3, N, PE

TM20CB Series - mm

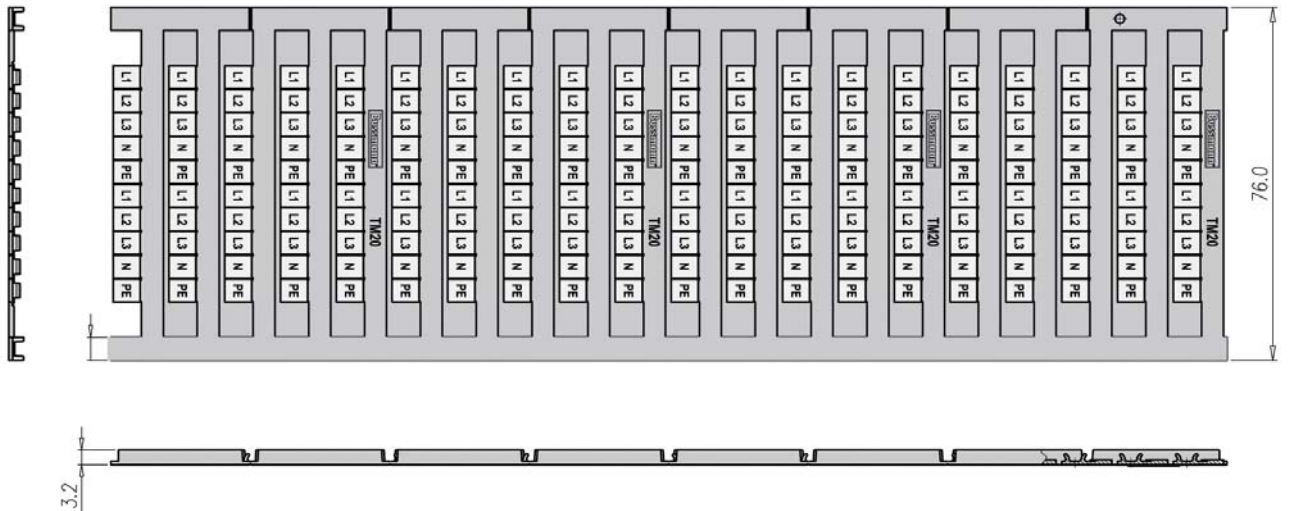

TM20CB

Part Numbers	Descriptions
TM20CB	Marking label, blank
TM20CB-DH01	Marking label, horizontal (L1, L2, L3, N, PE repeated 40 times)
TM20CB-DH02	Marking label, horizontal (L1, L2, L3,N) repeated 40 times
TM20CB-FH01	Marking label, horizontal, 1 to 10, repeated in 20 lines
TM20CB-FH02	Marking label, horizontal, 11 to 20, repeated in 20 lines
TM20CB-FH03	Marking label, horizontal, 21 to 30, repeated in 20 lines
TM20CB-FH04	Marking label, horizontal, 31 to 40, repeated in 20 lines
TM20CB-FH05	Marking label, horizontal, 41 to 50, repeated in 20 lines
TM20CB-EH01	Marking label, horizontal, 1 to 50, repeated in 4 sets
TM20CB-EH02	Marking label, horizontal, 51 to 100, repeated in 4 sets
TM20CB-DV01	Marking label, vertical (L1, L2, L3, N, PE) repeated 40 times
TM20CB-DV02	Marking label, vertical, (L1, L2, L3, N) repeated 40 times
TM20CB-FV01	Marking label, vertical, 1 to 10, repeated in 20 lines
TM20CB-FV02	Marking label, vertical, 11 to 20, repeated in 20 lines
TM20CB-EV01	Marking label, vertical, 1 to 50, repeated in 4 sets

TM21CB

Part Numbers	Descriptions
TM21CB	Marking label, blank
TM21CB-DH01	Marking label, horizontal (L1, L2, L3, N, PE repeated 40 times)
TM21CB-DH02	Marking label, horizontal (L1, L2, L3,N) repeated 40 times
TM21CB-FH01	Marking label, horizontal, 1 to 10, repeated in 20 lines
TM21CB-FH02	Marking label, horizontal, 11 to 20, repeated in 20 lines
TM21CB-FH03	Marking label, horizontal, 21 to 30, repeated in 20 lines
TM21CB-FH04	Marking label, horizontal, 31 to 40, repeated in 20 lines
TM21CB-FH05	Marking label, horizontal, 41 to 50, repeated in 20 lines
TM21CB-EH01	Marking label, horizontal, 1 to 50, repeated in 4 sets
TM21CB-EH02	Marking label, horizontal, 51 to 100, repeated in 4 sets
TM21CB-DV01	Marking label, vertical (L1, L2, L3, N, PE) repeated 40 times
TM21CB-DV02	Marking label, vertical, (L1, L2, L3, N) repeated 40 times
TM21CB-FV01	Marking label, vertical, 1 to 10, repeated in 20 lines
TM21CB-FV02	Marking label, vertical, 11 to 20, repeated in 20 lines
TM21CB-EV01	Marking label, vertical, 1 to 50, repeated in 4 sets

TM21CB Series - mm

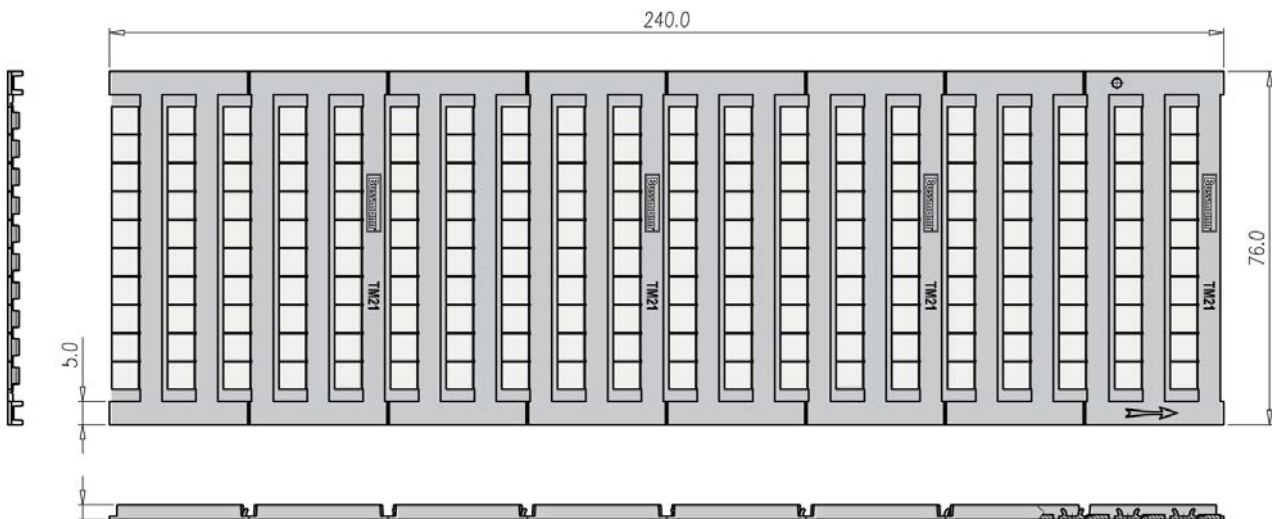

Marking Label Ordering Method (typical)

TM22CB Series - mm

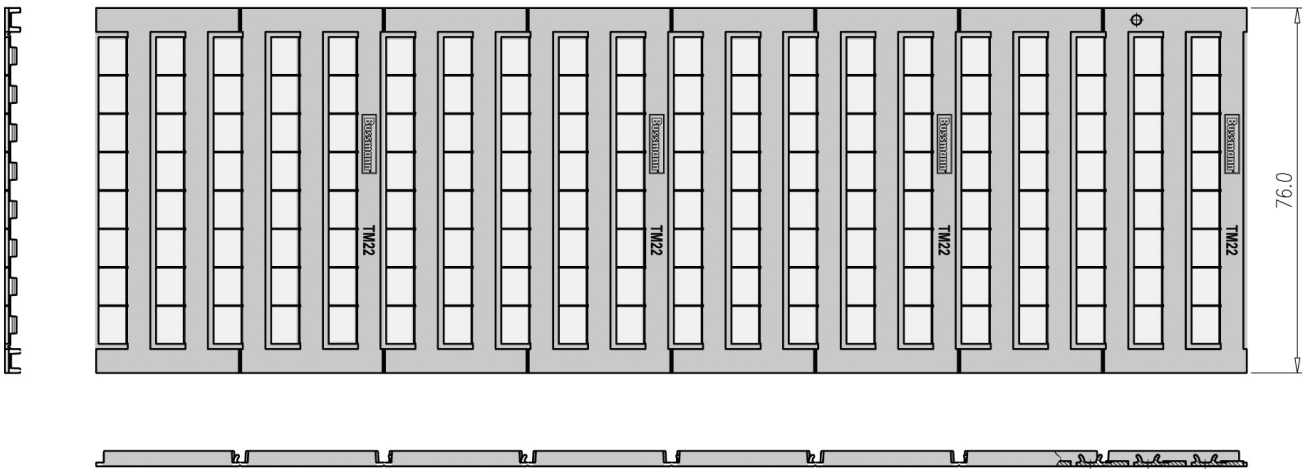

TM22CB

Part Numbers	Descriptions
TM22CB	Marking label, blank
TM22CB-DH01	Marking label, horizontal (L1, L2, L3, N, PE repeated 30 times)
TM22CB-DH02	Marking label, horizontal (L1, L2, L3,N) repeated 40 times
TM22CB-FH01	Marking label, horizontal, 1 to 10, repeated in 16 lines
TM22CB-FH02	Marking label, horizontal, 11 to 20, repeated in 16 lines
TM22CB-FH03	Marking label, horizontal, 21 to 30, repeated in 16 lines
TM22CB-FH04	Marking label, horizontal, 31 to 40, repeated in 16 lines
TM22CB-FH05	Marking label, horizontal, 41 to 50, repeated in 16 lines
TM22CB-EH01	Marking label, horizontal, 1 to 50, repeated in 3 sets
TM22CB-EH02	Marking label, horizontal, 51 to 100, repeated in 3 sets
TM22CB-DV01	Marking label, vertical (L1, L2, L3, N, PE) repeated 30 times
TM22CB-DV02	Marking label, vertical, (L1, L2, L3, N) repeated 40 times
TM22CB-FV01	Marking label, vertical, 1 to 10, repeated in 16 lines
TM22CB-FV02	Marking label, vertical, 11 to 20, repeated in 16 lines
TM22CB-EV01	Marking label, vertical, 1 to 50, repeated in 3 sets

TM26CB

Part Numbers	Descriptions
TM26CB	Marking label, blank
TM26CB-DH01	Marking label, horizontal (L1, L2, L3, N, PE) repeated 24 times
TM26CB-DH02	Marking label, horizontal (L1, L2, L3,N) repeated 36 times
TM26CB-FH01	Marking label, horizontal, 1 to 10, repeated in 12 lines
TM26CB-FH02	Marking label, horizontal, 11 to 20, repeated in 12 lines
TM26CB-FH03	Marking label, horizontal, 21 to 30, repeated in 12 lines
TM26CB-FH04	Marking label, horizontal, 31 to 40, repeated in 12 lines
TM26CB-FH05	Marking label, horizontal, 41 to 50, repeated in 12 lines
TM26CB-EH01	Marking label, horizontal, 1 to 50, repeated in 2 sets
TM26CB-EH02	Marking label, horizontal, 51 to 100, repeated in 2 sets
TM26CB-DV01	Marking label, vertical (L1, L2, L3, N, PE) repeated 24 times
TM26CB-DV02	Marking label, vertical, (L1, L2, L3, N) repeated 36 times
TM26CB-FV01	Marking label, vertical, 1 to 10, repeated in 12 lines
TM26CB-FV02	Marking label, vertical, 11 to 20, repeated in 12 lines
TM26CB-EV01	Marking label, vertical, 1 to 50, repeated in 2 sets

TM26CB Series - mm

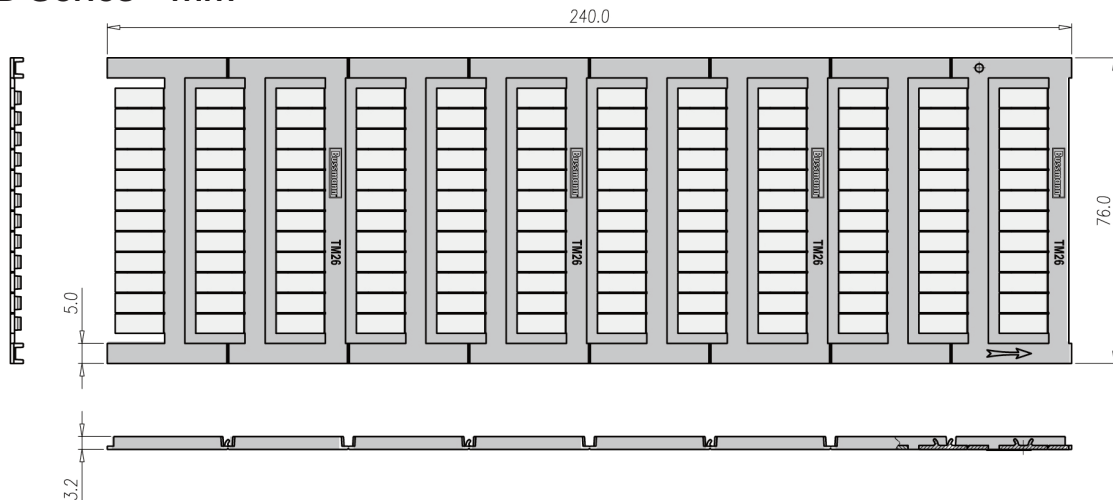

TM27CB Series - mm

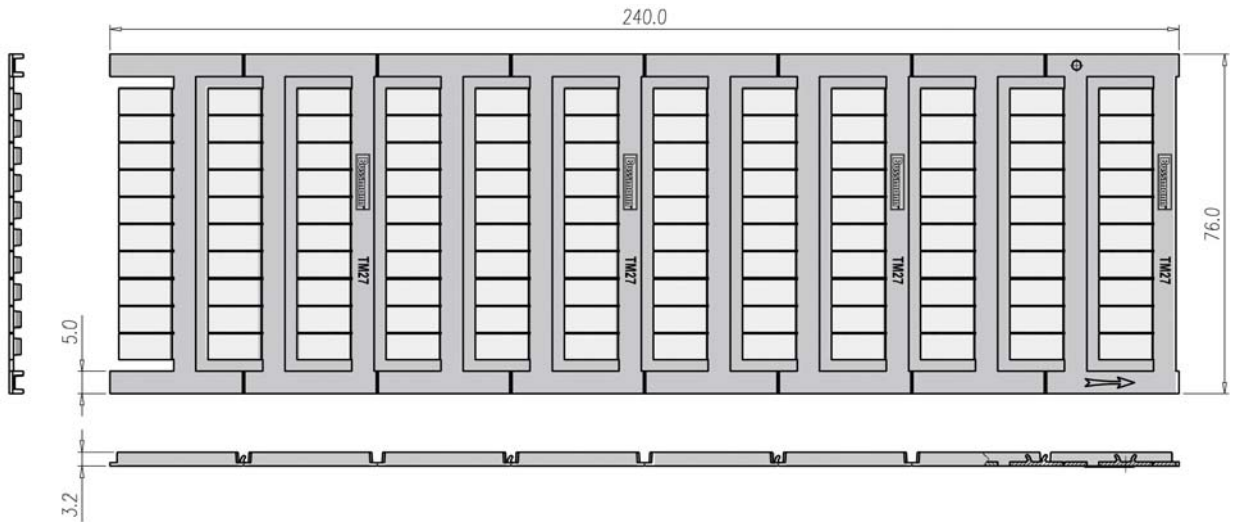

TM27CB

Part Numbers	Descriptions
TM27CB	Marking label, blank
TM27CB-DH01	Marking label, horizontal (L1, L2, L3, N, PE repeated 24 times)
TM27CB-DH02	Marking label, horizontal (L1, L2, L3, N) repeated 24 times
TM27CB-FH01	Marking label, horizontal, 1 to 10, repeated in 12 lines
TM27CB-FH02	Marking label, horizontal, 11 to 20, repeated in 12 lines
TM27CB-FH03	Marking label, horizontal, 21 to 30, repeated in 12 lines
TM27CB-FH04	Marking label, horizontal, 31 to 40, repeated in 12 lines
TM27CB-FH05	Marking label, horizontal, 41 to 50, repeated in 12 lines
TM27CB-EH01	Marking label, horizontal, 1 to 50, repeated in 2 sets
TM27CB-EH02	Marking label, horizontal, 51 to 100, repeated in 2 sets
TM27CB-DV01	Marking label, vertical (L1, L2, L3, N, PE) repeated 24 times
TM27CB-DV02	Marking label, vertical, (L1, L2, L3, N) repeated 24 times
TM27CB-FV01	Marking label, vertical, 1 to 10, repeated in 12 lines
TM27CB-FV02	Marking label, vertical, 11 to 20, repeated in 12 lines
TM27CB-EV01	Marking label, vertical, 1 to 50, repeated in 2 sets

TM28CB

Part Numbers	Descriptions
TM28CB	Marking label, blank
TM28CB-DH01	Marking label, horizontal (L1, L2, L3, N, PE) repeated 12 times
TM28CB-DH02	Marking label, horizontal (L1, L2, L3, N) repeated 20 times
TM28CB-FH01	Marking label, horizontal, 1 to 10, repeated in 8 lines
TM28CB-FH02	Marking label, horizontal, 11 to 20, repeated in 8 lines
TM28CB-FH03	Marking label, horizontal, 21 to 30, repeated in 8 lines
TM28CB-FH04	Marking label, horizontal, 31 to 40, repeated in 8 lines
TM28CB-FH05	Marking label, horizontal, 41 to 50, repeated in 8 lines
TM28CB-EH01	Marking label, horizontal, 1 to 50, repeated in 1 set
TM28CB-EH02	Marking label, horizontal, 51 to 100, repeated in 1 set
TM28CB-DV01	Marking label, vertical (L1, L2, L3, N, PE) repeated 12 times
TM28CB-DV02	Marking label, vertical, (L1, L2, L3, N) repeated 20 times
TM28CB-FV01	Marking label, vertical, 1 to 10, repeated in 8 lines
TM28CB-FV02	Marking label, vertical, 11 to 20, repeated in 8 lines
TM28CB-EV01	Marking label, vertical, 1 to 50, repeated in 1 set

TM28CB Series - mm

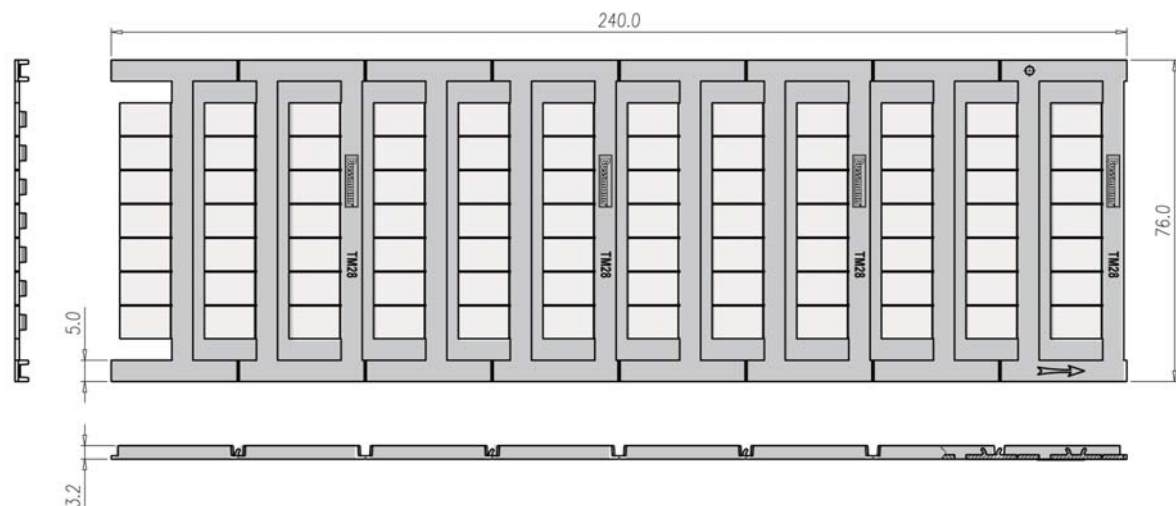

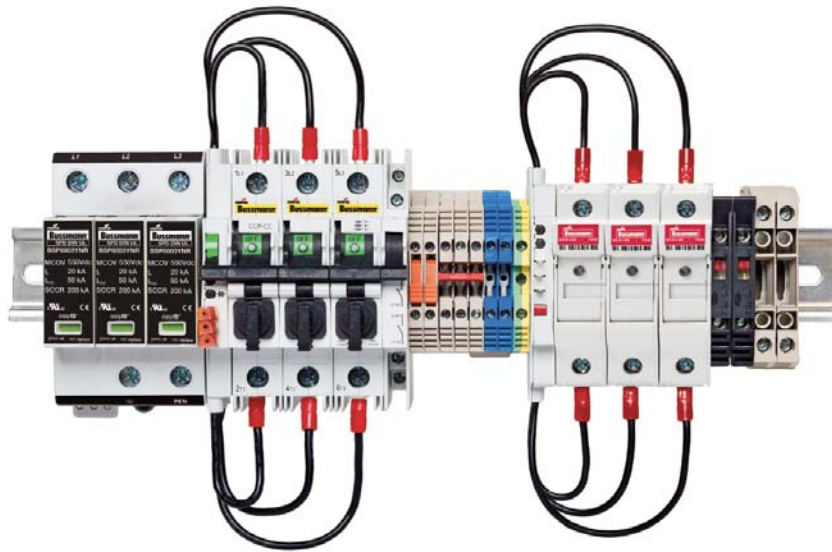

Modular Fuse Holders



Modular fuse holders for Class CC, 10x38 and Class J fuse links for remote PLC indication. Also available in size 14x51 and 22x58mm.

See page 27 - 31

NH Bases



Complete range of NH Bases to be used with 400, 500 and 690V NH gG and aM fuse links.

Available as DIN-Rail and/or screw mounting.

See page 33

Compact Circuit Protectors (CCP)



At 1/3 the space required by a molded case circuit breaker, the CCP saves space in your panel. High SCCR DIN-Rail mounted electrical disconnect.

See page 32

Surge Protective Devices



Full range of SPDs for Solar, IEC, UL high SCCR, Wind and Low Voltage AC/DC Power and Control applications. Industry's only true, UL 1449 3rd Edition compliant overvoltages protectors.

See page 34 - 35



CH Series

With a wide wire range and industry leading ratings - up to 32A, 1000V, 200kA SCCR - the new CH Series provide worldwide acceptance and easy specification - including the latest PV fuse holder standard: IEC 60269-1, -2 and UL4248-18. Use with midget, 10x38, PV or Class CC fuse links. Also certified to CCC standard (China Compulsory Certificate).

See brochure MFBRO0312

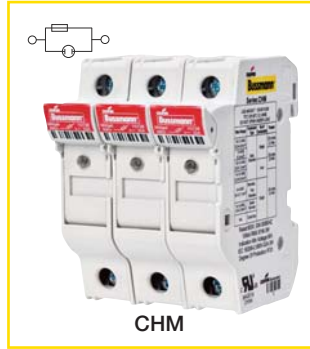

CHM

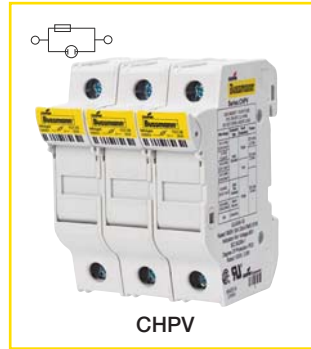

CHPV

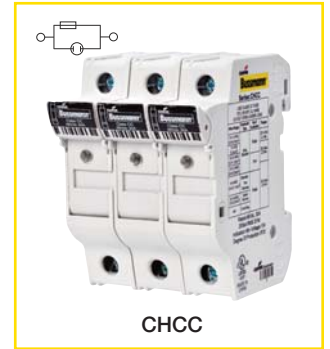

CHCC

Approval	CE	UL	SP	CCC
Technical Data	UL	IEC		
Rated Voltage	600Vac	690Vac		
Rated Current	30A	32A		
Conductor cross-section, solid (mm ²)	1 to 25			
Conductor cross-section, flexible (mm ²)	1 to 25			
Torque (N•m)	3.4			
SCCR	120kA			
W x H x D (mm)	17.5 x 73.9 x 61.8			
Fuse	Midget 10 x 38			
Multi-pole with Indicator	1-pole 2-pole 3-pole 4-pole	CHM1DIU CHM2DIU CHM3DIU CHM4DIU		
Multi-pole without Indicator	1-pole 2-pole 3-pole 4-pole	CHM1DU CHM2DU CHM3DU CHM4DU		
With Neutral Pole and Indicator	1-pole + Neutral 3-pole + Neutral	CHM1DNIU CHM3DNIU		
With Neutral Pole and no Indicator	1-pole + Neutral 3-pole + Neutral	CHM1DNU CHM3DNU		
Neutral only 48Vdc/30A	1-pole 1-pole	CHM1DNXU CHM1DI-48U		
Mounting Rail		DRL35MMHI DRL35MML0		
Tool				

Approval	CE	UL	SP	CCC
Technical Data	UL	IEC		
Rated Voltage	1000Vdc			
Rated Current	30A	32A		
Conductor cross-section, solid (mm ²)	1 to 25			
Conductor cross-section, flexible (mm ²)	1 to 25			
Torque (N•m)	3.4			
SCCR	33kA			
W x H x D (mm)	17.5 x 73.9 x 61.8			
Fuse	PV 10 x 38 10 x 38			
Multi-pole with Indicator	1-pole 2-pole 3-pole 4-pole	CHPV1IU CHPV2IU N/A N/A		
Multi-pole without Indicator	1-pole 2-pole 3-pole 4-pole	CHPV1U CHPV2U N/A N/A		
With Neutral Pole and Indicator	1-pole + Neutral 3-pole + Neutral	N/A N/A		
With Neutral Pole and no Indicator	1-pole + Neutral 3-pole + Neutral	N/A N/A		
Neutral only 48Vdc/30A	1-pole 1-pole	N/A N/A		
Mounting Rail		DRL35MMHI DRL35MML0		
Tool				

Approval	UL	SP	CCC
Technical Data	UL		
Rated Voltage	600Vac		
Rated Current	30A		
Conductor cross-section, solid (mm ²)	1 to 25		
Conductor cross-section, flexible (mm ²)	1 to 25		
Torque (N•m)	3.4		
SCCR	200kA		
W x H x D (mm)	17.5 x 73.9 x 61.8		
Fuse	Class CC		
Multi-pole with Indicator	1-pole 2-pole 3-pole 4-pole	CHCC1DIU CHCC2DIU CHCC3DIU N/A	
Multi-pole without Indicator	1-pole 2-pole 3-pole 4-pole	CHCC1DU CHCC2DU CHCC3DU N/A	
With Neutral Pole and Indicator	2-pole 4-pole	N/A N/A	
With Neutral Pole and no Indicator	1-pole + Neutral 3-pole + Neutral	N/A N/A	
Neutral only 48Vdc/30A	1-pole 1-pole	CHCC1DI-48U N/A	
Mounting Rail		DRL35MMHI DRL35MML0	
Tool			



Comb-Bus Bar

Easily distribute power in single-phase or three-phase configurations. Flexible cut-to-length solutions without compromising on the product's finger-safe features. Can be used with the CHM and CHCC Series.

See brochure MFBRO0312

Specifications

- Agency Information: UL 508. File E195399
- Pitch: 17.8mm
- SCCR: 10kA (default)
100kA (with upstream Class J 200A fuses)
- Max Current: 100A (power feed from end)
200A (power feed from center)
- Max Voltage: 600Vac/dc (three phase)
1000Vdc/600Vac (single phase)

Selection Guide

Part Number	Description
BB1P100M3	Single-phase 1000Vdc busbar, 100A, 3 pins, assembled endcap
BB1P100M6	Single-phase 1000Vdc busbar, 100A, 6 pins, assembled endcap
BB1P100M9	Single-phase 1000Vdc busbar, 100A, 9 pins, assembled endcap
BB1P100M12	Single-phase 1000Vdc busbar, 100A, 12 pins, assembled endcap
BB1P100M15	Single-phase 1000Vdc busbar, 100A, 15 pins, assembled endcap
BB1P100M57	Single-phase 1000Vdc cuttable busbar, 100A, 57 pins, without endcap
BB3P100M6	Three-phase 600V busbar, 100A, 6 pins, assembled endcap
BB3P100M9	Three-phase 600V busbar, 100A, 9 pins, assembled endcap
BB3P100M12	Three-phase 600V busbar, 100A, 12 pins, assembled endcap
BB3P100M15	Three-phase 600V busbar, 100A, 15 pins, assembled endcap
BB3P100M57	Three-phase 600V cuttable busbar, 100A, 57 pins, without endcap
ECAP1P	Single-phase busbar endcap
ECAPMP	Three-phase busbar endcap
PWR35MM	35mm ² feeder terminal for three-phase busbar (115A, 1000Vac/dc)
FSCVR	Spare contact safety protection covers
PWR1PLP	Single-phase low-profile feeder terminal (115A, 1000Vac/dc)
PWR50MM	50mm ² direct feed terminal (1000Vac/dc)

Typical Installation Example

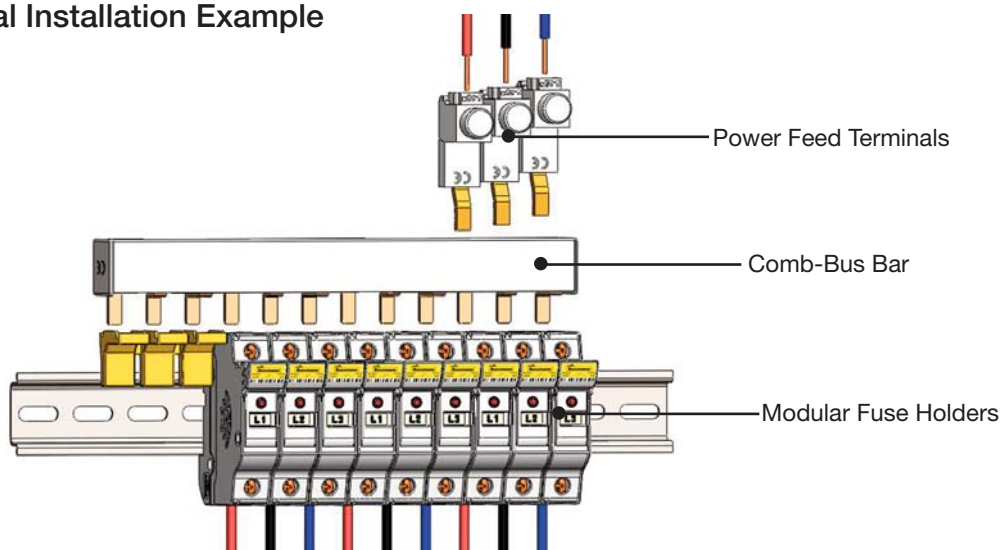

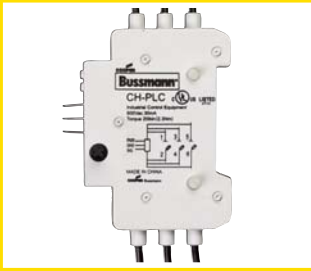

CH-PLC

Make it Simple with Cooper Bussmann resettable three-phase remote fuse monitor that integrates with a Programmable Logic Controller (PLC) or other monitoring and control equipment. Can be used with the CHM and CHCC Series.

See brochure MFBRO0312

Specifications

- Power Input: 24Vdc / 5mA
- Sensing Voltage: 600V/30mA
- Output Signals: Digital 0Vdc (Low), 24Vdc (High)
 - 0Vdc Low – Fuse is good
 - 24Vdc High – Fuse has opened

When the fuse opens, the output signal is sent high and will remain high until the unit is reset

- Rated Impulse Voltage: 8kV
- Local Indication: Two distinct LEDs indicate unit power (green) and open fuse (red). Upon the replacement of the fuse, the actuation of the reset switch will reset the open fuse LED
- Flammability Rating: UL 94V0

Wiring:

- For power, signal and ground connections use 22-24AWG (0.25mm²) 300V rated wire

Electromagnetic Compatibility (EMC) Testing:

- Electrostatic Discharge Immunity IEC 61000-4-2
- Electrical Fast Transient/Burst Immunity IEC 61000-4-4
- Surge Immunity IEC 61000-4-5

Packaging:

- The CH-PLC is packaged individually
- A single unit monitors up to three phases
- Package includes 0.11" (2.8mm) quick connects for power, signal and ground connections

Minimum Circuit Voltage:

- Minimum circuit voltage required across the CH holder is 100Vac for the remote indication device to operate

Installation Technique:

- Mounts on the left side of the fuse holder and mechanically interlocks with the fuse holder switch handle with hardware provided

IP20 Rating: Yes

Environmental Data:

- Storage and Operating Temperature: -20°C to 75°C

Agency Information:

- UL 508
- cULus to CSA Standard 22.2 No.14

PLC Programming:

- The CH-PLC signal line is designed to provide a digital input to a PLC I/O card.
- Programmable Logic Control program must be written to properly interpret the input signal to the PLC.
- The PLC program should check for consecutive high signals before taking action on a critical process.

De-energise all circuits before installing or removing any CH-PLC devices and follow all prescribed safety procedures.

Modular Fuse Holders - 14x51mm



CH14B Series

With a wide wire range and industry leading ratings - up to 50A, 1500Vdc, 200kA SCCR - the CH14B Series provide worldwide acceptance and easy specification.

Use with 14x51mm cylindrical fuse links, PVA14F photovoltaic fuse links and FW ferrule fuse links.

See data sheet 720148

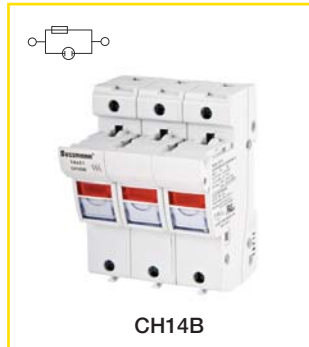

CH14B

Approval

Technical Data	IEC	UL
Rated Voltage	690Vac	750Vac
Rated Current	50A	50A
Conductor cross-section, solid (mm ²)	1.5-35mm ²	
Conductor cross-section, flexible (mm ²)	1.5-25mm ²	
Torque (N•m)	3	
SCCR	200kA	
W x H x D (mm)	26.5 x 110 x 76	

	Fuse	
		C14G and C14M
		FW ferrule
Multi-pole with Indicator	1-pole 2-pole 3-pole 4-pole	CH141BI CH142BI CH143BI CH144BI
Multi-pole without Indicator	1-pole 2-pole 3-pole 4-pole	CH141B CH142B CH143B CH144B
With Neutral Pole and Indicator	1-pole + Neutral 3-pole + Neutral	CH141BNI CH143BNI
With Neutral Pole and no Indicator	1-pole + Neutral 3-pole + Neutral	CH141BN CH143BN
Neutral only	1-pole	CH141BNX
With Microswitch fuse operation only	1-pole 3-pole	CH141BMS CH143BMS
With Microswitch pre-breaking/fuse operation/presence	1-pole 3-pole	CH141BMS-F CH143BMS-F
With Microswitch and Neutral	4-pole 4-pole	CH143DNMS CH14BNMS-F*
Mounting Rail		DRL35MMHI DRL35MML0
Tool		

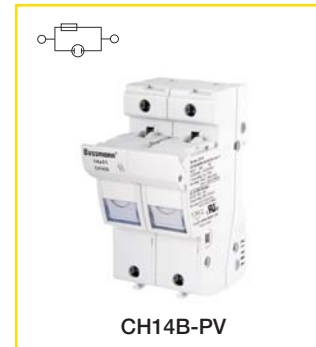

CH14B-PV

Approval

Technical Data	IEC
Rated Voltage	1500Vdc
Rated Current	32A
Conductor cross-section, solid (mm ²)	1.5-35mm ²
Conductor cross-section, flexible (mm ²)	1.5-25mm ²
Torque (N•m)	3
SCCR	200kA
W x H x D (mm)	26.5 x 110 x 49.5

	Fuse	
		PV-A14F
Multi-pole without Indicator	1-pole 2-pole	CH141B-PV CH142B-PV
Mounting Rail		DRL35MMHI DRL35MML0
Tool		

* pre-breaking/fuse operation/presence microswitch



CH22B Series

With a wide wire range and industry leading ratings - up to 125A, 750Vac, 200kA SCCR - the CH22B Series provide worldwide acceptance and easy specification.

Use with 22x58mm cylindrical fuse links and FW ferrule fuse links.

See data sheet 720150



CH22B

Approval

Technical Data	IEC	UL
Rated Voltage	690Vac	750Vac
Rated Current	125A	100A
Conductor cross-section, solid (mm ²)	1.5-50mm ²	
Conductor cross-section, flexible (mm ²)	1.5-35mm ²	
Torque (N•m)	4	
SCCR	200kA	
W x H x D (mm)	35 x 126.5 x 76	
Fuse	C22G and C22M	
	FW ferrule	
Multi-pole without Indicator	1-pole 2-pole 3-pole 4-pole	CH221B CH222B CH223B CH224B
With Neutral Pole	1-pole + Neutral 3-pole + Neutral	CH221BN CH223BN
Neutral only	1-pole	CH221BNX
With Microswitch (fuse operation)	1-pole + Neutral 3-pole + Neutral	CH221BMS CH223BMS
Mounting Rail	DRL35MMHI DRL35MMLO	
Tool		

Compact Circuit Protectors (CCP) Series



CCP Series

The revolutionary Cooper Bussmann CCP is 1/3 the footprint of a molded base circuit breaker. The level of protection provided by the CCP is up to three times the Short-Circuit Current Rating (SCCR) at full voltage than a molded case circuit breaker while providing disconnecting means.

See data sheet 1157

Specifications

- Box Lug and Spade Terminal suitable for line, load or accessory connection
- Box Lug Connection:
 - 18-6 AWG (1 to 16mm²) single or dual rated, solid or stranded – 75°C or higher - Cu only
 - 4 AWG (25mm²) single – 75°C or higher - Cu only
- Spade Terminal Connection:
 - Max. 30A suitable for use with #8-32 UNC (M4) screw
- Torque:
 - 18-10 AWG 20 Lb-In (1-6mm²/3.4N•m)
 - 8-4 AWG 35 Lb-In (10-25mm²/5.8N•m)
- Lockout/tagout: 4mm shank lock or standard pin-out devices
- 35mm DIN-Rail mount
- Dimensionally compliant to DIN 43880
- Local indication minimum operating voltage:
 - 90Vac for AC version
 - 12Vdc for DC version

Agency Information

UL Class CC fuse version

- UL 98 Listed, File E302370, Guide WHTY
- cULus to CSA Standard 22.2 No. 4-04, File 302370, Guide WHTY7
- CE Compliant

UL Midget fuse version

- UL 508 Listed
- cULus Certified 22.2 No. 14-05
- CE Compliant

10x38 IEC Class aM and gG/gL fuse version

- IEC 60947-3 AC23A
- IEC 60947-3 DC23A
- CE Compliant

Shipping Weight

- 2.84 lbs (1.29kg) per carton



NH Bases

NH fuse bases with thermoplastic bodies, DIN-Rail and/or screw mounting (size 4 screw mounting only).

Range of accessories available including phase barriers, IP20 finger-safe protection kits and neutral links. Microswitch also available for remote signaling of fuse link operation.

See data sheet 720136

Specifications

Catalogue Symbol:

SD(size)-D, SD(size)-S: 1-pole
TD(size)-D, TD(size)-DI: 3-pole
Size 4: SD4-S and SD4-S1600

Technical Data:

Rated Voltage: 690Vac
Rated Current: 160 - 1600A
Rated for Fuse Links with Breaking Capacity: 120kA

Features

- Complies with IEC 60269-1 and 2 fuse system A (NH base), manufacturers' type test certificates of compliance available.
- 3-Pole integral NH00 base available with reduced width.
- Clip-in phase barriers, terminal shrouds and fuse covers available.
- Vibration tested to IEC 60068-2-6 for marine use.
- Full range of accessories available.

Agency Information

- IEC 60269-1 and 2
- VDE 0636-1 and 2

Surge Protective Devices



SPD Series

Surge Protection Made Simple™
High performance lightning and surge protection products for all photovoltaic, IEC, wind and power applications.

Modular 35mm DIN-Rail design with colour-coding and rejection features makes it easy to identify, install and maintain.



SPD PV

Patented, Fast-Acting and Safe Surge Protection Solutions for Global Photovoltaic Solutions

- Patented, fast-acting Short-Circuit Interrupting (SCI) technology responds efficiently to overvoltage conditions.
- Built-in overcurrent protection eliminates the need for any additional fuse installation and wiring.
- *easyID*™ Visual indication and optional remote contact signaling make status monitoring simple.
- Modular DIN-Rail design with color-coding and rejection feature makes it easy to identify, install and maintain.

For further details see data sheets:

- Class I
- Lightning Arrester One-Pole # 2148
- Class II
- Surge Arrester Two modules # 2145
- Surge Arrester Three Modules # 2055



SPD IEC

High Performance Lightning and Surge Protection Products for all IEC Applications

- Vibration and shock resistant according to EN 60068-2 standards.
- *easyID*™ Visual indication and optional remote contact signaling make status monitoring simple.
- High surge discharge capacity due to heavy-duty zinc oxide varistor and spark gap technology.
- Wide range of IEC Class I and Class II SPD covering all the major markets around the world.
- Modular DIN-Rail design with color-coding and rejection features makes it easy to identify, install and maintain.

For further details see data sheets:

- Class I:
- 2-Pole # 1163
- 3-Pole # 1164
- 4-Pole # 1165
- Class II:
- 1-Pole # 1166
- 2-Pole # 1167
- 3-Pole # 1168
- 4-Pole # 1169



SPD UL SCCR

Comprehensive High SCCR Surge Protection Solutions for North American UL 508A Applications

- UL 1449 3rd Edition Recognised SPD devices provide optimum surge protection for the United States and Canadian panel markets.
- Modular DIN-Rail design with color coding and rejection feature makes it easy to identify, install and maintain.
- *easyID*™ Visual indication and optional remote contact signaling make status monitoring simple.
- Vibration and shock resistant according to EN 60068-2 standards to withstand harsh environments.
- IP20 Finger-safe design improves electrical safety.

For further details see data sheets:

- 1-Pole # 2149
- 2-Pole # 2150
- 3-Pole # 2151
- 4-Pole # 2152



SPD Wind

Advanced, Easy-to-Use Surge & Lightning Protection Products for Wind Power Systems

- Modular DIN-Rail design with color-coding and rejection features makes it easy to identify, install and maintain.
- High surge discharge capacity due to heavy-duty zinc oxide varistor and spark-gap technology.
- easyID™ Visual indication and optional remote contact signaling make status monitoring simple.
- Vibration and shock resistant according to EN 60068-2 standards.
- Wide range of IEC Class I and Class II SPD covering all the major markets around the world.

For further details see data sheets:

- Class I:
 - 1-Pole # 2091
- Class II:
 - 1-Pole # 2092
 - 2-Pole # 2093
 - 3-Pole # 2094
 - 4-Pole # 2095



SPD Low Voltage AC/DC Power & Control

Efficient and reliable Network Protection for Low Voltage and Telecommunication Applications.

- Modular DIN-Rail design with color-coding and rejection feature makes it easy to identify, install and maintain.
- High surge discharge capacity provided by combination of spark-gap and heavy-duty zinc oxide varistor.
- easyID™ Visual indication and optional remote contact signaling make status monitoring simple.
- Vibration and shock resistant according to EN 60068-2 standards.
- Energy coordination with other Cooper Bussmann DIN-Rail surge protective devices

For further details see data sheets:

- Type 2:
 - 1-Pole Power # 2056
- Type 3:
 - 2-Pole Control # 2057

Customer Assistance

Customer Satisfaction Team

The Cooper Bussmann Customer Satisfaction Team is available to answer questions regarding Cooper Bussmann products.

Europe calls can be made between:

Monday - Thursday 7.30 a.m. - 5.30 p.m. GMT
Friday 7.30 a.m. - 5.00 p.m. GMT

The Customer Service Satisfaction Team can be reached via:

- Phone: 00 44 (0) 1509 882 600
- Fax: 00 44 (0) 1509 882 786
- Email: bulesales@cooperindustries.com

C³ Cooper Customer Center

The Cooper C³ portal supports the following Cooper Divisions: Cooper B-Line, Cooper Bussmann, Cooper Crouse-Hinds, Cooper Lighting, Cooper Power Systems, Cooper Safety, and Cooper Wiring Devices.

Get started today at WWW.COOPERC3.COM by clicking Request User ID and Password.

- Easy to Navigate
- Simple to Use
- Real-Time Data

Online Resources

Visit www.cooperbussmann.com for the following resources:

- Product cross reference
- Product profiles
- Online catalogues for the latest United States and European catalogues

Application Engineering

Application Engineering assistance is available to all customers. The Application Engineering team is staffed by university-qualified electrical engineers who are available with technical and application support.

Europe calls can be made between:

Monday - Thursday 8.30 a.m. - 4.30 p.m. GMT
Friday 8.30 a.m. - 4.00 p.m. GMT

Application Engineering can be reached via:

- Phone: 00 44 (0) 1509 882 699
- Fax: 00 44 (0) 1509 882 794
- Email: buletechnical@cooperindustries.com

© 2012 Cooper Bussmann (UK) Ltd
Melton Road
Burton-on-the-Wolds, LE12 5TH, United Kingdom
P: 00 44 (0) 1509 882 600
www.cooperbussmann.com



Your authorised Cooper Bussmann Distributor is







Cooper Industries plc.
Unit F10, Maynooth Business Campus
Maynooth, Ireland
www.cooperindustries.com

Looking for pricing, stock, or lifecycle information?

Click below to explore more details on WIN SOURCE:

-  [View CSC-2-510P on WIN SOURCE](#)
-  [Eaton Bussmann Information](#)

Optimize Your Supply Chain with WIN SOURCE Solutions

-  Global Sourcing Solution
-  Obsolete Management
-  Cost Control Management
-  Shortage Management
-  Alternative Solution
-  Excess Inventory Management