

CAT811

4-Pin Microprocessor Power Supply Supervisor with Manual Reset

Description

The CAT811 is a microprocessor supervisory circuit that monitors power supplies. The CAT811 is a direct replacement for the MAX811 in applications operating over the industrial temperature range and has a manual reset input.

These devices generate a reset signal, which is asserted while the power supply voltage is below a preset threshold level and for at least 140 ms after the power supply level has risen above that level. The underlying floating gate technology, Analog EEPROM used by ON Semiconductor, makes it possible to offer any custom reset threshold value. Seven industry standard threshold levels are offered to support +5.0 V, +3.3 V, +3.0 V and +2.5 V systems. The CAT811 features a RESET push-pull output (active LOW).

Fast transients on the power supply are ignored and the output is guaranteed to be in the correct state at V_{CC} levels as low as 1.0 V.

The CAT811 is fully specified over the industrial temperature range (−40°C to 85°C) and is available in a compact 4-pin SOT-143 package.

Features

- Precision Monitoring of
+5.0 V (± 5%, ± 10%, ± 20%),
+3.3 V (± 5%, ± 10%)
- Manual Reset Input
- Output Configuration: Active LOW Reset
- Direct Replacements for the MAX811 in Applications Operating over the Industrial Temperature Range
- Reset Valid down to V_{CC} = 1.0 V
- 6 μA Power Supply Current
- Power Supply Transient Immunity
- Available in SOT-143 Packages with Sn or NiPdAu Green Lead Finishes
- Industrial Temperature Range: −40°C to +85°C
- These Devices are Pb-Free, Halogen Free/BFR Free and are RoHS Compliant

Applications

- Computers, Servers, Laptops and Cable Modems
- Wireless Communications
- Embedded Control Systems
- White Goods, Power Meters
- Intelligent Instruments
- PDAs and Handheld Equipment



ON Semiconductor®

www.onsemi.com

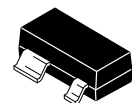

SOT-143
BI SUFFIX
CASE 527AF

PIN CONFIGURATION

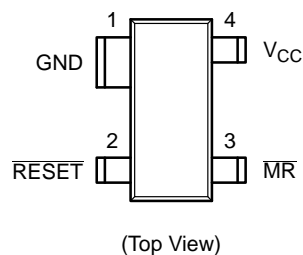

MARKING DIAGRAM

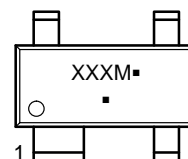

XXX = Specific Device Code
M = Month Code
▪ = Pb-Free Package

(Note: Microdot may be in either location)

ORDERING INFORMATION

See detailed ordering and shipping information in the package dimensions section on page 9 of this data sheet.

CAT811

Table 3. ABSOLUTE MAXIMUM RATINGS

Parameters	Ratings	Units
Any pin with respect to ground	-0.3 to +6.0	V
Input Current, V_{CC}	20	mA
Output Current $\overline{\text{RESET}}$	20	mA
Rate of Raise, V_{CC}	100	V/ μ s
Continuous Power Dissipations Derate 4 mW/ $^{\circ}$ C above +70 $^{\circ}$ C (SOT-143)	320	mW
Storage Temperature Range	-65 to +105	$^{\circ}$ C
Operating Ambient Temperature Range	-40 to +85	$^{\circ}$ C
Lead Soldering Temperature (10 seconds)	+300	$^{\circ}$ C

Stresses exceeding those listed in the Maximum Ratings table may damage the device. If any of these limits are exceeded, device functionality should not be assumed, damage may occur and reliability may be affected.

Table 4. ELECTRICAL OPERATING CHARACTERISTICS

(V_{CC} = Full range, T_A = -40 $^{\circ}$ C to +85 $^{\circ}$ C unless otherwise noted. Typical values at T_A = +25 $^{\circ}$ C and V_{CC} = 5 V for the L version, V_{CC} = 3.3 V for the T/S versions.)

Parameter	Symbol	Conditions	Min	Typ	Max	Units	
V_{CC} Range		T_A = 0 $^{\circ}$ C to +70 $^{\circ}$ C	1.0		5.5	V	
		T_A = -40 $^{\circ}$ C to +85 $^{\circ}$ C	1.2		5.5		
Supply Current	I_{CC}	T_A = -40 $^{\circ}$ C to +85 $^{\circ}$ C	V_{CC} < 5.5 V, L		8	20	μ A
			V_{CC} < 3.6 V, S/T		6	15	
Reset Threshold Voltage	V_{TH}	L Threshold	T_A = +25 $^{\circ}$ C	4.56	4.63	4.70	V
			T_A = -40 $^{\circ}$ C to +85 $^{\circ}$ C	4.50		4.75	
		T Threshold	T_A = +25 $^{\circ}$ C	3.04	3.08	3.11	
			T_A = -40 $^{\circ}$ C to +85 $^{\circ}$ C	3.00		3.15	
		S Threshold	T_A = +25 $^{\circ}$ C	2.89	2.93	2.96	
			T_A = -40 $^{\circ}$ C to +85 $^{\circ}$ C	2.85		3.00	
Reset Threshold Tempco				30		ppm/ $^{\circ}$ C	
V_{CC} to Reset Delay (Note 3)		$V_{CC} = V_{TH}$ to ($V_{TH} - 100$ mV)		20		μ s	
Reset Active Timeout Period		T_A = -40 $^{\circ}$ C to +85 $^{\circ}$ C	140	240	400	ms	

1. Production testing done at T_A = +25 $^{\circ}$ C; limits over temperature guaranteed by design only.
2. Glitches of 100 ns or less typically will not generate a reset pulse.
3. $\overline{\text{RESET}}$ output for the CAT811.

CAT811

Table 4. ELECTRICAL OPERATING CHARACTERISTICS

(V_{CC} = Full range, T_A = -40°C to $+85^{\circ}\text{C}$ unless otherwise noted. Typical values at T_A = $+25^{\circ}\text{C}$ and V_{CC} = 5 V for the L version, V_{CC} = 3.3 V for the T/S versions.)

Parameter	Symbol	Conditions	Min	Typ	Max	Units
RESET Output Voltage Low (Push-pull, active LOW, CAT811)	V_{OL}	$V_{CC} = V_{TH\ min}$, $I_{SINK} = 1.2\ \text{mA}$ CAT811S/T			0.3	V
		$V_{CC} = V_{TH\ min}$, $I_{SINK} = 3.2\ \text{mA}$ CAT811L			0.4	
		$V_{CC} > 1.0\ \text{V}$, $I_{SINK} = 50\ \mu\text{A}$			0.3	
RESET Output Voltage High (Push-pull, active LOW, CAT811)	V_{OH}	$V_{CC} = V_{TH\ max}$, $I_{SOURCE} = 500\ \mu\text{A}$ CAT811S/T	$0.8V_{CC}$			V
		$V_{CC} = V_{TH\ max}$, $I_{SOURCE} = 800\ \mu\text{A}$ CAT811L	$V_{CC} - 1.5$			V
$\overline{\text{MR}}$ Minimum Pulse Width	t_{MR}		10			μs
$\overline{\text{MR}}$ Glitch Immunity		(Note 2)		100		ns
$\overline{\text{MR}}$ to RESET Propagation Delay	t_{MD}	(Note 3)		0.5		μs
$\overline{\text{MR}}$ Input Threshold	V_{IH}	$V_{CC} > V_{TH\ (MAX)}$, CAT811L	2.3V			V
	V_{IL}				0.8	
	V_{IH}	$V_{CC} > V_{IH\ (MAX)}$, CAT811S/T	$0.7V_{CC}$			
	V_{IL}				$0.25V_{CC}$	
$\overline{\text{MR}}$ Pull-up Resistance			10	20	75	$\text{k}\Omega$

1. Production testing done at $T_A = +25^{\circ}\text{C}$; limits over temperature guaranteed by design only.
2. Glitches of 100 ns or less typically will not generate a reset pulse.
3. RESET output for the CAT811.

CAT811

TYPICAL OPERATING CHARACTERISTICS

(V_{CC} = Full range, T_A = -40°C to $+85^{\circ}\text{C}$ unless otherwise noted. Typical values at T_A = $+25^{\circ}\text{C}$ and V_{CC} = 5 V for the L version, V_{CC} = 3.3 V for the T/S versions.)

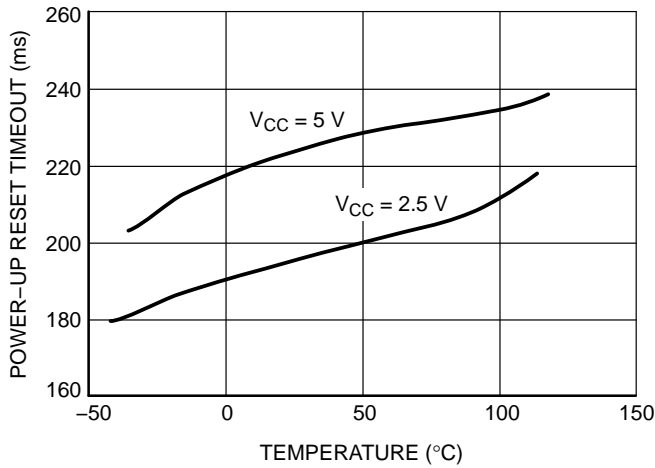

Figure 2. Power-Up Reset Timeout vs. Temperature

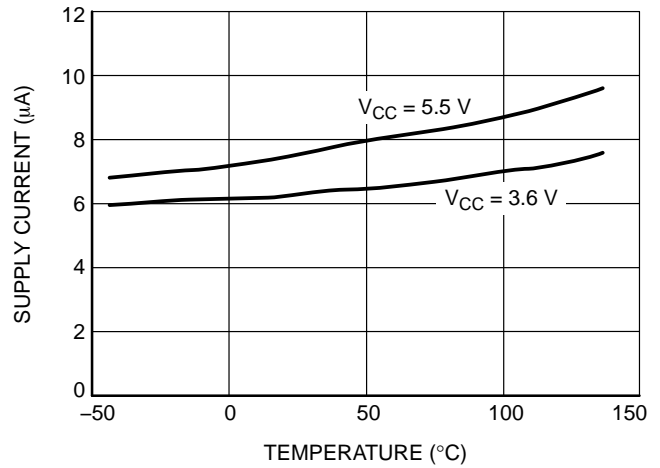

Figure 3. Supply Current vs. Temperature (No Load, CAT811S/T)

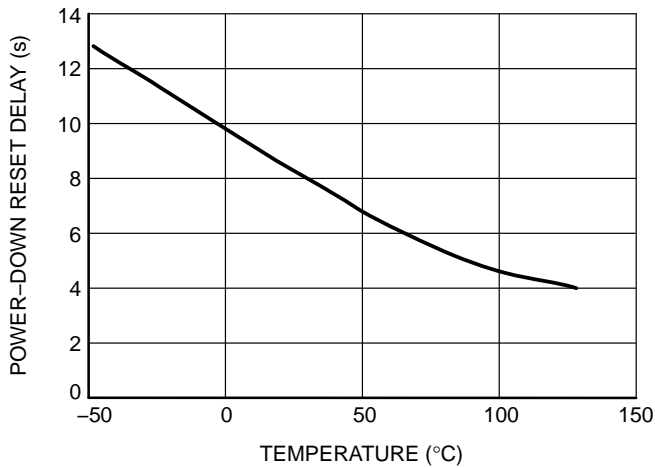

Figure 4. Power-Down Reset Delay vs. Temperature (CAT811S/T)

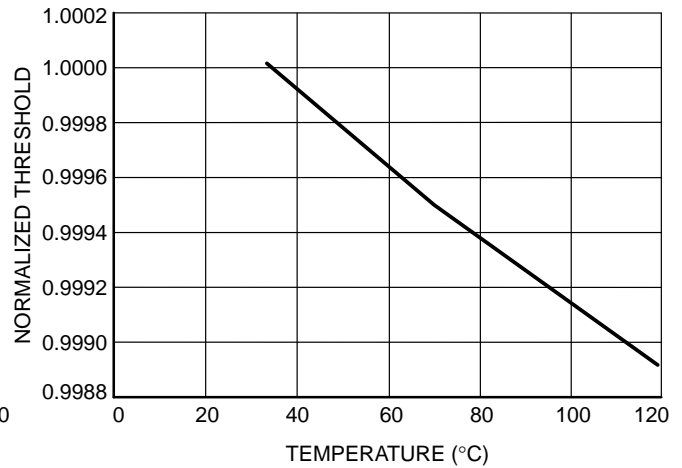

Figure 5. Normalized Reset Threshold vs. Temperature

CAT811

DETAILED DESCRIPTION

Reset Timing

The reset signal is asserted LOW for the CAT811 when the power supply voltage falls below the threshold trip voltage and remains asserted for at least 140 ms after the power supply voltage has risen above the threshold.

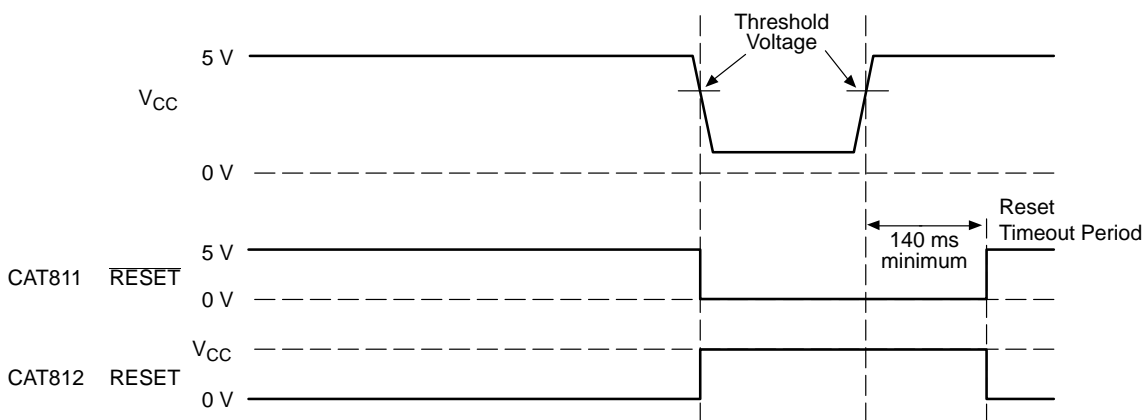

Figure 6. Reset Timing Diagram

V_{CC} Transient Response

The CAT811 protect μ Ps against brownout failure. Short duration transients of 4 μ s or less and 100 mV amplitude typically do not cause a false RESET.

Figure 7 shows the maximum pulse duration of negative-going V_{CC} transients that do not cause a reset condition. As the amplitude of the transient goes further below the threshold (increasing V_{TH} - V_{CC}), the maximum pulse duration decreases. In this test, the V_{CC} starts from an initial voltage of 0.5 V above the threshold and drops below it by the amplitude of the overdrive voltage (V_{TH} - V_{CC}).

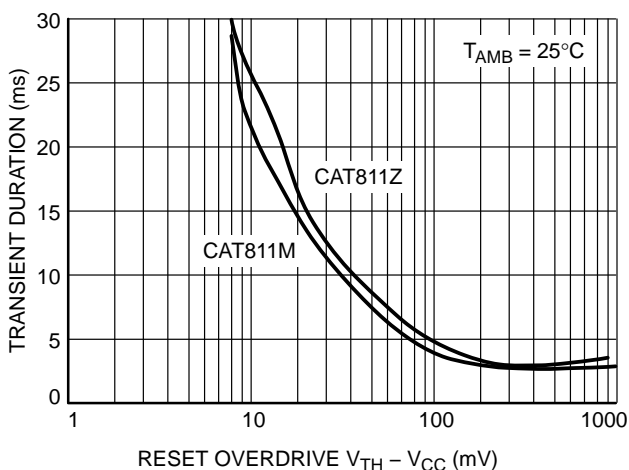

Figure 7. Maximum Transient Duration without Causing a Reset Pulse vs. Reset Comparator Overdrive

Valid Reset with V_{CC} under 1.0 V

To ensure that the CAT811 $\overline{\text{RESET}}$ pin is in a known state when V_{CC} is under 1.0 V, a 100 k Ω pull-down resistor between $\overline{\text{RESET}}$ pin and GND is recommended; the value is not critical.

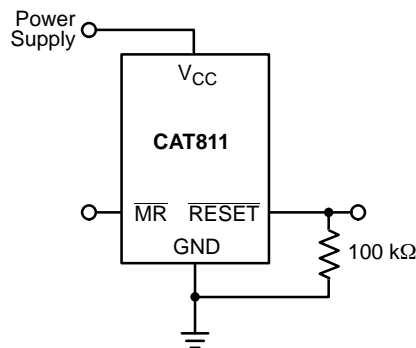

Figure 8. $\overline{\text{RESET}}$ Valid with V_{CC} Under 1.0 V

CAT811

Bi-directional Reset Pin Interfacing

The CAT811 can interface with $\mu\text{P}/\mu\text{C}$ bi-directional reset pins by connecting a 4.7 k Ω resistor in series with the CAT811 reset output and the $\mu\text{P}/\mu\text{C}$ bi-directional reset pin.

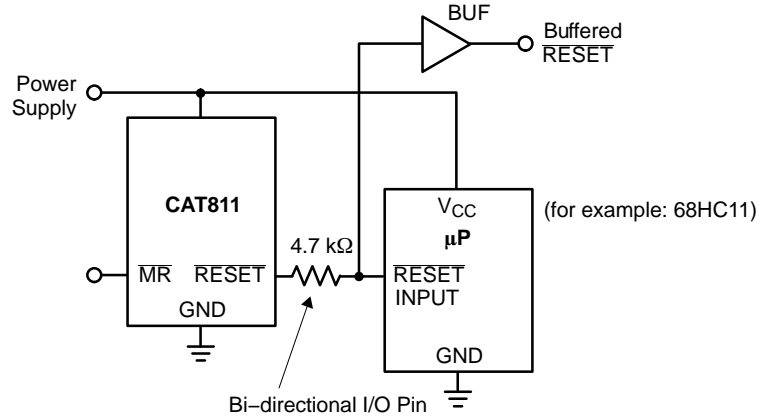

Figure 9. Bi-directional Reset Pin Interfacing

Table 5. OTHER SUPERVISORY PRODUCTS

Function	CAT1161/3	CAT1162	CAT809	CAT810	CAT811
With 16k Bit Serial EEPROM Memory	✓	✓			
Watchdog Timer	✓				
Manual Reset Input	✓	✓			✓
Active Low Reset			✓		✓
Active High Reset				✓	
Dual Polarity Reset Outputs	✓	✓			
Package	8-pin DIP and SOIC	8-pin DIP and SOIC	3-pin SOT-23 and SC70	3-pin SOT-23 and SC70	4-pin SOT-143

CAT811

PACKAGE DIMENSIONS

SOT-143, 4 Lead
CASE 527AF-01
ISSUE A

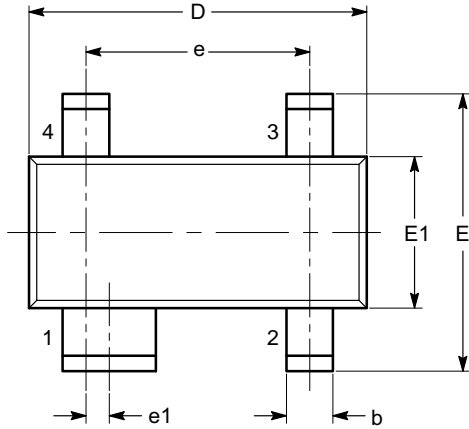

TOP VIEW

SYMBOL	MIN	NOM	MAX
A	0.80		1.22
A1	0.05		0.15
A2	0.75	0.90	1.07
b	0.30		0.50
b2	0.76		0.89
c	0.08		0.20
D	2.80	2.90	3.04
E	2.10		2.64
E1	1.20	1.30	1.40
e	1.92 BSC		
e1	0.20 BSC		
L	0.40	0.50	0.60
L1	0.54 REF		
L2		0.25	
θ	0°		8°

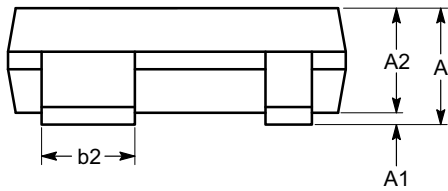

SIDE VIEW

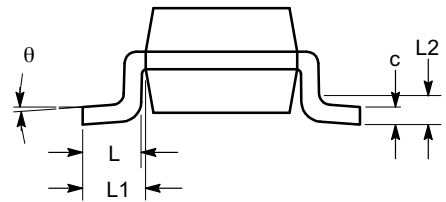

END VIEW

Notes:

- (1) All dimensions are in millimeters. Angles in degrees.
- (2) Complies with JEDEC TO-253.

CAT811

ORDERING INFORMATION

Order Number	Voltage	Top Mark (Note 4)	Output	Reset	Package	Quantity per Reel (Note 5)
NiPdAu		NiPdAu				
CAT811LTBI-GT3	4.63 V	VEA	Manual Reset	LOW	SOT-143-4	3,000
CAT811MTBI-GT3	4.38 V	VEA				
CAT811JTBI-GT3	4.00 V	VEA				
CAT811TTBI-GT3	3.08 V	VEA				
CAT811STBI-GT3	2.93 V	VEA				
CAT811RTBI-GT3	2.63 V	VEA				
CAT811ZTBI-GT3	2.32 V	VEA				

- Threshold and full part numbers will be provided on box and reel labels as well as all Shipping documents.
- For information on tape and reel specifications, including part orientation and tape sizes, please refer to our Tape and Reel Packaging Specifications Brochure, BRD8011/D.
- For detailed information and a breakdown of device nomenclature and numbering systems, please see the ON Semiconductor Device Nomenclature document, TND310/D, available at www.onsemi.com

ON Semiconductor and  are registered trademarks of Semiconductor Components Industries, LLC (SCILLC). SCILLC reserves the right to make changes without further notice to any products herein. SCILLC makes no warranty, representation or guarantee regarding the suitability of its products for any particular purpose, nor does SCILLC assume any liability arising out of the application or use of any product or circuit, and specifically disclaims any and all liability, including without limitation special, consequential or incidental damages. "Typical" parameters which may be provided in SCILLC data sheets and/or specifications can and do vary in different applications and actual performance may vary over time. All operating parameters, including "Typicals" must be validated for each customer application by customer's technical experts. SCILLC does not convey any license under its patent rights nor the rights of others. SCILLC products are not designed, intended, or authorized for use as components in systems intended for surgical implant into the body, or other applications intended to support or sustain life, or for any other application in which the failure of the SCILLC product could create a situation where personal injury or death may occur. Should Buyer purchase or use SCILLC products for any such unintended or unauthorized application, Buyer shall indemnify and hold SCILLC and its officers, employees, subsidiaries, affiliates, and distributors harmless against all claims, costs, damages, and expenses, and reasonable attorney fees arising out of, directly or indirectly, any claim of personal injury or death associated with such unintended or unauthorized use, even if such claim alleges that SCILLC was negligent regarding the design or manufacture of the part. SCILLC is an Equal Opportunity/Affirmative Action Employer. This literature is subject to all applicable copyright laws and is not for resale in any manner.

PUBLICATION ORDERING INFORMATION

LITERATURE FULFILLMENT:

Literature Distribution Center for ON Semiconductor
P.O. Box 5163, Denver, Colorado 80217 USA
Phone: 303-675-2175 or 800-344-3860 Toll Free USA/Canada
Fax: 303-675-2176 or 800-344-3867 Toll Free USA/Canada
Email: orderlit@onsemi.com

N. American Technical Support: 800-282-9855 Toll Free
USA/Canada
Europe, Middle East and Africa Technical Support:
Phone: 421 33 790 2910
Japan Customer Focus Center
Phone: 81-3-5817-1050

ON Semiconductor Website: www.onsemi.com

Order Literature: <http://www.onsemi.com/orderlit>

For additional information, please contact your local Sales Representative

Looking for pricing, stock, or lifecycle information?

Click below to explore more details on WIN SOURCE:

 [View CAT811STBI-T3 on WIN SOURCE](#)

 [ON Semiconductor](#) Information

Optimize Your Supply Chain with WIN SOURCE Solutions

-  Global Sourcing Solution
-  Obsolete Management
-  Cost Control Management
-  Shortage Management
-  Alternative Solution
-  Excess Inventory Management