



**THE DATASHEET OF
IFX27001TFV33ATMA1**



IFX27001

Linear Voltage Regulator

IFX27001TFV15
IFX27001TFV18
IFX27001TFV26
IFX27001TFV33

Data Sheet

Rev. 1.01, 2009-10-19

Standard Power



1 Overview

Features

- 1.5V, 1.8V, 2.6V, 3.3 V, 5.0V or Adj. output voltage
- 1.0 A output current
- Low dropout voltage, 1 V (typ.)
- Short circuit protection
- Overtemperature protection
- Input Voltage up to 40 V
- Wide temperature range of $T_j = -40$ to 125 °C
- Green Product (RoHS compliant)



PG-TO252-3

Applications

- Manufacturing Automation
- Appliances
- HDTV Televisions
- Game Consoles
- Network Routers

For automotive and transportation applications, please refer to the Infineon TLE and TLF voltage regulator series

Description

The IFX27001 is a monolithic integrated NPN type voltage regulator that can supply loads up to 1.0 A. The chip is housed in a surface mount PG-TO252-3 package (DPAK). It is designed to supply microprocessor systems or other loads under the severe conditions and therefore it is equipped with additional protection against overload, short circuit and overtemperature.

An large input voltage V_I in the range of $(V_Q + V_{DR}) < V_I < 40$ V is regulated to V_Q . The dropout voltage V_{DR} ranges from 1.1 V to 1.4 V depending on the load current level.

The device operates in the temperature range of $T_j = -40$ to 125 °C..

Type	Package	Marking
IFX27001TFV15	PG-TO252-3	2700115
IFX27001TFV18	PG-TO252-3	2700118
IFX27001TFV26	PG-TO252-3	2700126
IFX27001TFV33	PG-TO252-3	2700133
IFX27001TFV50	PG-TO252-3	2700150
IFX27001TFV	PG-TO252-3	27001V

2 Block Diagram

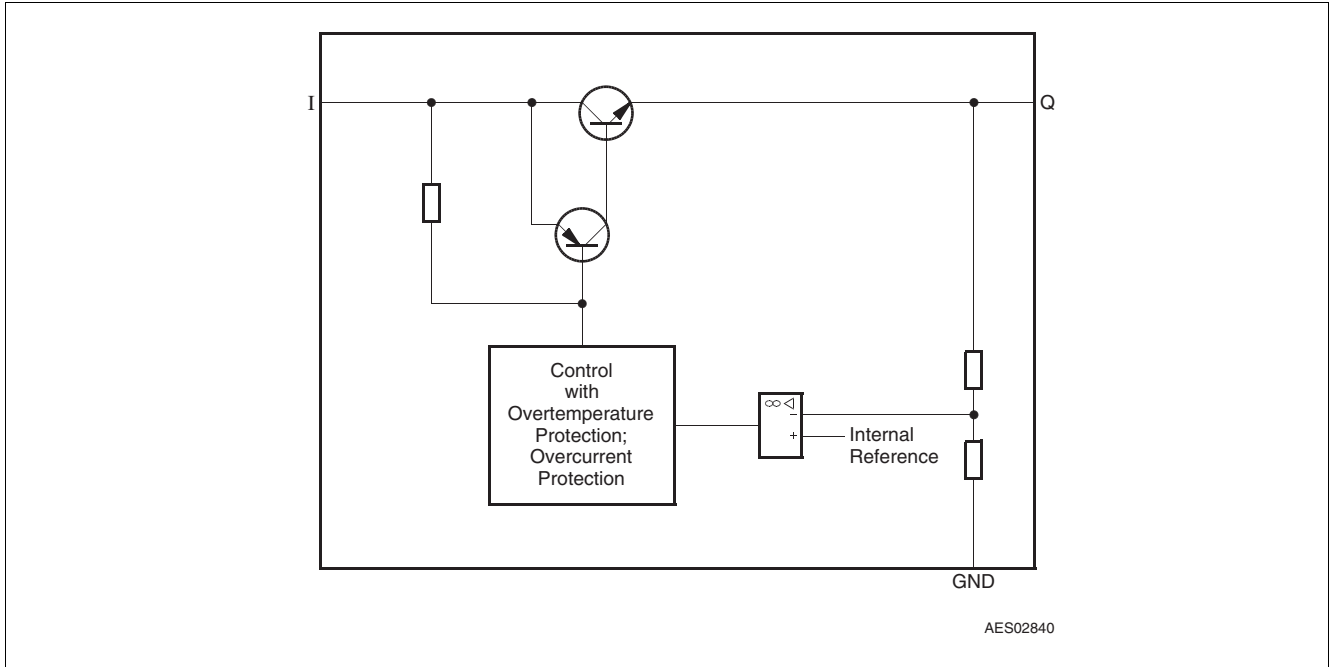

Figure 1 Block Diagram for Fixed Output Voltage (1.5V, 1.8V, 2.6V, 3.3V, 5.0V)

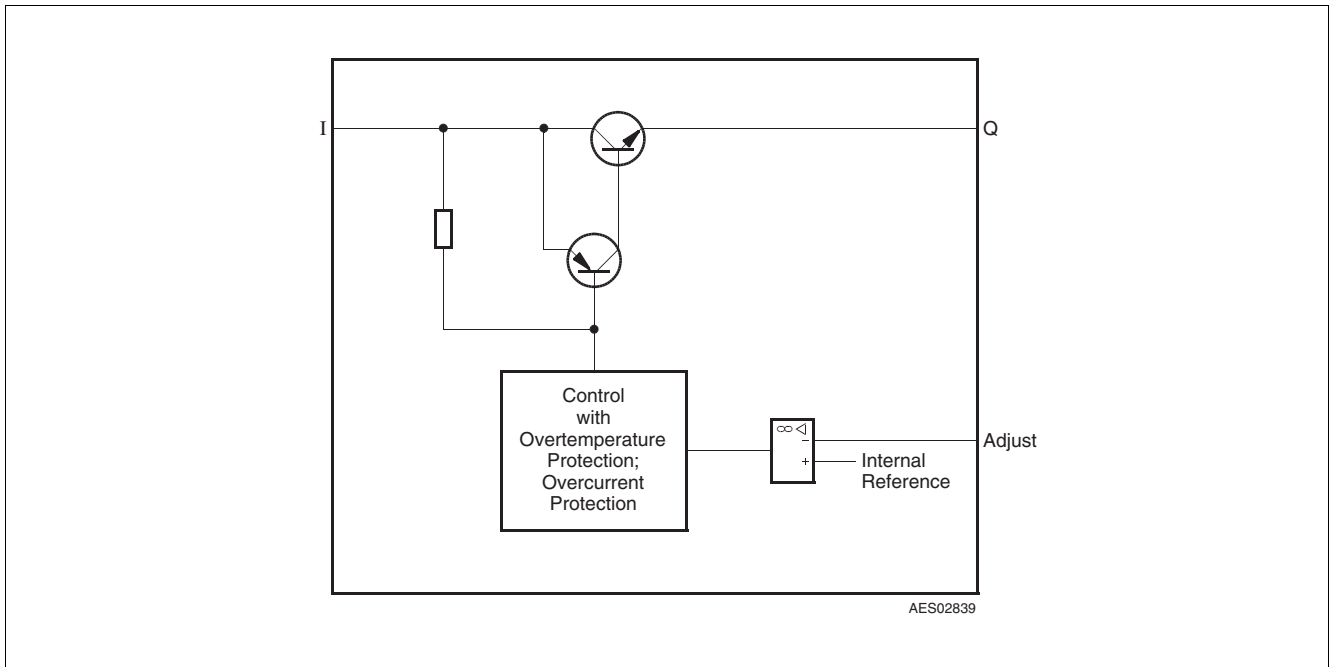

Figure 2 Block Diagram for Adjustable Output Voltage

3 Pin Configuration

3.1 Pin Assignment

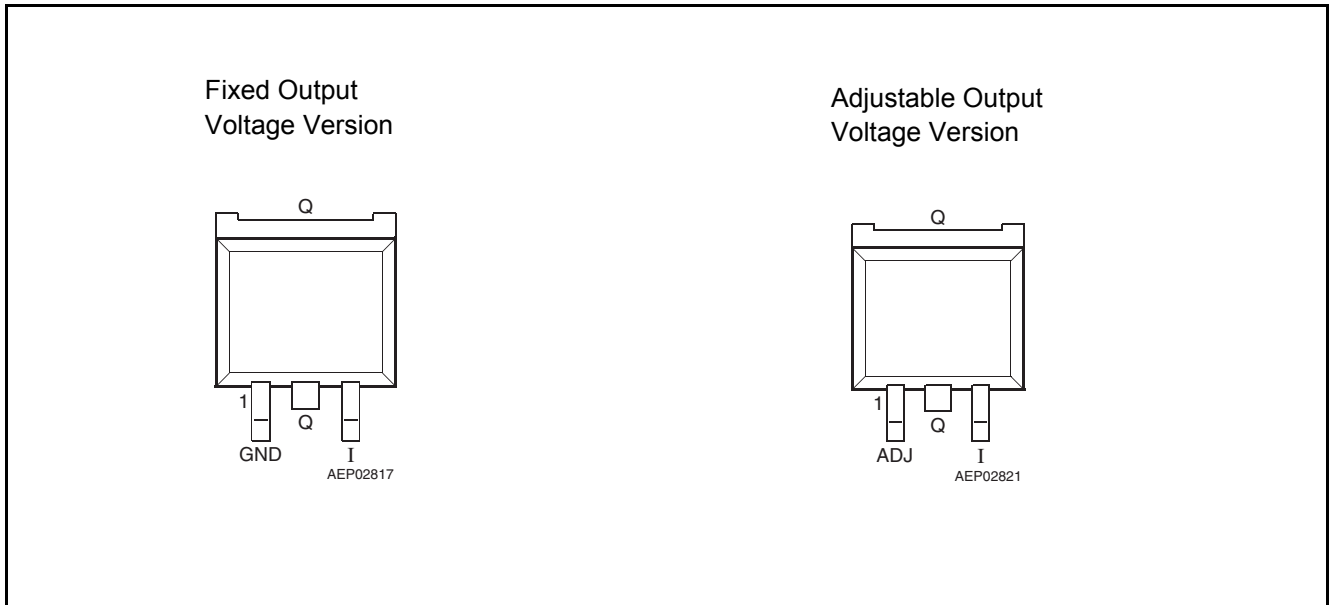

Figure 3 Pin Configuration (top view)

3.2 Pin Definitions and Functions

Table 1 Pin Definitions and Functions Fixed Output Voltage Versions

Pin No.	Symbol	Function
1	GND	Ground
2, Tab	Q	Output; Connect a capacitor $C_Q \geq 10 \mu\text{F}$ with $\text{ESR} \leq 10 \Omega$ between pin Q and GND Connect to heatsink area.
3	I	Input

Table 2 Pin Definitions and Functions Adjustable Output Version

Pin No.	Symbol	Function
1	ADJ	Adjust; defines output voltage by external voltage divider between Q, ADJ and GND.
2, Tab	Q	Output; the output voltage is defined by the external voltage divider between Q, Adjust and Ground. Connect a capacitor $C_Q \geq 10 \mu\text{F}$ with $\text{ESR} \leq 10 \Omega$ between pin Q and GND Connect to heatsink area.
3	I	Input

4 General Product Characteristics

4.1 Absolute Maximum Ratings

Absolute Maximum Ratings¹⁾

$T_j = -40\text{ °C}$ to 150 °C ; all voltages with respect to ground, (unless otherwise specified)

Pos.	Parameter	Symbol	Limit Values		Unit	Test Condition
			Min.	Max.		
Input I						
4.1.1	Voltage	V_I	-0.3	40	V	–
Input - Output Voltage Differential (Applies to Adjustable Output Version Only)						
4.1.2	Voltage	$V_I - V_Q$	-0.3	40	V	–
Output Q						
4.1.3	Voltage	V_Q	-0.3	40	V	–
Temperature						
4.1.4	Junction temperature	T_j	-40	150	°C	–
4.1.5	Storage temperature	T_{stg}	-50	150	°C	–
ESD Susceptibility						
4.1.6	ESD Absorption	$V_{ESD,HBM}$	-2	2	kV	Human Body Model (HBM) ²⁾
4.1.7		$V_{ESD,CDM}$	-500	500	V	Charge Device Model (CDM) ³⁾
4.1.8			-750	750	V	Charge Device Model (CDM) ³⁾ at corner pins

1) not subject to production test, specified by design

2) ESD susceptibility Human Body Model "HBM" according to AEC-Q100-002 - JESD22-A114

3) ESD susceptibility Charged Device Model "CDM" according to ESDA STM5.3.1

Note: Stresses above the ones listed here may cause permanent damage to the device. Exposure to absolute maximum rating conditions for extended periods may affect device reliability.

Note: Integrated protection functions are designed to prevent IC destruction under fault conditions described in the data sheet. Fault conditions are considered as "outside" normal operating range. Protection functions are not designed for continuous repetitive operation.

4.2 Functional Range

Pos.	Parameter	Symbol	Limit Values		Unit	Remarks
			Min.	Max.		
4.2.1	Input voltage	V_I	$V_I + V_{DR}$	40	V	
4.2.2	Junction temperature	T_j	-40	125	°C	–

Note: Within the functional or operating range, the IC operates as described in the circuit description. The electrical characteristics are specified within the conditions given in the Electrical Characteristics table.

4.3 Thermal Resistance

Note: This thermal data was generated in accordance with JEDEC JESD51 standards. For more information, go to www.jedec.org.

Pos.	Parameter	Symbol	Limit Values			Unit	Conditions
			Min.	Typ.	Max.		
PG-T0252-3							
4.3.1	Junction to Case ¹⁾	R_{thJC}	–	4	–	K/W	measured to heat slug
4.3.2	Junction to Ambient ¹⁾	R_{thJA}	–	27	–	K/W	²⁾
4.3.3		R_{thJA}	–	57	–	K/W	300 mm ² heatsink area ³⁾
4.3.4		R_{thJA}	–	42	–	K/W	600 mm ² heatsink area ³⁾

1) Not subject to production test, specified by design.

2) Specified R_{thJA} value is according to Jedec JESD51-2,-5,-7 at natural convection on FR4 2s2p board; The Product (Chip+Package) was simulated on a 76.2 x 114.3 x 1.5 mm³ board with 2 inner copper layers (2 x 70µm Cu, 2 x 35µm Cu). Where applicable a thermal via array under the exposed pad contacted the first inner copper layer.

3) Specified R_{thJA} value is according to Jedec JESD 51-3 at natural convection on FR4 1s0p board; The Product (Chip+Package) was simulated on a 76.2 x 114.3 x 1.5 mm³ board with 1 copper layer (1 x 70µm Cu).

5 Electrical Characteristics

5.1 Electrical Characteristics Voltage Regulator

Table 3 Electrical Characteristics IFX27001TFV DV (adjustable output voltage)
 $-40\text{ }^{\circ}\text{C} < T_j < 125\text{ }^{\circ}\text{C}$; $V_1 - V_Q = 13.5\text{ V}$, $I_Q = 10\text{ mA}$; unless otherwise specified

Parameter	Symbol	Limit Values			Unit	Measuring Conditions
		min.	typ.	max.		
Reference voltage	V_{REF} ¹⁾	1.20	1.25	1.30	V	–
Line regulation	ΔV_Q	–	0.5	1.50	% ²⁾	$3\text{ V} \leq (V_1 - V_Q) \leq 40\text{ V}$
Load regulation	ΔV_Q	–	0.2	0.4	% ²⁾	$10\text{ mA} \leq I_Q \leq 800\text{ mA}$; ⁴⁾ $V_1 = 3.0\text{ V}$; $V_Q = V_{REF}$
		–	0.25	0.5	% ²⁾	$10\text{ mA} \leq I_Q \leq 1.0\text{ A}$; ⁴⁾ $V_1 = 3.0\text{ V}$; $V_Q = V_{REF}$
Dropout voltage	V_{DR}	–	1.00	1.20	V	$I_Q = 100\text{ mA}$ ³⁾
		–	1.05	1.30	V	$I_Q = 500\text{ mA}$ ³⁾
		–	1.10	1.35	V	$I_Q = 800\text{ mA}$ ³⁾
		–	1.30	1.40	V	$I_Q = 1.0\text{ A}$ ³⁾
Current consumption $I_q = I_1 - I_Q$	I_q	–	100	120	μA	$I_Q = 10\text{ mA}$;
Adjust current	I_{ADJ}	–	75	120	μA	$I_Q = 10\text{ mA}$
Adjust current change	ΔI_{ADJ}	–	2	5	μA	$I_Q = 10\text{ mA}$ $3\text{ V} \leq (V_1 - V_Q) \leq 40\text{ V}$ ⁴⁾
		–	2	5	μA	$10\text{ mA} \leq I_Q \leq 200\text{ mA}$; $V_1 - V_Q = 3\text{ V}$ ⁴⁾
Temperature stability	–	–	0.6	–	%	⁵⁾
Minimum load current ⁶⁾	I_Q	–	1	5	mA	$V_1 < 40\text{ V}$; $V_Q = V_{REF}$
Current limit	I_{Qmax}	1000	–	2200	mA	$1.4\text{ V} < V_1 - V_Q < 18\text{ V}$; $V_Q = V_{nom} - 100\text{ mV}$
		50	200	–	mA	$V_1 = 40\text{ V}$; $V_Q = V_{nom} - 100\text{ mV}$ $T_j = 25\text{ }^{\circ}\text{C}$
RMS Output Noise	–	–	30	–	ppm	ppm of V_Q ; $T_j = 25\text{ }^{\circ}\text{C}$; $10\text{ Hz} \leq f \leq 10\text{ kHz}$ ⁵⁾
Power Supply Ripple Rejection	$PSRR$	–	65	–	dB	$V_Q = 10\text{ V}$, $f_r = 120\text{ Hz}$, $V_r = 0.5 V_{PP}$, $C_{ADJ} = 0\text{ }\mu\text{F}$ ⁵⁾
		–	65	–	dB	$V_Q = 10\text{ V}$, $f_r = 120\text{ Hz}$, $V_r = 0.5 V_{PP}$, $C_{ADJ} = 10\text{ }\mu\text{F}$ ⁵⁾

1) $V_{REF} = V_Q - V_{ADJ}$

2) Related to V_Q , measured at constant junction Temperature

3) Dropout voltage measured when the output voltage has dropped 100 mV from the nominal value obtained at $V_Q = V_{REF}$.

4) Constant Junction Temperature

5) Not subject to production test - specified by design.

6) Minimum Output Current to maintain regulation

Electrical Characteristics
Table 4 Electrical Characteristics IFX27001TFV15 DV15 (1.5 V fixed output voltage)
 $-40\text{ °C} < T_j < 125\text{ °C}$; $V_I = 13.5\text{ V}$, $I_Q = 10\text{ mA}$; unless otherwise specified

Parameter	Symbol	Limit Values			Unit	Measuring Conditions
		min.	typ.	max.		
Output voltage	V_Q	1.45	1.5	1.55	V	$10\text{ mA} \leq I_Q \leq 1000\text{ mA}$; $2.9\text{ V} \leq V_I \leq 16\text{ V}$
		–	1.5	–	V	$10\text{ mA} \leq I_Q \leq 1000\text{ mA}$; $16\text{ V} \leq V_I \leq 40\text{ V}$ ¹⁾
Line regulation	ΔV_Q	–	4.8	22.5	mV	$2.9\text{ V} \leq V_I \leq 40\text{ V}$
Load regulation	ΔV_Q	–	2.6	5.2	mV	$10\text{ mA} \leq I_Q \leq 800\text{ mA}$; ²⁾ $V_I = V_{Qnom} + V_{DR}$
		–	3.1	6.25	mV	$10\text{ mA} \leq I_Q \leq 1.0\text{ A}$ ²⁾ $V_I = V_{Qnom} + V_{DR}$
Dropout voltage	V_{DR}	–	1.00	1.20	V	$I_Q = 100\text{ mA}$ ³⁾
		–	1.05	1.30	V	$I_Q = 500\text{ mA}$ ³⁾
		–	1.10	1.35	V	$I_Q = 800\text{ mA}$ ³⁾
		–	1.30	1.40	V	$I_Q = 1.0\text{ A}$ ³⁾
Current consumption $I_q = I_I - I_Q$	I_q	–	0.8	1.6	mA	$I_Q = 10\text{ mA}$
Temperature stability	–	–	8.8	–	mV	⁴⁾
Current limit	I_{Qmax}	1000	–	2200	mA	$V_I - V_Q < 18\text{V}$; $V_Q = V_{nom} - 100\text{ mV}$
		50	200	–	mA	$V_I = 40\text{ V}$; $V_Q = V_{nom} - 100\text{ mV}$ $T_j = 25\text{ °C}$
RMS Output Noise	–	–	30	–	ppm	ppm of V_Q , $T_j = 25\text{ °C}$ $10\text{ Hz} \leq f \leq 10\text{ kHz}$ ⁴⁾
Power Supply Ripple Rejection	PSRR	–	65	–	dB	$f_r = 120\text{ Hz}$, $V_r = 0.5 V_{PP}$, $C_{ADJ} = 0\text{ }\mu\text{F}$ ⁴⁾
		–	65	–	dB	$f_r = 120\text{ Hz}$, $V_r = 0.5 V_{PP}$, $C_{ADJ} = 10\text{ }\mu\text{F}$ ⁴⁾

- 1) Device is usable within given range without destruction, but the accuracy of the output voltage can only be guaranteed in the range specified in the line above.
- 2) Measured at constant junction temperature
- 3) Dropout voltage measured when the output voltage has dropped 100 mV from the nominal value.
- 4) Not subject to production test - specified by design.

Electrical Characteristics
Table 5 Electrical Characteristics IFX27001TFV18 DV18 (1.8 V fixed output voltage)
 $-40\text{ °C} < T_j < 125\text{ °C}$; $V_I = 13.5\text{ V}$, $I_Q = 10\text{ mA}$; unless otherwise specified

Parameter	Symbol	Limit Values			Unit	Measuring Conditions
		min.	typ.	max.		
Output voltage	V_Q	1.75	1.8	1.85	V	$10\text{ mA} \leq I_Q \leq 1000\text{ mA}$; $3.2\text{ V} \leq V_I \leq 16\text{ V}$
		–	1.8	–	V	$10\text{ mA} \leq I_Q \leq 1000\text{ mA}$; $16\text{ V} \leq V_I \leq 40\text{ V}$ ¹⁾
Line regulation	ΔV_Q	–	7.2	27	mV	$3.2\text{ V} \leq V_I \leq 40\text{ V}$
Load regulation	ΔV_Q	–	3.4	7.6	mV	$10\text{ mA} \leq I_Q \leq 800\text{ mA}$ ²⁾ $V_I = V_{Qnom} + V_{DR}$
		–	4.8	9	mV	$10\text{ mA} \leq I_Q \leq 1.0\text{ A}$ ²⁾ $V_I = V_{Qnom} + V_{DR}$
Dropout voltage	V_{DR}	–	1.00	1.20	V	$I_Q = 100\text{ mA}$ ³⁾
		–	1.05	1.30	V	$I_Q = 500\text{ mA}$ ³⁾
		–	1.10	1.35	V	$I_Q = 800\text{ mA}$ ³⁾
		–	1.30	1.40	V	$I_Q = 1.0\text{ A}$ ³⁾
Current consumption $I_q = I_I - I_Q$	I_q	–	0.8	1.6	mA	$I_Q = 10\text{ mA}$
Temperature stability	–	–	11	–	mV	⁴⁾
Current limit	I_{Qmax}	1000	–	2200	mA	$V_I - V_Q < 18\text{ V}$; $V_Q = V_{nom} - 100\text{ mV}$
		50	200	–	mA	$V_I = 40\text{ V}$; $V_Q = V_{nom} - 100\text{ mV}$ $T_j = 25\text{ °C}$
RMS Output Noise	–	–	30	–	ppm	ppm of V_Q , $T_j = 25\text{ °C}$ $10\text{ Hz} \leq f \leq 10\text{ kHz}$ ⁴⁾
Power Supply Ripple Rejection	$PSRR$	–	65	–	dB	$f_r = 120\text{ Hz}$; $V_r = 0.5 V_{PP}$ $C_{ADJ} = 0\text{ }\mu\text{F}$ ⁴⁾
		–	65	–	dB	$f_r = 120\text{ Hz}$; $V_r = 0.5 V_{PP}$, $C_{ADJ} = 10\text{ }\mu\text{F}$ ⁴⁾

- 1) Device is usable within given range without destruction, but the accuracy of the output voltage can only be guaranteed in the range specified in the line above.
- 2) Measured at constant junction temperature
- 3) Dropout voltage measured when the output voltage has dropped 100 mV from the nominal value.
- 4) Not subject to production test - specified by design.

Electrical Characteristics
Table 6 Electrical Characteristics IFX27001TFV26 DV26 (2.6 V fixed output voltage)
 $-40\text{ °C} < T_j < 125\text{ °C}$; $V_I = 13.5\text{ V}$, $I_Q = 10\text{ mA}$; unless otherwise specified

Parameter	Symbol	Limit Values			Unit	Measuring Conditions
		min.	typ.	max.		
Output voltage	V_Q	2.52	2.60	2.68	V	$10\text{ mA} \leq I_Q \leq 1000\text{ mA}$; $4.0\text{ V} \leq V_I \leq 16\text{ V}$
		–	2.60	–	V	$10\text{ mA} \leq I_Q \leq 1000\text{ mA}$; $16\text{ V} \leq V_I \leq 40\text{ V}$ ¹⁾
Line regulation	ΔV_Q	–	11	40	mV	$4.0\text{ V} \leq V_I \leq 40\text{ V}$
Load regulation	ΔV_Q	–	5	11	mV	$10\text{ mA} \leq I_Q \leq 800\text{ mA}$; ²⁾ $V_I = V_{Qnom} + V_{DR}$
		–	7	13	mV	$10\text{ mA} \leq I_Q \leq 1.0\text{ A}$ ²⁾ $V_I = V_{Qnom} + V_{DR}$
Dropout voltage	V_{DR}	–	1.00	1.20	V	$I_Q = 100\text{ mA}$ ³⁾
		–	1.05	1.30	V	$I_Q = 500\text{ mA}$ ³⁾
		–	1.10	1.35	V	$I_Q = 800\text{ mA}$ ³⁾
		–	1.30	1.40	V	$I_Q = 1.0\text{ A}$ ³⁾
Current consumption; $I_q = I_I - I_Q$	I_q	–	0.8	1.6	mA	$I_Q = 10\text{ mA}$
Temperature stability	–	–	16	–	mV	⁴⁾
Current limit	I_{Qmax}	1000	–	2200	mA	$V_I - V_Q < 18\text{V}$; $V_Q = V_{nom} - 100\text{ mV}$
		50	200	–	mA	$V_I = 40\text{ V}$; $V_Q = V_{nom} - 100\text{ mV}$ $T_j = 25\text{ °C}$
RMS Output Noise	–	–	30	–	ppm	ppm of V_Q , $T_j = 25\text{ °C}$ $10\text{ Hz} \leq f \leq 10\text{ kHz}$ ⁴⁾
Power Supply Ripple Rejection	$PSRR$	–	65	–	dB	$f_r = 120\text{ Hz}$, $V_r = 0.5 V_{PP}$, $C_{ADJ} = 0\text{ }\mu\text{F}$ ⁴⁾
		–	65	–	dB	$f_r = 120\text{ Hz}$, $V_r = 0.5 V_{PP}$, $C_{ADJ} = 10\text{ }\mu\text{F}$ ⁴⁾

- 1) Device is usable within given range without destruction, but the accuracy of the output voltage can only be guaranteed in the range specified in the line above.
- 2) Measured at constant junction temperature
- 3) Dropout voltage measured when the output voltage has dropped 100 mV from the nominal value.
- 4) Not subject to production test - specified by design.

Electrical Characteristics

Table 7 Electrical Characteristics IFX27001TFV33 DV33 (3.3 V fixed output voltage)
 $-40\text{ °C} < T_j < 125\text{ °C}$; $V_I = 13.5\text{ V}$, $I_Q = 10\text{ mA}$; unless otherwise specified

Parameter	Symbol	Limit Values			Unit	Measuring Conditions
		Min.	Typ.	Max.		
Output voltage	V_Q	3.20	3.3	3.40	V	$10\text{ mA} \leq I_Q \leq 1000\text{ mA}$; $4.7\text{ V} \leq V_I \leq 16\text{ V}$
		–	3.3	–	V	$10\text{ mA} \leq I_Q \leq 1000\text{ mA}$; $16\text{ V} \leq V_I \leq 40\text{ V}$ ¹⁾
Line regulation	ΔV_Q	–	15	50	mV	$4.7\text{ V} \leq V_I \leq 40\text{ V}$
Load regulation	ΔV_Q	–	6	13	mV	$10\text{ mA} \leq I_Q \leq 800\text{ mA}$ ²⁾ $V_I = V_{Qnom} + V_{DR}$
		–	8	16	mV	$10\text{ mA} \leq I_Q \leq 1.0\text{ A}$ ²⁾ $V_I = V_{Qnom} + V_{DR}$
Dropout voltage	V_{DR}	–	1.00	1.20	V	$I_Q = 100\text{ mA}$ ³⁾
		–	1.05	1.30	V	$I_Q = 500\text{ mA}$ ³⁾
		–	1.10	1.35	V	$I_Q = 800\text{ mA}$ ³⁾
		–	1.30	1.40	V	$I_Q = 1.0\text{ A}$ ³⁾
Current consumption $I_q = I_I - I_Q$	I_q	–	0.8	1.6	mA	$I_Q = 10\text{ mA}$
Temperature stability	–	–	20	–	mV	⁴⁾
Current limit	I_{Qmax}	1000	–	2200	mA	$V_I - V_Q < 18\text{ V}$; $V_Q = V_{nom} - 100\text{ mV}$
		50	200	–	mA	$V_I = 40\text{ V}$; $V_Q = V_{nom} - 100\text{ mV}$ $T_j = 25\text{ °C}$
RMS Output Noise	–	–	30	–	ppm	ppm of V_Q ; $T_j = 25\text{ °C}$; $10\text{ Hz} \leq f \leq 10\text{ kHz}$ ⁴⁾
Power Supply Ripple Rejection	$PSRR$	–	65	–	dB	$f_r = 120\text{ Hz}$; $V_r = 0.5\text{ Vpp}$; $C_{ADJ} = 0\text{ }\mu\text{F}$ ⁴⁾
		–	65	–	dB	$f_r = 120\text{ Hz}$; $V_r = 0.5\text{ Vpp}$; $C_{ADJ} = 10\text{ }\mu\text{F}$ ⁴⁾

- 1) Device is usable within given range without destruction, but the accuracy of the output voltage can only be guaranteed in the range specified in the line above.
- 2) Measured at constant junction temperature.
- 3) Dropout voltage measured when the output voltage has dropped 100 mV from the nominal value.
- 4) Not subject to production test - specified by design.

Electrical Characteristics
Table 8 Electrical Characteristics IFX27001TFV50 DV50 (5.0 V fixed output voltage)
 $-40\text{ °C} < T_j < 125\text{ °C}; V_I = 13.5\text{ V}, I_Q = 10\text{ mA};$ unless otherwise specified

Parameter	Symbol	Limit Values			Unit	Measuring Conditions
		min.	typ.	max.		
Output voltage	V_Q	4.85	5.00	5.15	V	$10\text{ mA} \leq I_Q \leq 1000\text{ mA};$ $6.4\text{ V} \leq V_I \leq 16\text{ V}$
		–	5.00	–	V	$10\text{ mA} \leq I_Q \leq 1000\text{ mA};$ $16\text{ V} \leq V_I \leq 40\text{ V}$ ¹⁾
Line regulation	ΔV_Q	–	20	75	mV	$6.4\text{ V} \leq V_I \leq 40\text{ V}$
Load regulation	ΔV_Q	–	9	20	mV	$10\text{ mA} \leq I_Q \leq 800\text{ mA}$ ²⁾ $V_I = V_{Qnom} + V_{DR}$
		–	12	24	mV	$10\text{ mA} \leq I_Q \leq 1.0\text{ A}$ ²⁾ $V_I = V_{Qnom} + V_{DR}$
Dropout voltage	V_{DR}	–	1.00	1.20	V	$I_Q = 100\text{ mA}$ ³⁾
		–	1.05	1.30	V	$I_Q = 500\text{ mA}$ ³⁾
		–	1.10	1.35	V	$I_Q = 800\text{ mA}$ ³⁾
		–	1.30	1.40	V	$I_Q = 1.0\text{ A}$ ³⁾
Current consumption $I_q = I_I - I_Q$	I_q	–	0.8	1.6	mA	$I_Q = 10\text{ mA}$
Temperature stability	–	–	30	–	mV	⁴⁾
Current limit	I_{Qmax}	1000	–	2200	mA	$V_I - V_Q < 18\text{ V};$ $V_Q = V_{nom} - 100\text{ mV}$
		50	200	–	mA	$V_I = 40\text{ V};$ $V_Q = V_{nom} - 100\text{ mV}$ $T_j = 25\text{ °C}$
RMS Output Noise	–	–	30	–	ppm	ppm of $V_Q, T_j = 25\text{ °C}$ $10\text{ Hz} \leq f \leq 10\text{ kHz}$ ⁴⁾
Power Supply Ripple Rejection	$PSRR$	–	65	–	dB	$f_r = 120\text{ Hz}, V_r = 0.5 V_{PP},$ $C_{ADJ} = 0\text{ }\mu\text{F}$ ⁴⁾
		–	65	–	dB	$f_r = 120\text{ Hz}, V_r = 0.5 V_{PP},$ $C_{ADJ} = 10\text{ }\mu\text{F}$ ⁴⁾

- 1) Device is usable within given range without destruction, but the accuracy of the output voltage can only be guaranteed in the range specified in the line above.
- 2) Measured at constant junction temperature
- 3) Dropout voltage measured when the output voltage has dropped 100 mV from the nominal value.
- 4) Not subject to production test - specified by design.

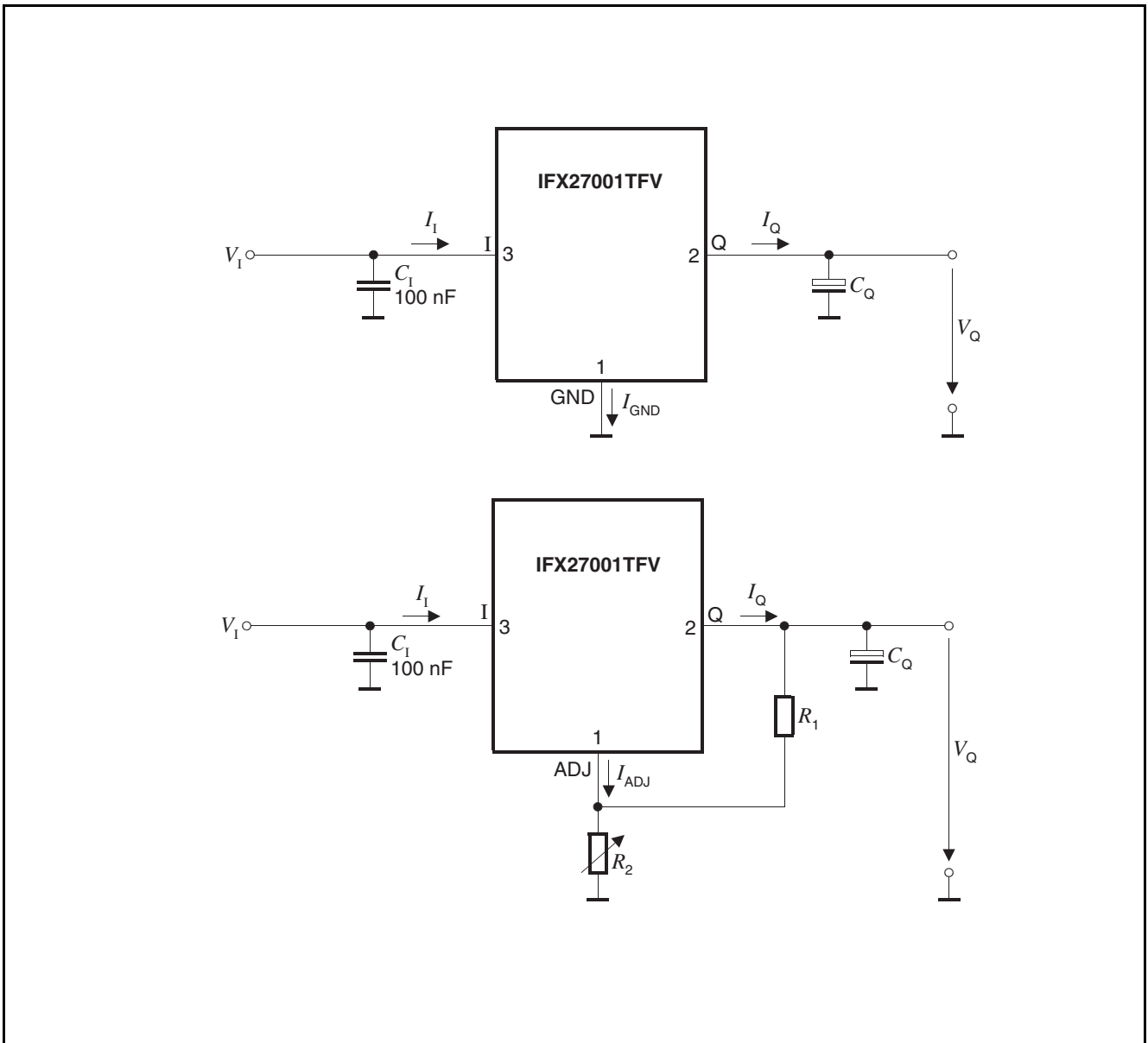
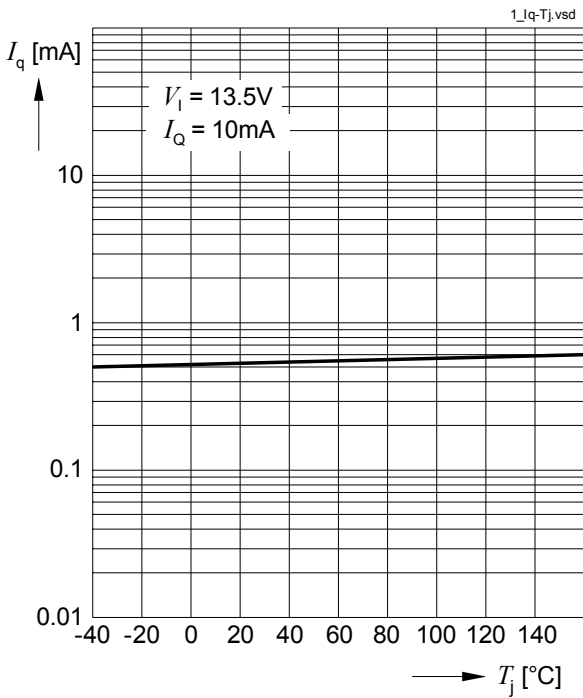

Figure 4 Measuring Circuit of fixed output voltage versions and adjustable output voltage version

5.2 Typical Performance Characteristics Voltage Regulator

Current Consumption I_q versus Junction Temperature T_j



Current Consumption I_q versus Input Voltage V_i

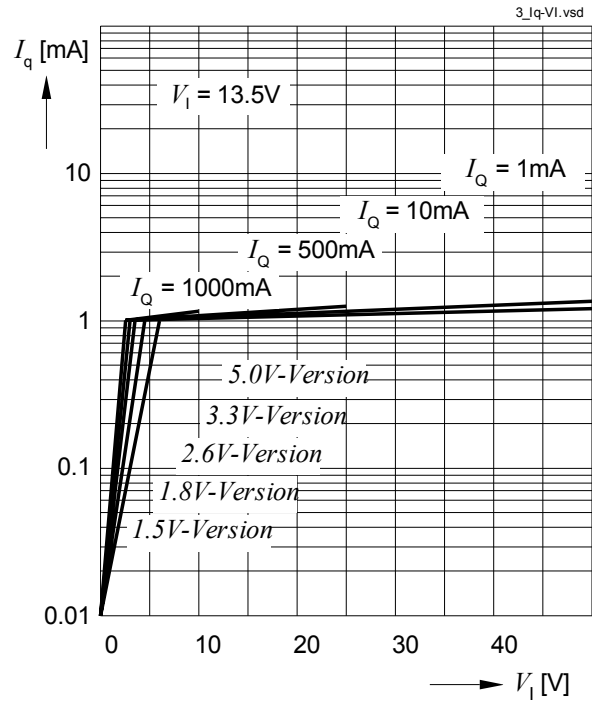

Current Consumption I_q versus Output Current I_Q

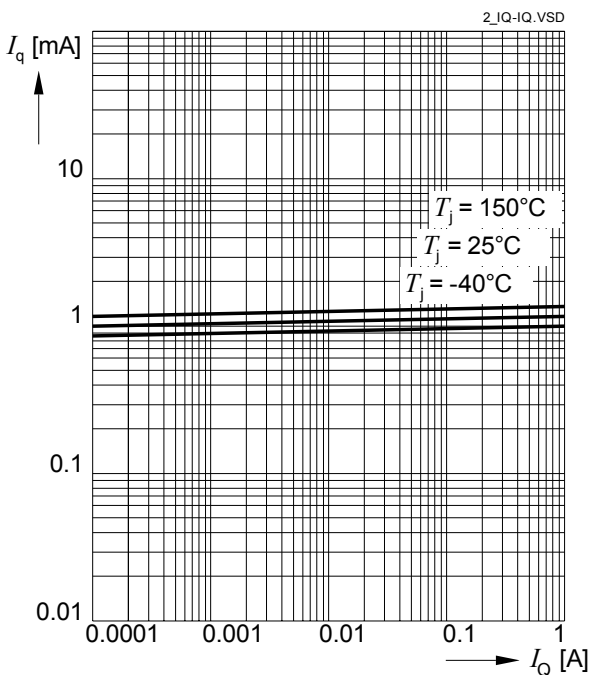

Adjust Current I_{ADJ} and Reference Voltage V_{REF} versus Junction Temperature T_j

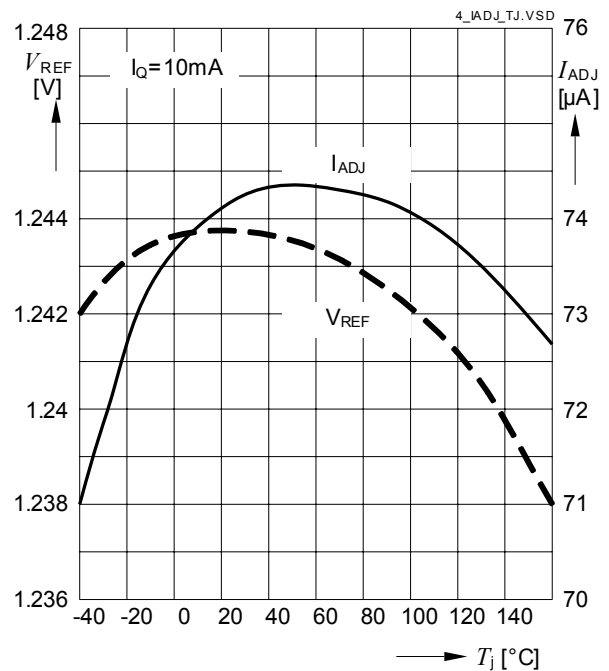

Output Voltage V_Q versus Input Voltage V_I

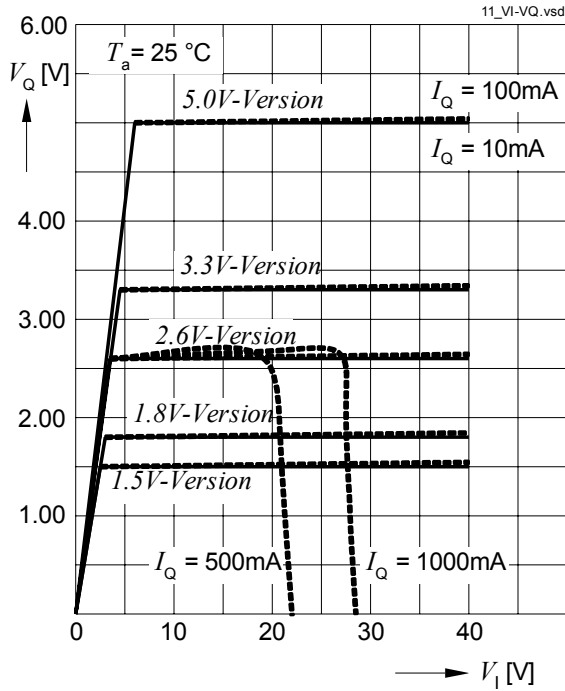

Power Supply Ripple Rejection versus Frequency

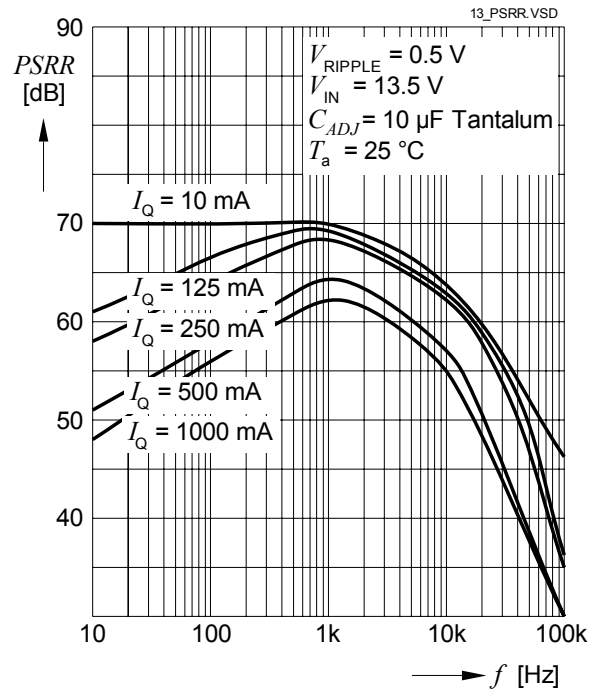

Stability Region: Equivalent Serial Resistor ESR versus Output Current I_Q

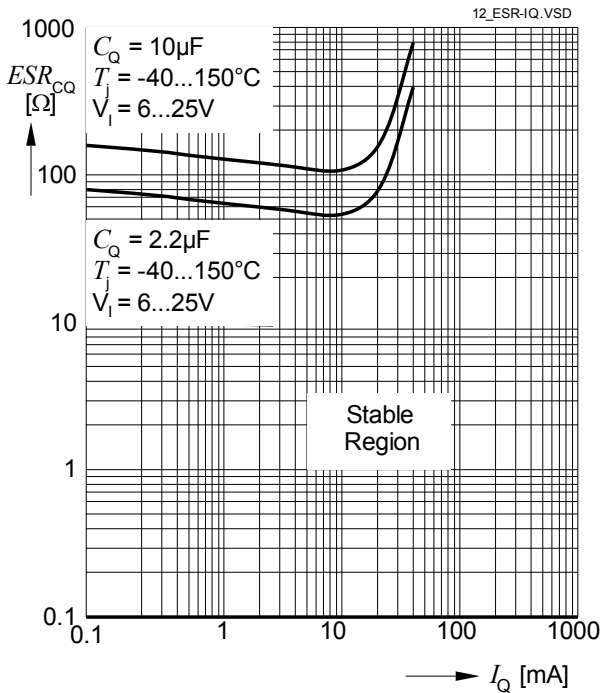

Power Supply Ripple Rejection versus Frequency

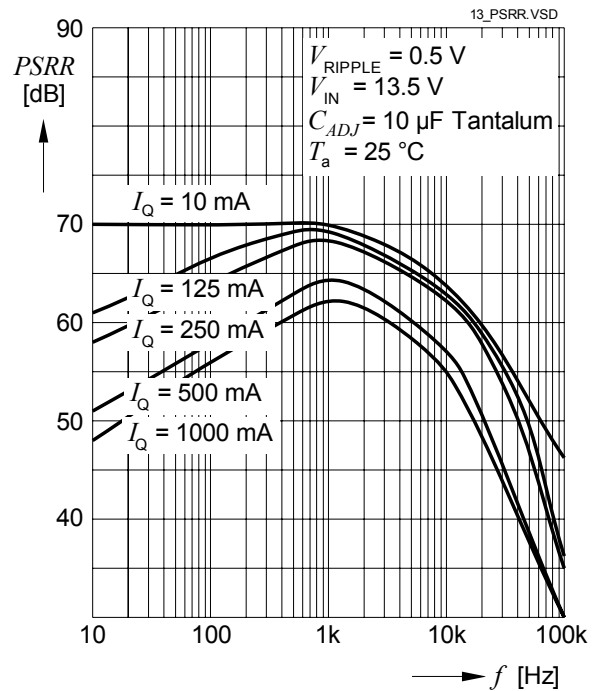

6 Application Information

Note: The following information is given as a hint for the implementation of the device only and shall not be regarded as a description or warranty of a certain functionality, condition or quality of the device.

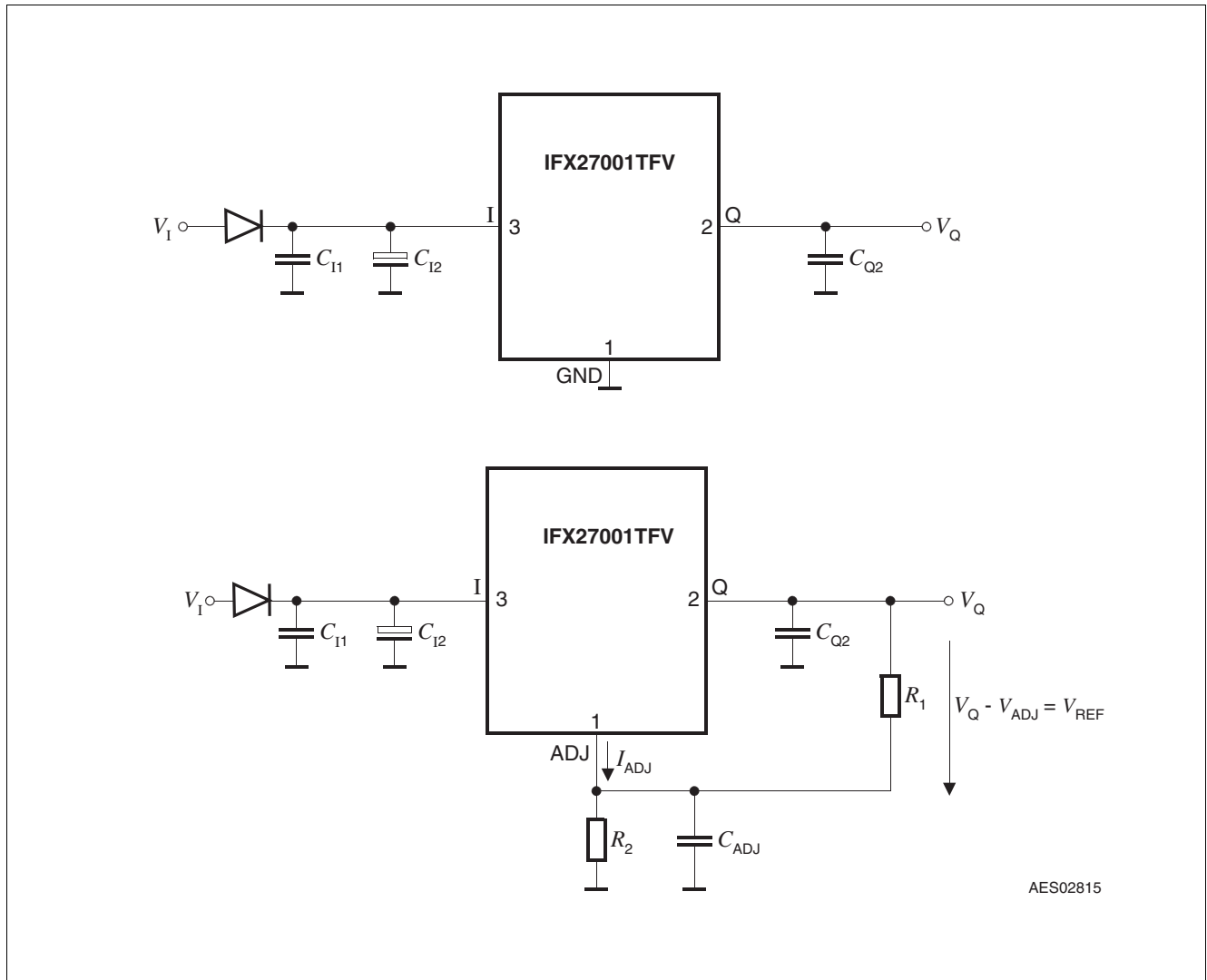

Figure 5 Application Diagram

Application Hints

Adjustable Version

At the fixed voltage IFX27001 devices, the output voltage is divided internally and compared to an internal reference of 1.25 V typical. The regulation loop controls the output voltage to achieve the output voltage of 5 V, 3.3 V, 2.6 V, 1.8V or 1.5V. The variable version compares the voltage difference between the adjust pin ADJ and the output pin Q to the internal reference of typically 1.25 V. The output voltage is adjusted by an external voltage divider between Q, ADJ and GND and calculates:

$$V_Q = V_{REF} \times \left(1 + \frac{R_2}{R_1}\right) + I_{ADJ} \times R_2$$

For the variable regulator IFX27001TFV, a minimum load current of 5 mA is necessary in order to keep the output voltage regulated. If the application does not assure this minimum load requirement, the output voltage divider should be dimensioned sufficiently low-ohmic: $R_1 \leq 240 \Omega$.

For the variable voltage type an additional decoupling capacitor C_{ADJ} at the adjust pin improves the ripple rejection ratios. Placing C_{ADJ} requires an increased output capacitance of $C_Q \geq 22 \mu\text{F}$.

Output

The output current limitation is reduced as a function of the input voltage for high input voltages above 25 V.

The IFX27001 requires a 10 μF output capacitor with $0.1 \Omega \leq \text{ESR} \leq 10 \Omega$ for the stability of the regulation loop.

At the input of the regulator a capacitor is necessary for compensation of line influences. A series diode should be used to eliminate negative voltages from the input. As a minimum, a 100 nF ceramic input capacitor should be used. If the regulator is used in an environment with long input lines, an input capacitance of 10 μF is recommended.

7 Package Outlines

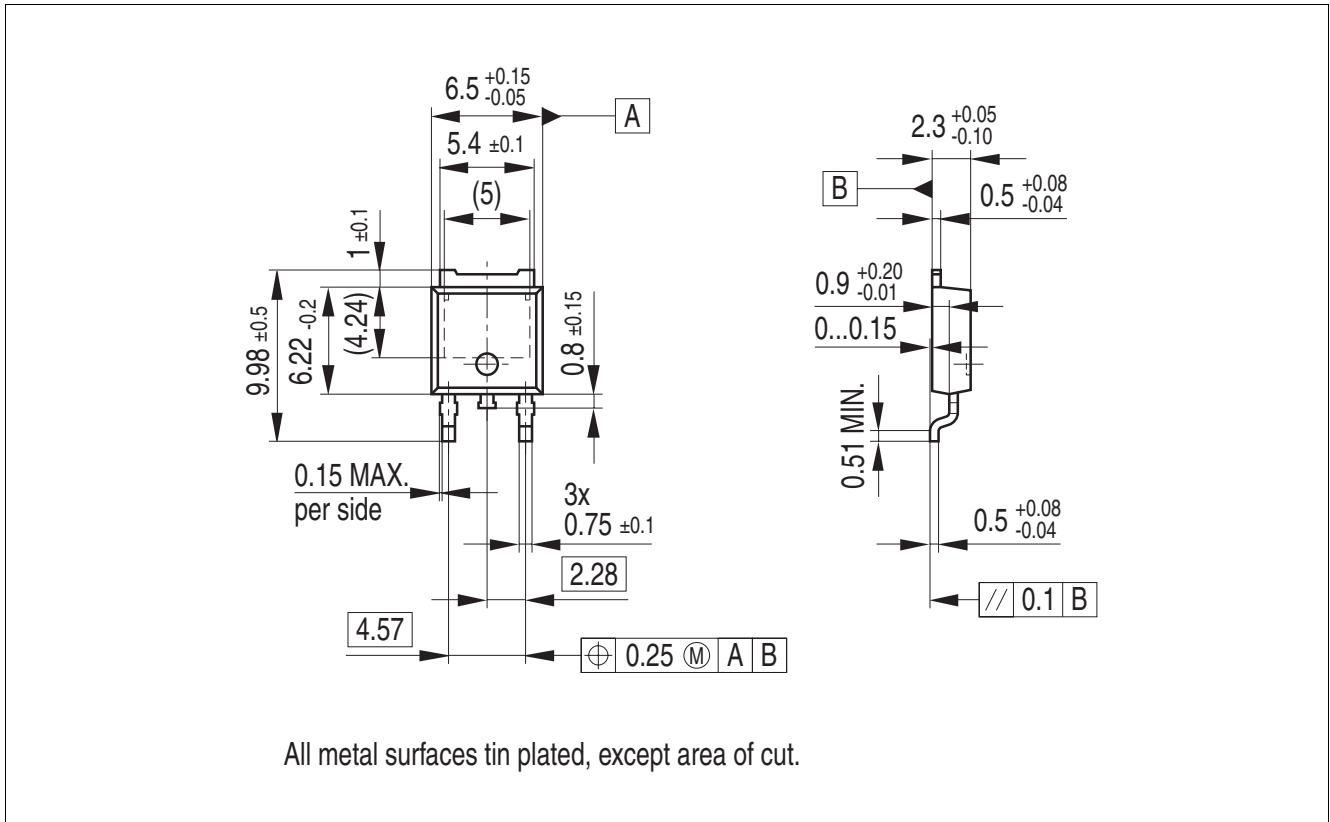

Figure 6 PG-T0252-3

Green Product (RoHS compliant)

To meet the world-wide customer requirements for environmentally friendly products and to be compliant with government regulations the device is available as a green product. Green products are RoHS-Compliant (i.e. Pb-free finish on leads and suitable for Pb-free soldering according to IPC/JEDEC J-STD-020).

For further information on packages, please visit our website:
<http://www.infineon.com/packages>.

Dimensions in mm

8 Revision History

Revision	Date	Changes
1.01	2009-10-19	Coverpage changed Overview page: Inserted reference statement to TLE/TLF series.
1.0	2009-04-28	Initial Release

Edition 2009-10-19

**Published by
Infineon Technologies AG
81726 Munich, Germany**

**© 2009 Infineon Technologies AG
All Rights Reserved.**

Legal Disclaimer

The information given in this document shall in no event be regarded as a guarantee of conditions or characteristics. With respect to any examples or hints given herein, any typical values stated herein and/or any information regarding the application of the device, Infineon Technologies hereby disclaims any and all warranties and liabilities of any kind, including without limitation, warranties of non-infringement of intellectual property rights of any third party.

Information

For further information on technology, delivery terms and conditions and prices, please contact the nearest Infineon Technologies Office (www.infineon.com).



Warnings

Due to technical requirements, components may contain dangerous substances. For information on the types in question, please contact the nearest Infineon Technologies Office.

Infineon Technologies components may be used in life-support devices or systems only with the express written approval of Infineon Technologies, if a failure of such components can reasonably be expected to cause the failure of that life-support device or system or to affect the safety or effectiveness of that device or system. Life support devices or systems are intended to be implanted in the human body or to support and/or maintain and sustain and/or protect human life. If they fail, it is reasonable to assume that the health of the user or other persons may be endangered.

Looking for pricing, stock, or lifecycle information?

Click below to explore more details on WIN SOURCE:

-  [View IFX27001TFV33ATMA1 on WIN SOURCE](#)
-  [Infineon Technologies Information](#)

Optimize Your Supply Chain with WIN SOURCE Solutions

-  Global Sourcing Solution
-  Obsolete Management
-  Cost Control Management
-  Shortage Management
-  Alternative Solution
-  Excess Inventory Management