



**THE DATASHEET OF
LM2940-50CKCSE3**



FEATURES

- Dropout Voltage 0.385 V (Typ) at $I_O = 1$ A
- Output Current in Excess of 1 A
- Output Voltage Trimmed Before Assembly
- Reverse-Battery Protection
- Internal Short-Circuit Current Limit
- Mirror-Image Insertion Protection
- Available in
 - Commercial Temperature (0°C to 125°C)
 - Extended Temperature (–40°C to 125°C)

DESCRIPTION/ORDERING INFORMATION

The LM2940 positive-voltage regulator features the ability to source 1 A of output current, with a typical dropout voltage of 0.385 V and a maximum of 800 mV over the entire temperature range. Furthermore, a quiescent current reduction circuit has been included, which reduces the ground current when the differential between the input voltage and the output voltage exceeds approximately 3 V. The quiescent current with 1 A of output current and an input-output differential of 5 V is, therefore, only 30 mA. Higher quiescent currents only exist when the regulator is in the dropout mode ($V_I - V_O \leq 3$ V).

Also designed for vehicular applications, the LM2940 and all regulated circuitry are protected from reverse battery installations or two-battery jumps. During line transients, such as load dump when the input voltage can momentarily exceed the specified maximum operating voltage, the regulator automatically shuts down to protect both the internal circuits and the load. The LM2940 is not harmed by temporary mirror-image insertion. Familiar regulator features, such as short-circuit and thermal-overload protection, also are provided.

DCY (SOT-223) PACKAGE
(TOP VIEW)

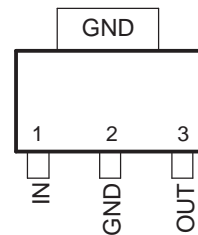

KTT (TO-263) PACKAGE
(TOP VIEW)

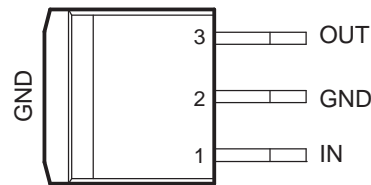

KCS (TO-220) PACKAGE
(TOP VIEW)

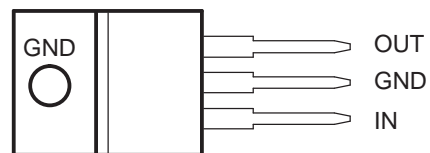

Please be aware that an important notice concerning availability, standard warranty, and use in critical applications of Texas Instruments semiconductor products and disclaimers thereto appears at the end of this data sheet.

LM2940 1-A LOW-DROPOUT VOLTAGE REGULATOR

SLVS634–MAY 2006

ORDERING INFORMATION

T _A	V _Z	PACKAGE ⁽¹⁾		ORDERABLE PART NUMBER	TOP-SIDE MARKING
0°C to 125°C	5 V	SOT-223 (DCY)	Reel of 2500	LM2940-50CDCYR	PREVIEW
		TO-220 (KCS)	Tube of 50	LM2940-50CKCSE3	LM2940-50C
		TO-263 (KTT)	Reel of 1000	LM2940-50CKTTR	PREVIEW
	8 V	SOT-223 (DCY)	Reel of 2500	LM2940-80CDCYR	PREVIEW
		TO-220 (KCS)	Tube of 50	LM2940-80CKCS	PREVIEW
		TO-263 (KTT)	Reel of 1000	LM2940-80CKTTR	PREVIEW
	12 V	SOT-223 (DCY)	Reel of 2500	LM2940-120CDCYR	PREVIEW
		TO-220 (KCS)	Tube of 50	LM2940-120CKCS	PREVIEW
		TO-263 (KTT)	Reel of 1000	LM2940-120CKTTR	PREVIEW
-40°C to 125°C	5 V	SOT-223 (DCY)	Reel of 2500	LM2940-50IDCYR	PREVIEW
		TO-220 (KCS)	Tube of 50	LM2940-50IKCSE3	LM2940-50I
		TO-263 (KTT)	Reel of 1000	LM2940-50IKTTR	PREVIEW
	8 V	SOT-223 (DCY)	Reel of 2500	LM2940-80IDCYR	PREVIEW
		TO-220 (KCS)	Tube of 50	LM2940-80IKCS	PREVIEW
		TO-263 (KTT)	Reel of 1000	LM2940-80IKTTR	PREVIEW
	12 V	SOT-223 (DCY)	Reel of 2500	LM2940-120IDCYR	PREVIEW
		TO-220 (KCS)	Tube of 50	LM2940-120IKCS	PREVIEW
		TO-263 (KTT)	Reel of 1000	LM2940-120IKTTR	PREVIEW

(1) Package drawings, standard packing quantities, thermal data, symbolization, and PCB design guidelines are available at www.ti.com/sc/package.

SIMPLIFIED SCHEMATIC

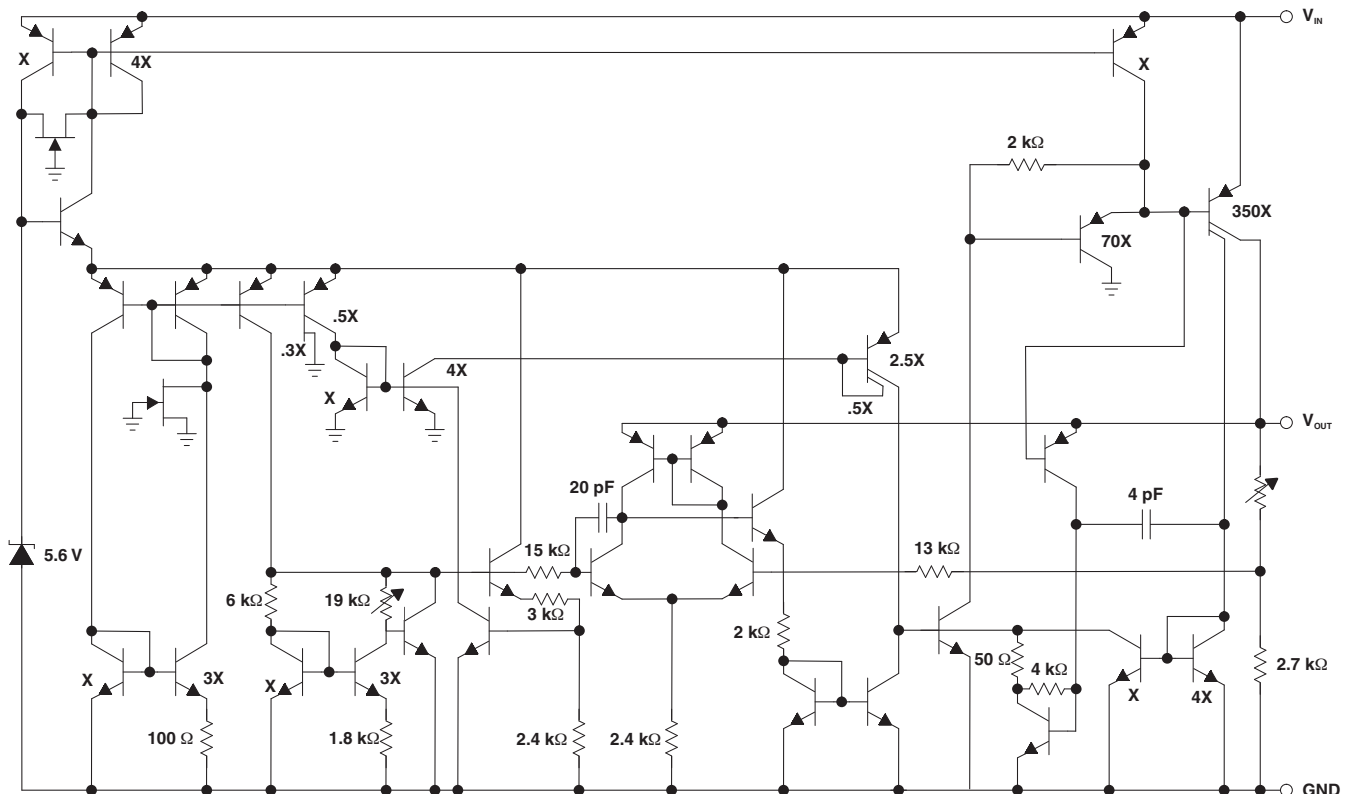

Absolute Maximum Ratings⁽¹⁾

over free-air temperature range (unless otherwise noted)

			MIN	MAX	UNIT
V _I	Input voltage range ⁽²⁾		–0.3	45	V
θ _{JA}	Package thermal impedance ⁽³⁾⁽⁴⁾	DCY package		52.8	°C/W
		KCS package		24.8	
		KTT package		25.3	
T _J	Operating virtual junction temperature			150	°C
T _{stg}	Storage temperature range		–65	150	°C
T _L	Maximum lead temperature, time for wave soldering	DCY package	4 s	260	°C
		KCS package	10 s	260	
		KTT package	4 s	245	

- (1) Stresses beyond those listed under *Absolute Maximum Ratings* may cause permanent damage to the device. These are stress ratings only, and functional operation of the device at these or any other conditions beyond those indicated under *Recommended Operating Conditions* is not implied. Exposure to absolute-maximum-rated conditions for extended periods may affect device reliability.
- (2) If load is returned to a negative power supply, the output must be diode clamped to GND.
- (3) Maximum power dissipation is a function of T_{J(max)}, θ_{JA}, and T_A. The maximum allowable power dissipation at any allowable ambient temperature is P_D = (T_{J(max)} – T_A)/θ_{JA}. Operating at the absolute maximum T_J of 150°C can affect reliability.
- (4) The package thermal impedance is calculated in accordance with JESD 51-7.

Recommended Operating Conditions

			MIN	MAX	UNIT
V _I	Input voltage			26	V
T _A	Free-air temperature range	Commercial temperature	0	125	°C
		Extended temperature	–40	125	

LM2940

1-A LOW-DROPOUT VOLTAGE REGULATOR

SLVS634–MAY 2006

LM2940x Electrical Characteristics

$V_I = V_O + 5\text{ V}$, $I_O = 1\text{ A}$, $C_O = 22\text{ }\mu\text{F}$ (unless otherwise noted)

PARAMETER	TEST CONDITIONS		$T_A^{(1)}$	5 V			8 V			UNIT	
				MIN	TYP	MAX	MIN	TYP	MAX		
V_O Output voltage	5 mA $\leq I_O \leq 1\text{ A}$, 5 V: 6.25 V $\leq V_I \leq 26\text{ V}$, 8 V: 9.4 V $\leq V_I \leq 26\text{ V}$		25°C	4.85	5	5.15	7.76	8	8.24	V	
			Full range	4.75		5.25	7.6		8.4		
Line regulation	$V_O + 2\text{ V} \leq V_I \leq 26\text{ V}$, $I_O = 5\text{ mA}$		25°C		20	50		20	80	mV	
Load regulation	50 mA $\leq I_O \leq 1\text{ A}$	LM2940I	25°C		35	50		55	80	mV	
		LM2940C	Full range			80			130		
Z_O Output impedance	100 mA _{dc} , 20 mA _{rms} , $f_O = 120\text{ Hz}$		25°C		35			55		m Ω	
I_Q Quiescent current	$V_O + 2\text{ V} \leq V_I \leq 26\text{ V}$, $I_O = 5\text{ mA}$	LM2940I	25°C		10	15		10	15	mA	
		LM2940C	Full range			20			20		
	$V_I = V_O + 5\text{ V}$, $I_O = 1\text{ A}$	LM2940I	25°C		10	15		10	15		
		LM2940C	Full range		30	45		30	45		
V_n Output noise voltage	$f_O = 10\text{ Hz}$ to 100 kHz, $I_O = 5\text{ mA}$		25°C		150			240		μV_{rms}	
Ripple rejection	$f_O = 120\text{ Hz}$, 1 V_{rms} , $I_O = 100\text{ mA}$	LM2940I	25°C	60	72		54	66		dB	
		LM2940C	Full range	54			48				
Long-term stability			25°C		20			32		mV/ 1000 h	
$V_I - V_O$ Dropout voltage	$I_O = 1\text{ A}$			25°C		385	500		385	500	mV
				Full range			800			800	
	$I_O = 500\text{ mA}$			25°C		250	300				
				Full range			600				
	$I_O = 100\text{ mA}$			25°C					110	150	
				Full range						200	
$I_{O(\text{MAX})}$ Short-circuit current			25°C	1.6	1.9		1.6	1.9		A	
Maximum line transient	$R_O = 100\text{ }\Omega$, $t \leq 100\text{ ms}$	LM2940I	25°C	60	75		60	75		V	
		LM2940C	Full range	60			60				
Reverse polarity dc input voltage	$R_O = 100\text{ }\Omega$	LM2940I	25°C	-15	-30		-15	-30		V	
		LM2940C	Full range	-15			-15				
Reverse polarity transient input voltage	$R_O = 100\text{ }\Omega$, $t \leq 100\text{ ms}$	LM2940I	25°C	-50	-75		-50	-75		V	
		LM2940C	Full range	-50			-50				
	$R_O = 100\text{ }\Omega$, $t \leq 1\text{ ms}$	LM2940I	25°C	-45	-55		-50	-50			
		LM2940C	Full range	-45			-50				

(1) Full range T_A is -40°C to 125°C for the LM2940I and 0°C to 125°C for the LM2940C.

LM2940x Electrical Characteristics

$V_I = V_O + 5\text{ V}$, $I_O = 1\text{ A}$, $C_O = 22\text{ }\mu\text{F}$ (unless otherwise noted)

PARAMETER	TEST CONDITIONS		$T_A^{(1)}$	12 V			UNIT
				MIN	TYP	MAX	
V_O Output voltage	5 mA $\leq I_O \leq 1\text{ A}$, 9 V: 10.5 V $\leq V_I \leq 26\text{ V}$, 12 V: 13.6 V $\leq V_I \leq 26\text{ V}$		25°C	11.64	12	12.36	V
			Full range	11.4		12.6	
Line regulation	$V_O + 2\text{ V} \leq V_I \leq 26\text{ V}$, $I_O = 5\text{ mA}$		25°C		20	120	mV
Load regulation	50 mA $\leq I_O \leq 1\text{ A}$	LM2940I	25°C		55	120	mV
		LM2940C	Full range			200	
Z_O Output impedance	100 mA _{dc} , 20 mA _{rms} , $f_O = 120\text{ Hz}$		25°C		80		m Ω
I_Q Quiescent current	$V_O + 2\text{ V} \leq V_I \leq 26\text{ V}$, $I_O = 5\text{ mA}$	LM2940I	25°C		10	15	mA
		LM2940C	Full range			20	
	$V_I = V_O + 5\text{ V}$, $I_O = 1\text{ A}$	LM2940I	25°C		10	15	
		LM2940C	Full range			30	
V_n Output noise voltage	$f_O = 10\text{ Hz to }100\text{ kHz}$, $I_O = 5\text{ mA}$		25°C		360		μV_{rms}
Ripple rejection	$f_O = 120\text{ Hz}$, 1 V _{rms} , $I_O = 100\text{ mA}$	LM2940I	25°C	54	66		dB
		LM2940C	Full range	48			
Long-term stability			25°C		48		mV/ 1000 h
$V_I - V_O$ Dropout voltage	$I_O = 1\text{ A}$			25°C	400	500	mV
				Full range	800		
	$I_O = 100\text{ mA}$			25°C	110	150	
				Full range	200		
$I_{O(\text{MAX})}$ Short-circuit current			25°C	1.6	1.9		A
Maximum line transient	$R_O = 100\text{ }\Omega$, $t \leq 100\text{ ms}$	LM2940I	25°C	60	75		V
	$R_O = 100\text{ }\Omega$, $t \leq 1\text{ ms}$	LM2940C	Full range	60			
Reverse polarity dc input voltage	$R_O = 100\text{ }\Omega$	LM2940I	25°C	-15	-30		V
		LM2940C	Full range	-15			
Reverse polarity transient input voltage	$R_O = 100\text{ }\Omega$, $t \leq 100\text{ ms}$	LM2940I	25°C	-50	-75		V
		LM2940C	Full range	-50			
	$R_O = 100\text{ }\Omega$, $t \leq 1\text{ ms}$	LM2940I	25°C	-45	-55		
		LM2940C	Full range	-45			

(1) Full range T_A is -40°C to 125°C for the LM2940I and 0°C to 125°C for the LM2940C.

TYPICAL CHARACTERISTICS

DROPOUT VOLTAGE
VS
OUTPUT CURRENT

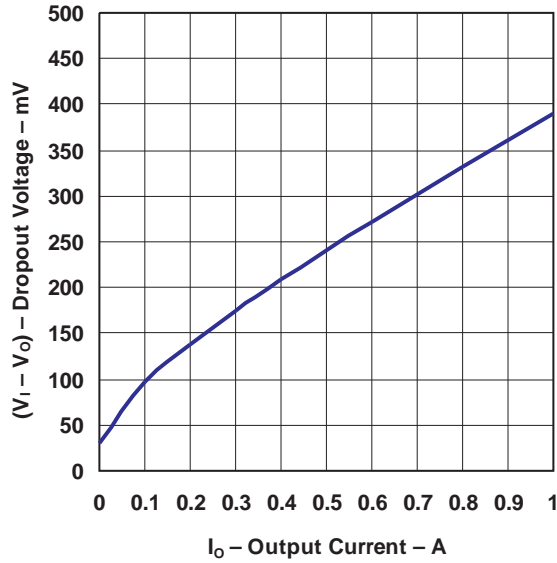

DROPOUT VOLTAGE
VS
TEMPERATURE

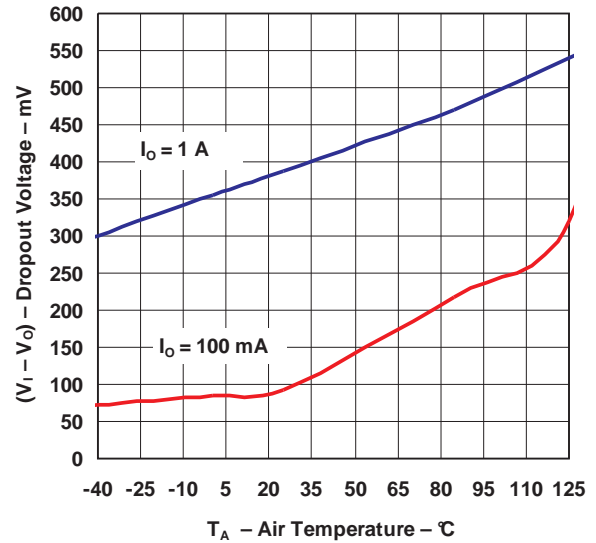

OUTPUT VOLTAGE
VS
TEMPERATURE

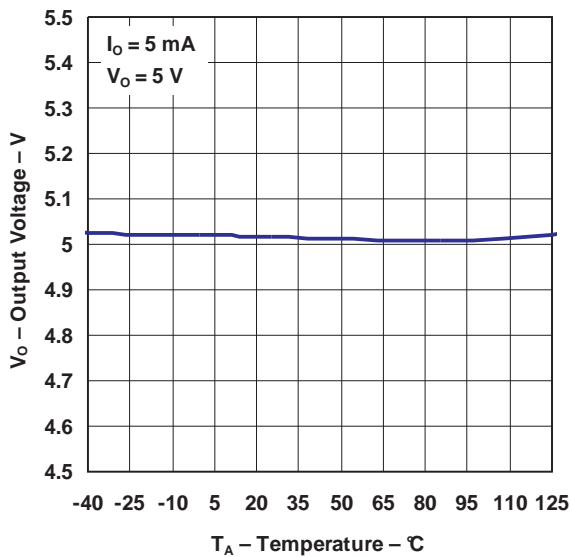

QUIESCENT CURRENT
VS
TEMPERATURE

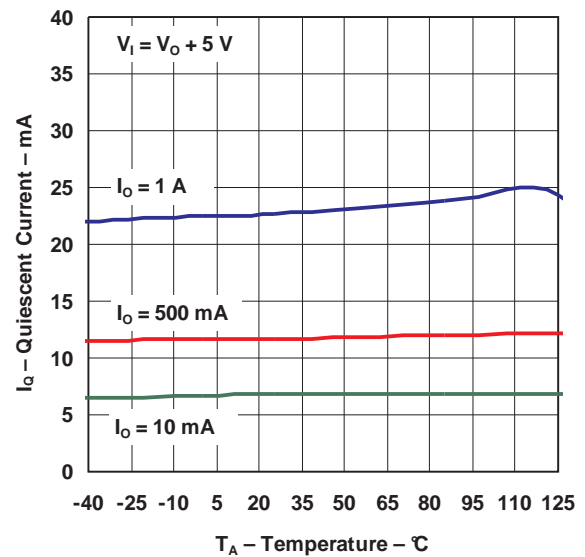

TYPICAL CHARACTERISTICS (continued)

**QUIESCENT CURRENT
VS
INPUT VOLTAGE**

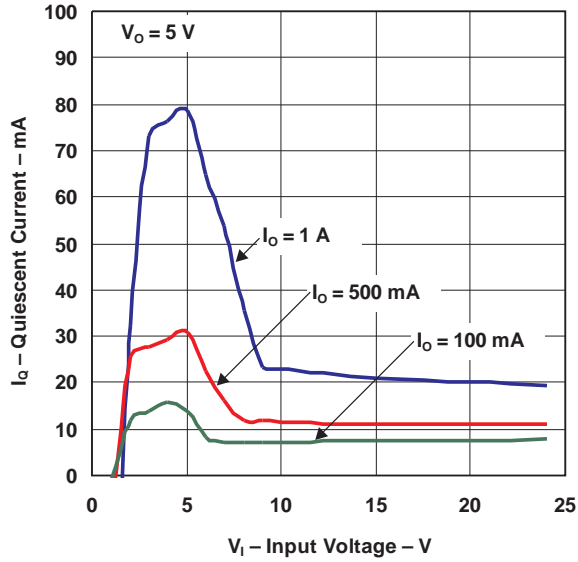

**QUIESCENT CURRENT
VS
LOAD CURRENT**

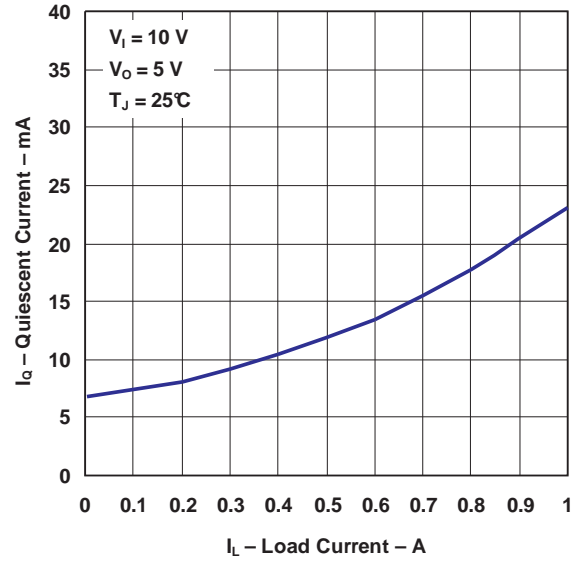

LINE TRANSIENT RESPONSE

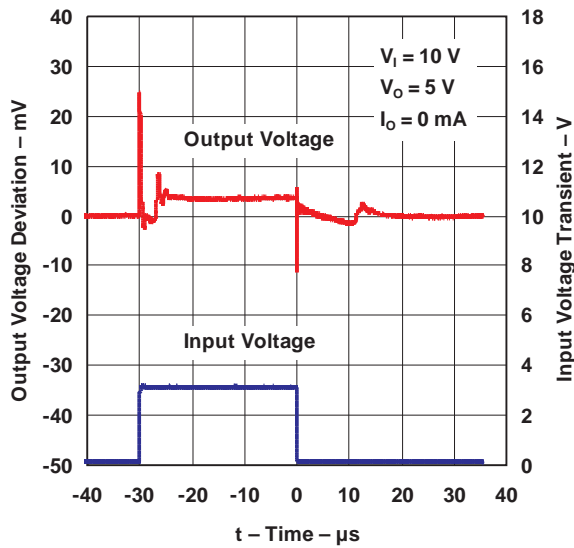

LOAD TRANSIENT RESPONSE

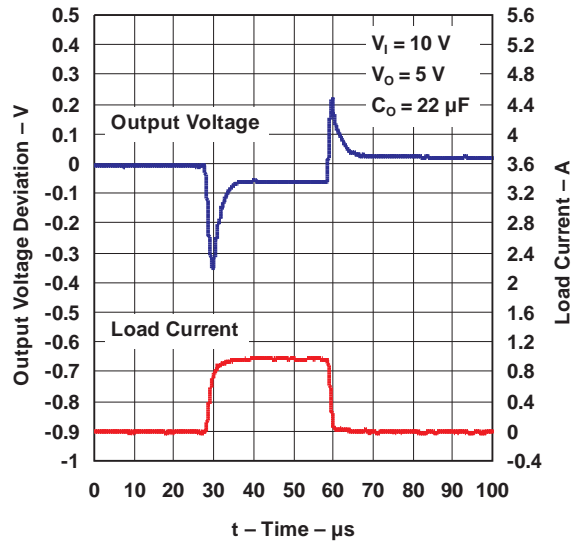

TYPICAL CHARACTERISTICS (continued)

RIPPLE REJECTION
VS
FREQUENCY

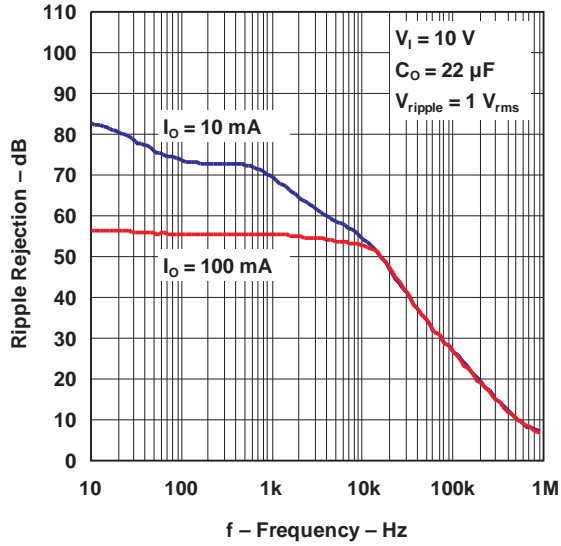

LOW-VOLTAGE BEHAVIOR
OUTPUT VOLTAGE
VS
INPUT VOLTAGE

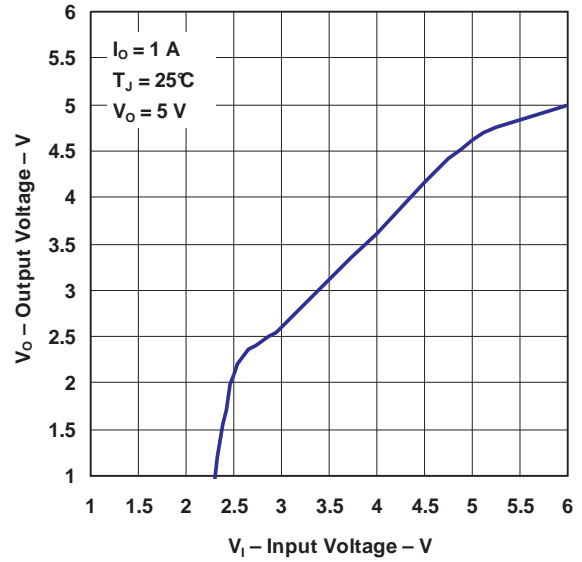

OUTPUT AT VOLTAGE EXTREMES
OUTPUT VOLTAGE
VS
INPUT VOLTAGE

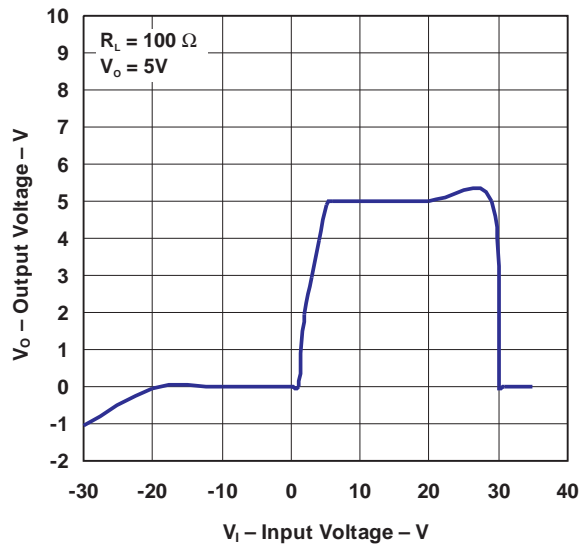

SHORT-CIRCUIT CURRENT
VS
TEMPERATURE

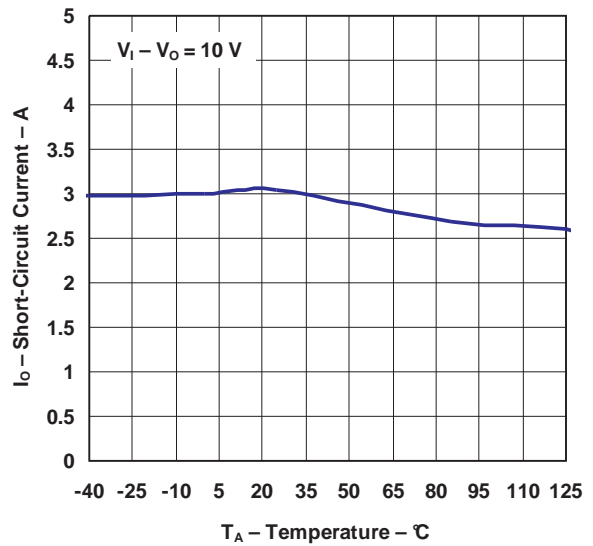

TYPICAL CHARACTERISTICS (continued)

OUTPUT IMPEDANCE
VS
FREQUENCY

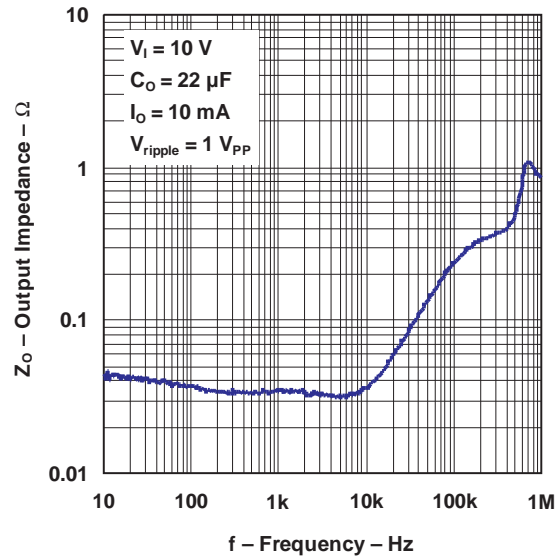

APPLICATION INFORMATION

Typical Application

Figure 1 shows a typical circuit configuration for the LM2940.

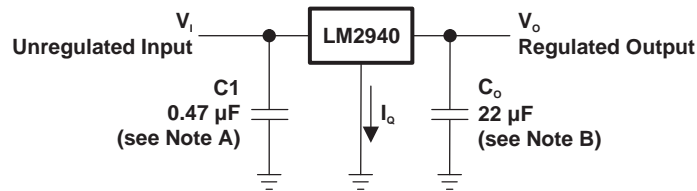

- A. Required in regulator if located far from power-supply filter
- B. C_O must be at least 22 μF to maintain stability. May be increased without bound to maintain regulation during transients. Locate as close as possible to the regulator. This capacitor must be rated over the same operating temperature range as the regulator, and proper ESR is critical.

Figure 1. Typical Application Circuit

External Capacitors

The output capacitor is critical to maintaining regulator stability and must meet the required conditions for both equivalent series resistance (ESR) and minimum capacitance.

Minimum Capacitance

The minimum output capacitance required to maintain stability is 22 μF (this value may be increased without limit). Larger values of output capacitance give improved transient response.

ESR Limits

The ESR of the output capacitor causes loop instability if it is too high or too low. The acceptable range of ESR plotted versus load current is shown in *Typical Characteristics*. It is essential that the output capacitor meet these requirements, or oscillations can result.

It is important to note that for most capacitors, ESR is specified only at room temperature. However, the designer must ensure that the ESR stays inside the limits shown over the entire operating range for the design.

For aluminum electrolytic capacitors, ESR can increase by about 30 times as the temperature is reduced from 25°C to –40°C. This type of capacitor is not well suited for low-temperature operation.

Solid tantalum capacitors have a more stable ESR over temperature, but are more expensive than aluminum electrolytics. A cost-effective approach sometimes used is to parallel an aluminum electrolytic with a solid tantalum, with the total capacitance split about 75%/25% with the aluminum being the larger value.

If two capacitors are paralleled, the effective ESR is the parallel of the two individual values. The flatter ESR or the tantalum keeps the effective ESR from rising as quickly at low temperatures.

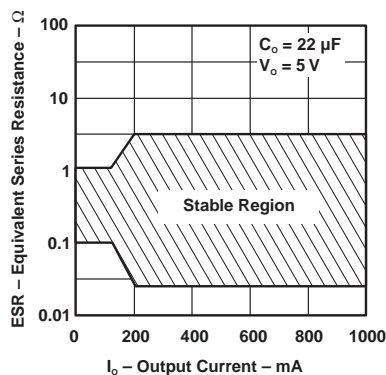

Figure 2. Output Capacitor ESR

APPLICATION INFORMATION (continued)

Heatsinking

A heatsink may be required, depending on the maximum power dissipation and maximum ambient temperature of the application. Under all possible operating conditions, the junction temperature must be within the range specified under absolute maximum ratings.

To determine if a heatsink is required, the power dissipated by the regulator, P_D , must be calculated.

Figure 3 shows the voltages and currents that are present in the circuit, as well as the formula for calculating the power dissipated in the regulator.

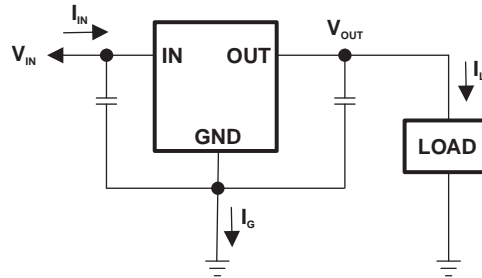

$$I_I = I_L + I_G$$

$$P_D = (V_{IN} - V_{OUT})I_L + (V_{IN})I_G$$

Figure 3. Power Dissipation

The next parameter that must be calculated is the maximum allowable temperature rise, $T_R(\max)$. This is calculated using the formula:

$$T_R(\max) = T_J(\max) - T_A(\max)$$

Where

$T_J(\max)$ is the maximum allowable junction temperature, which is 125°C for commercial parts.

$T_A(\max)$ is the maximum ambient temperature encountered in the application.

Using the calculated valued for $T_R(\max)$ and P_D , the maximum allowable value for the junction-to-ambient thermal resistance, θ_{JA} , now can be found:

$$\theta_{JA} = T_R(\max) \div P_D$$

NOTE:

If the maximum allowable value for θ_{JA} is found to be $\geq 53^\circ\text{C/W}$ for the TO-220 package, $\geq 80^\circ\text{C/W}$ for the TO-263 package, or $\geq 174^\circ\text{C/W}$ for the SOT-223 package, no heatsink is needed, because the package alone dissipates enough heat to satisfy these requirements.

If the calculated value for θ_{JA} falls below these limits, a heatsink is required.

APPLICATION INFORMATION (continued)

Heatsinking TO-220 Package Parts

The SOT-223 can be attached to a typical heatsink or secured to a copper plane on a PC board. If a copper plane is use, the values of θ_{JA} are the same as shown in under *Heatsinking TO-263 and SOT-223 Package Parts*.

If a manufactured heatsink is selected, the value of heatsink-to-ambient thermal resistance, θ_{HA} , must be calculated:

$$\theta_{HA} = \theta_{JA} - \theta_{CH} - \theta_{JC}$$

Where

θ_{JC} is defined as the thermal resistance from the junction to the surface of the case. A value of 3°C/W can be assumed for θ_{JC} for this calculation.

θ_{CH} is defined as the thermal resistance between the case and the surface of the heatsink. The value of θ_{CH} varies from about 1.5°C/W to about 2.5°C/W, depending on the method of attachment, insulator, etc. If the exact value is unknown, 2°C/W should be assumed for θ_{CH} .

Heatsinking TO-263 and SOT-223 Package Parts

Both the TO-263 and SOT-223 packages use a copper plane on the PCB and the PCB itself as a heatsink. To optimize the heatsinking ability of the plane and PCB, solder the tab of the package to the plane.

Figure 4 shows the measured values of θ_{JA} for the TO-263 for different copper area sizes using a typical PCB with 1-oz copper and no solder mask over the copper area used for heatsinking.

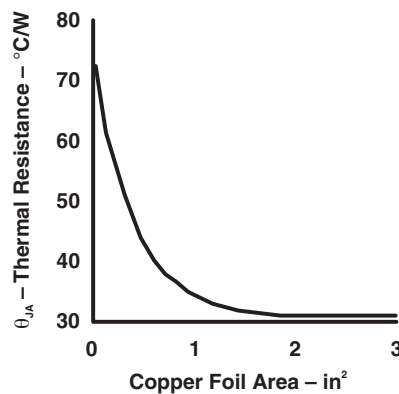

Figure 4. θ_{JA} vs Copper (1 oz) Area for TO-263 Package

As shown in Figure 4, increasing the copper area beyond 1 in² produces very little improvement. It should also be observed that the minimum value of θ_{JA} for the TO-263 package mounted to a PCB is 32°C/W.

As a design aid, Figure 5 shows the maximum allowable power dissipation compared to ambient temperature for the TO-263 device, assuming θ_{JA} is 35°C/W and the maximum junction temperature is 125°C.

APPLICATION INFORMATION (continued)

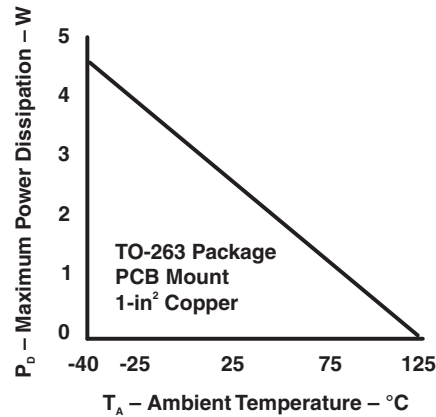

Figure 5. Maximum Power Dissipation vs Ambient Temperature for TO-263 Package

Figure 6 and Figure 7 show the information for the SOT-223 package. Figure 7 assumes a θ_{JA} of 74°C/W for 1-oz copper, 51°C/W for 2-oz copper, and a maximum junction temperature of 125°C.

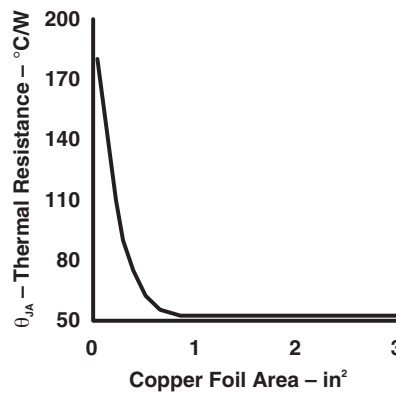

Figure 6. θ_{JA} vs Copper (2 oz) Area for SOT-223 Package

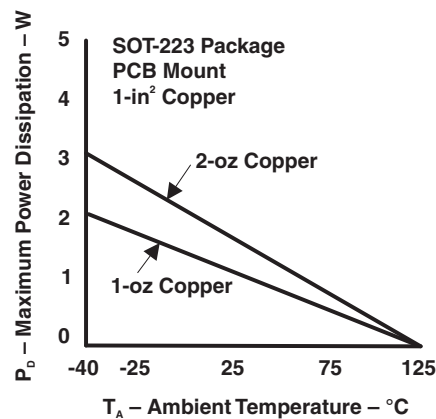

Figure 7. Maximum Power Dissipation vs Ambient Temperature for SOT-223 Package

PACKAGING INFORMATION

Orderable Device	Status ⁽¹⁾	Package Type	Package Drawing	Pins	Package Qty	Eco Plan ⁽²⁾	Lead/Ball Finish	MSL Peak Temp ⁽³⁾
LM2940-50CKCSE3	ACTIVE	TO-220	KCS	3	50	Pb-Free (RoHS)	CU SN	N / A for Pkg Type
LM2940-50IKCSE3	ACTIVE	TO-220	KCS	3	50	Pb-Free (RoHS)	CU SN	N / A for Pkg Type

⁽¹⁾ The marketing status values are defined as follows:

ACTIVE: Product device recommended for new designs.

LIFEBUY: TI has announced that the device will be discontinued, and a lifetime-buy period is in effect.

NRND: Not recommended for new designs. Device is in production to support existing customers, but TI does not recommend using this part in a new design.

PREVIEW: Device has been announced but is not in production. Samples may or may not be available.

OBsolete: TI has discontinued the production of the device.

⁽²⁾ Eco Plan - The planned eco-friendly classification: Pb-Free (RoHS), Pb-Free (RoHS Exempt), or Green (RoHS & no Sb/Br) - please check <http://www.ti.com/productcontent> for the latest availability information and additional product content details.

TBD: The Pb-Free/Green conversion plan has not been defined.

Pb-Free (RoHS): TI's terms "Lead-Free" or "Pb-Free" mean semiconductor products that are compatible with the current RoHS requirements for all 6 substances, including the requirement that lead not exceed 0.1% by weight in homogeneous materials. Where designed to be soldered at high temperatures, TI Pb-Free products are suitable for use in specified lead-free processes.

Pb-Free (RoHS Exempt): This component has a RoHS exemption for either 1) lead-based flip-chip solder bumps used between the die and package, or 2) lead-based die adhesive used between the die and leadframe. The component is otherwise considered Pb-Free (RoHS compatible) as defined above.

Green (RoHS & no Sb/Br): TI defines "Green" to mean Pb-Free (RoHS compatible), and free of Bromine (Br) and Antimony (Sb) based flame retardants (Br or Sb do not exceed 0.1% by weight in homogeneous material)

⁽³⁾ MSL, Peak Temp. -- The Moisture Sensitivity Level rating according to the JEDEC industry standard classifications, and peak solder temperature.

Important Information and Disclaimer:The information provided on this page represents TI's knowledge and belief as of the date that it is provided. TI bases its knowledge and belief on information provided by third parties, and makes no representation or warranty as to the accuracy of such information. Efforts are underway to better integrate information from third parties. TI has taken and continues to take reasonable steps to provide representative and accurate information but may not have conducted destructive testing or chemical analysis on incoming materials and chemicals. TI and TI suppliers consider certain information to be proprietary, and thus CAS numbers and other limited information may not be available for release.

In no event shall TI's liability arising out of such information exceed the total purchase price of the TI part(s) at issue in this document sold by TI to Customer on an annual basis.

KCS (R-PSFM-T3)

PLASTIC FLANGE-MOUNT PACKAGE

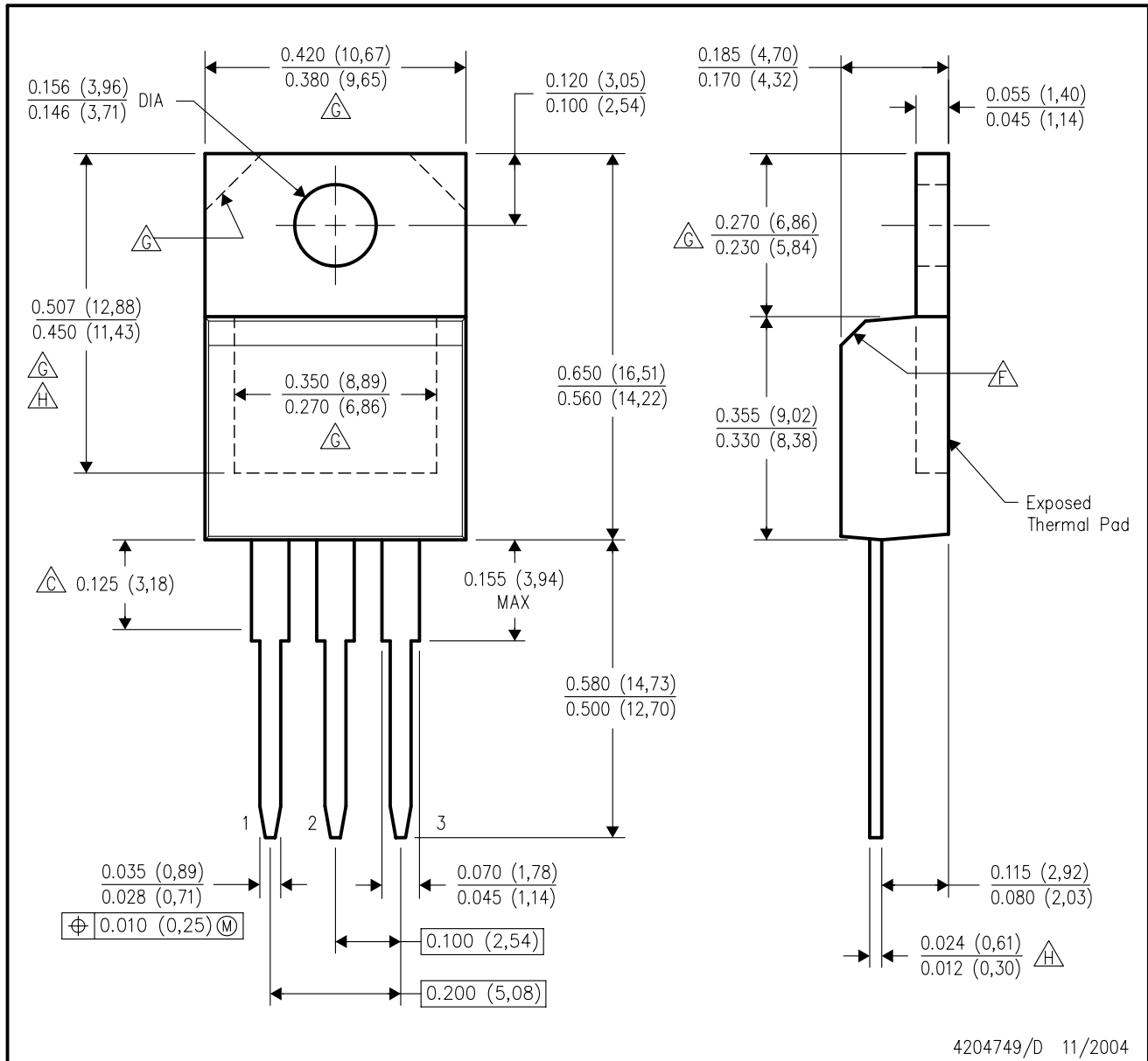

- NOTES:
- A. All linear dimensions are in inches (millimeters).
 - B. This drawing is subject to change without notice.
 - C. Lead dimensions are not controlled within this area.
 - D. All lead dimensions apply before solder dip.
 - E. The center lead is in electrical contact with the mounting tab.
 - F. The chamfer is optional.
 - G. Thermal pad contour optional within these dimensions.
 - H. Falls within JEDEC TO-220 variation AB, except minimum lead thickness and minimum exposed pad length.

IMPORTANT NOTICE

Texas Instruments Incorporated and its subsidiaries (TI) reserve the right to make corrections, modifications, enhancements, improvements, and other changes to its products and services at any time and to discontinue any product or service without notice. Customers should obtain the latest relevant information before placing orders and should verify that such information is current and complete. All products are sold subject to TI's terms and conditions of sale supplied at the time of order acknowledgment.

TI warrants performance of its hardware products to the specifications applicable at the time of sale in accordance with TI's standard warranty. Testing and other quality control techniques are used to the extent TI deems necessary to support this warranty. Except where mandated by government requirements, testing of all parameters of each product is not necessarily performed.

TI assumes no liability for applications assistance or customer product design. Customers are responsible for their products and applications using TI components. To minimize the risks associated with customer products and applications, customers should provide adequate design and operating safeguards.

TI does not warrant or represent that any license, either express or implied, is granted under any TI patent right, copyright, mask work right, or other TI intellectual property right relating to any combination, machine, or process in which TI products or services are used. Information published by TI regarding third-party products or services does not constitute a license from TI to use such products or services or a warranty or endorsement thereof. Use of such information may require a license from a third party under the patents or other intellectual property of the third party, or a license from TI under the patents or other intellectual property of TI.

Reproduction of information in TI data books or data sheets is permissible only if reproduction is without alteration and is accompanied by all associated warranties, conditions, limitations, and notices. Reproduction of this information with alteration is an unfair and deceptive business practice. TI is not responsible or liable for such altered documentation.

Resale of TI products or services with statements different from or beyond the parameters stated by TI for that product or service voids all express and any implied warranties for the associated TI product or service and is an unfair and deceptive business practice. TI is not responsible or liable for any such statements.

Following are URLs where you can obtain information on other Texas Instruments products and application solutions:

Products		Applications	
Amplifiers	amplifier.ti.com	Audio	www.ti.com/audio
Data Converters	dataconverter.ti.com	Automotive	www.ti.com/automotive
DSP	dsp.ti.com	Broadband	www.ti.com/broadband
Interface	interface.ti.com	Digital Control	www.ti.com/digitalcontrol
Logic	logic.ti.com	Military	www.ti.com/military
Power Mgmt	power.ti.com	Optical Networking	www.ti.com/opticalnetwork
Microcontrollers	microcontroller.ti.com	Security	www.ti.com/security
Low Power Wireless	www.ti.com/lpw	Telephony	www.ti.com/telephony
		Video & Imaging	www.ti.com/video
		Wireless	www.ti.com/wireless

Mailing Address: Texas Instruments
Post Office Box 655303 Dallas, Texas 75265

Looking for pricing, stock, or lifecycle information?

Click below to explore more details on WIN SOURCE:

 [View LM2940-50CKCSE3 on WIN SOURCE](#)

 [Texas Instruments](#) Information

Optimize Your Supply Chain with WIN SOURCE Solutions

-  Global Sourcing Solution
-  Obsolete Management
-  Cost Control Management
-  Shortage Management
-  Alternative Solution
-  Excess Inventory Management