



**THE DATASHEET OF  
LTC3631IDD-3.3#PBF**



# High Efficiency, High Voltage 100mA Synchronous Step-Down Converter

## FEATURES

- **Wide Input Voltage Range: Operation from 4.5V to 45V**
- **Ovoltage Lockout Provides Protection Up to 60V**
- **Internal High Side and Low Side Power Switches**
- **No Compensation Required**
- **100mA Output Current**
- **Low Dropout Operation: 100% Duty Cycle**
- **Low Quiescent Current: 12µA**
- 0.8V ±1% Feedback Voltage Reference
- Adjustable Peak Current Limit
- Internal and External Soft-Start
- Precise RUN Pin Threshold with Adjustable Hysteresis
- 3.3V, 5V and Adjustable Output Versions
- Only Three External Components Required for Fixed Output Versions
- Low Profile (0.75mm) 3mm × 3mm DFN and Thermally-Enhanced MS8E Packages

## APPLICATIONS

- 4mA to 20mA Current Loops
- Industrial Control Supplies
- Distributed Power Systems
- Portable Instruments
- Battery-Operated Devices
- Automotive Power Systems

## DESCRIPTION

The **LTC<sup>®</sup>3631** is a high voltage, high efficiency step-down DC/DC converter with internal high side and synchronous power switches that draws only 12µA typical DC supply current at no load while maintaining output voltage regulation.

The LTC3631 can supply up to 100mA load current and features a programmable peak current limit that provides a simple method for optimizing efficiency in lower current applications. The LTC3631's combination of Burst Mode<sup>®</sup> operation, integrated power switches, low quiescent current, and programmable peak current limit provides high efficiency over a broad range of load currents.

With its wide 4.5V to 45V input range and internal overvoltage monitor capable of protecting the part from 60V surges, the LTC3631 is a robust converter suited for regulating a wide variety of power sources. Additionally, the LTC3631 includes a precise run threshold and a soft-start feature to guarantee that power system start-up is well-controlled in any environment.

The LTC3631 is available in the thermally enhanced 3mm × 3mm DFN and MS8E packages.

LT, LT, LTC, LTM, Burst Mode, Linear Technology and the Linear logo are registered trademarks and ThinSOT is a trademark of Linear Technology Corporation. All other trademarks are the property of their respective owners.

## TYPICAL APPLICATION

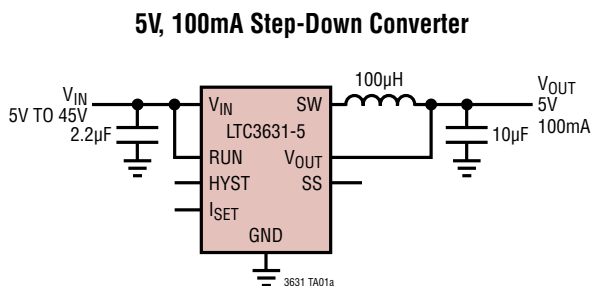

**Efficiency and Power Loss vs Load Current**

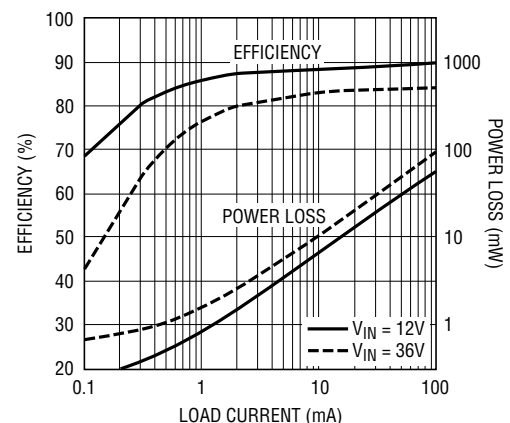

3631 TA01b

3631fe

## ABSOLUTE MAXIMUM RATINGS (Note 1)

$V_{IN}$ Supply Voltage.....	-0.3V to 60V	Operating Junction Temperature Range (Note 2).....	-40°C to 125°C
SW Voltage (DC).....	-0.3V to ( $V_{IN} + 0.3V$ )	Storage Temperature Range.....	-65°C to 150°C
RUN Voltage.....	-0.3V to 60V	Lead Temperature (Soldering, 10 sec)	
HYST, $I_{SET}$ , SS Voltages.....	-0.3V to 6V	MS8E.....	300°C
$V_{FB}$ .....	-0.3V to 6V		
$V_{OUT}$ (Fixed Output Versions).....	-0.3V to 6V		

## PIN CONFIGURATION

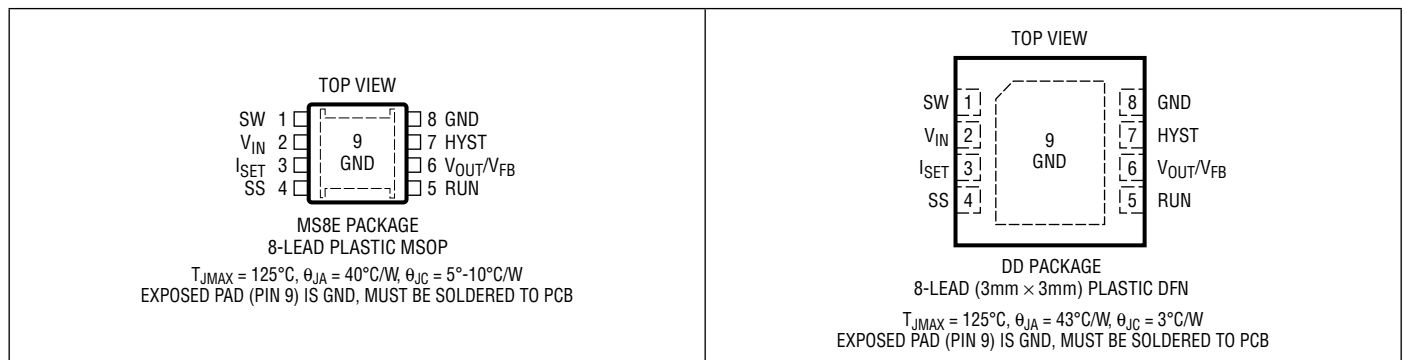

## ORDER INFORMATION

LEAD FREE FINISH	TAPE AND REEL	PART MARKING*	PACKAGE DESCRIPTION	TEMPERATURE RANGE
LTC3631EMS8E#PBF	LTC3631EMS8E#TRPBF	LTFDT	8-Lead Plastic MSOP	-40°C to 125°C
LTC3631EMS8E-3.3#PBF	LTC3631EMS8E-3.3#TRPBF	LTFPP	8-Lead Plastic MSOP	-40°C to 125°C
LTC3631EMS8E-5#PBF	LTC3631EMS8E-5#TRPBF	LTFPR	8-Lead Plastic MSOP	-40°C to 125°C
LTC3631IMS8E#PBF	LTC3631IMS8E#TRPBF	LTFDT	8-Lead Plastic MSOP	-40°C to 125°C
LTC3631IMS8E-3.3#PBF	LTC3631IMS8E-3.3#TRPBF	LTFPP	8-Lead Plastic MSOP	-40°C to 125°C
LTC3631IMS8E-5#PBF	LTC3631IMS8E-5#TRPBF	LTFPR	8-Lead Plastic MSOP	-40°C to 125°C
LTC3631EDD#PBF	LTC3631EDD#TRPBF	LFDV	8-Lead (3mm x 3mm) Plastic DFN	-40°C to 125°C
LTC3631EDD-3.3#PBF	LTC3631EDD-3.3#TRPBF	LFFN	8-Lead (3mm x 3mm) Plastic DFN	-40°C to 125°C
LTC3631EDD-5#PBF	LTC3631EDD-5#TRPBF	LFFQ	8-Lead (3mm x 3mm) Plastic DFN	-40°C to 125°C
LTC3631IDD#PBF	LTC3631IDD#TRPBF	LFDV	8-Lead (3mm x 3mm) Plastic DFN	-40°C to 125°C
LTC3631IDD-3.3#PBF	LTC3631IDD-3.3#TRPBF	LFFN	8-Lead (3mm x 3mm) Plastic DFN	-40°C to 125°C
LTC3631IDD-5#PBF	LTC3631IDD-5#TRPBF	LFFQ	8-Lead (3mm x 3mm) Plastic DFN	-40°C to 125°C

Consult LTC Marketing for parts specified with wider operating temperature ranges. \*The temperature grade is identified by a label on the shipping container. Consult LTC Marketing for information on non-standard lead based finish parts.

For more information on lead free part marking, go to: <http://www.linear.com/leadfree/>

For more information on tape and reel specifications, go to: <http://www.linear.com/tapeandree/>

## ELECTRICAL CHARACTERISTICS

The ● denotes the specifications which apply over the full operating junction temperature range, otherwise specifications are for  $T_A = 25^\circ\text{C}$  (Note 2).  $V_{IN} = 10\text{V}$ , unless otherwise noted.

SYMBOL	PARAMETER	CONDITIONS	MIN	TYP	MAX	UNITS
<b>Input Supply (<math>V_{IN}</math>)</b>						
$V_{IN}$	Input Voltage Operating Range		4.5		45	V
UVLO	$V_{IN}$ Undervoltage Lockout	$V_{IN}$ Rising $V_{IN}$ Falling Hysteresis	● 3.80 ● 3.75	4.15 4.00 150	4.50 4.35	V V mV
OVLO	$V_{IN}$ Overvoltage Lockout	$V_{IN}$ Rising $V_{IN}$ Falling Hysteresis	47 45	50 48 2	52 50	V V V
$I_Q$	DC Supply Current (Note 3) Active Mode Sleep Mode Shutdown Mode	$V_{RUN} = 0\text{V}$		125 12 3	220 22 6	$\mu\text{A}$ $\mu\text{A}$ $\mu\text{A}$
<b>Output Supply (<math>V_{OUT}/V_{FB}</math>)</b>						
$V_{OUT}$	Output Voltage Trip Thresholds	LTC3631-3.3V, $V_{OUT}$ Rising	● 3.260	3.310	3.360	V
		LTC3631-3.3V, $V_{OUT}$ Falling	● 3.240	3.290	3.340	V
		LTC3631-5V, $V_{OUT}$ Rising	● 4.940	5.015	5.090	V
		LTC3631-5V, $V_{OUT}$ Falling	● 4.910	4.985	5.060	V
$V_{FB}$	Feedback Comparator Trip Voltage	$V_{FB}$ Rising	● 0.792	0.800	0.808	V
$V_{HYST}$	Feedback Comparator Hysteresis		● 3	5	7	mV
$I_{FB}$	Feedback Pin Current	Adjustable Output Version, $V_{FB} = 1\text{V}$	-10	0	10	nA
$\Delta V_{LINEREG}$	Feedback Voltage Line Regulation	$V_{IN} = 4.5\text{V}$ to $45\text{V}$ LTC3631-5, $V_{IN} = 6\text{V}$ to $45\text{V}$		0.001		%/V
<b>Operation</b>						
$V_{RUN}$	Run Pin Threshold Voltage	RUN Rising	1.17	1.21	1.25	V
		RUN Falling	1.06	1.10	1.14	V
		Hysteresis		110		mV
$I_{RUN}$	Run Pin Leakage Current	$RUN = 1.3\text{V}$	-10	0	10	nA
$V_{HYSTL}$	Hysteresis Pin Voltage Low	$RUN < 1\text{V}$ , $I_{HYST} = 1\text{mA}$		0.07	0.1	V
$I_{HYST}$	Hysteresis Pin Leakage Current	$V_{HYST} = 1.3\text{V}$	-10	0	10	nA
$I_{SS}$	Soft-Start Pin Pull-Up Current	$V_{SS} < 1.5\text{V}$	4.5	5.5	6.5	$\mu\text{A}$
$t_{INTSS}$	Internal Soft-Start Time	SS Pin Floating		0.75		ms
$I_{PEAK}$	Peak Current Trip Threshold	$I_{SET}$ Floating	● 200	225	280	mA
		500k Resistor from $I_{SET}$ to GND		120		mA
		$I_{SET}$ Shorted to GND		40	50	65
$R_{ON}$	Power Switch On-Resistance Top Switch Bottom Switch	$I_{SW} = -25\text{mA}$		3.0		$\Omega$
		$I_{SW} = 25\text{mA}$		1.5		$\Omega$

**Note 1:** Stresses beyond those listed under Absolute Maximum Ratings may cause permanent damage to the device. Exposure to any Absolute Maximum Rating condition for extended periods may affect device reliability and lifetime.

**Note 2:** The LTC3631 is tested under pulsed load conditions such that  $T_J \approx T_A$ . The LTC3631E is guaranteed to meet specifications from  $0^\circ\text{C}$  to  $85^\circ\text{C}$  junction temperature. Specifications over the  $-40^\circ\text{C}$  to  $125^\circ\text{C}$  operating junction temperature range are assured by design, characterization and correlation with statistical process controls. The LTC3631I is guaranteed over the full  $-40^\circ\text{C}$  to  $125^\circ\text{C}$  operating junction

temperature range. Note that the maximum ambient temperature consistent with these specifications is determined by specific operating conditions in conjunction with board layout, the rated package thermal impedance and other environmental factors. The junction temperature ( $T_J$ , in  $^\circ\text{C}$ ) is calculated from the ambient temperature ( $T_A$ , in  $^\circ\text{C}$ ) and power dissipation (PD, in Watts) according to the formula:

$$T_J = T_A + (PD \cdot \theta_{JA})$$

where  $\theta_{JA}$  (in  $^\circ\text{C}/\text{W}$ ) is the package thermal impedance.

**Note 3:** Dynamic supply current is higher due to the gate charge being delivered at the switching frequency. See Applications Information.

## TYPICAL PERFORMANCE CHARACTERISTICS

**Efficiency vs Load Current,  
 $V_{OUT} = 5V$**

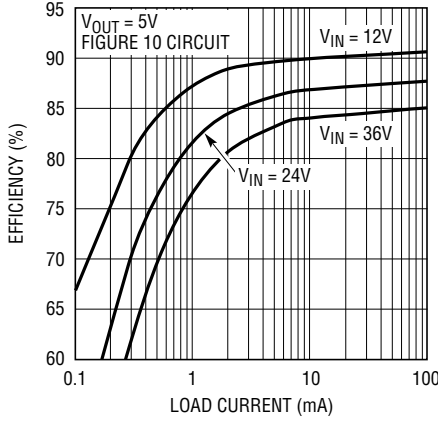

**Efficiency vs Load Current,  
 $V_{OUT} = 3.3V$**

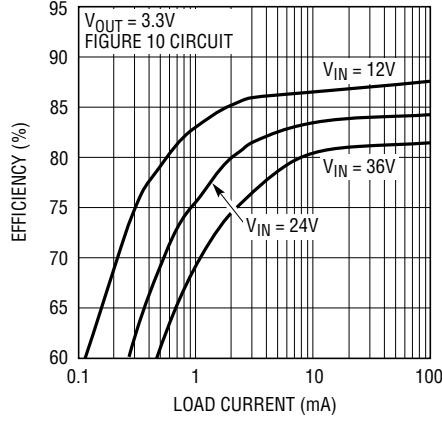

**Efficiency vs Load Current,  
 $V_{OUT} = 2.5V$**

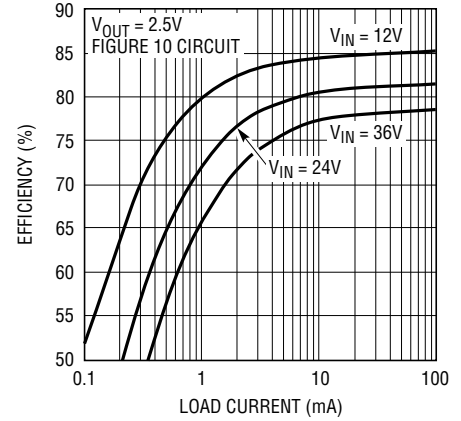

**Efficiency vs Input Voltage**

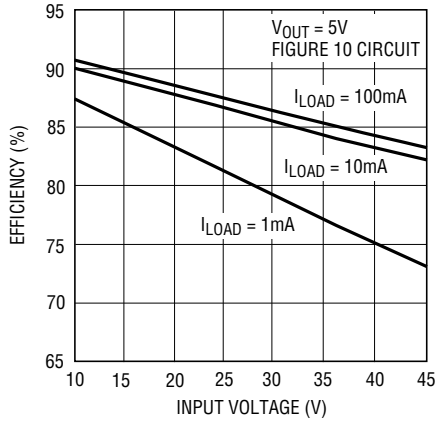

**Line Regulation**

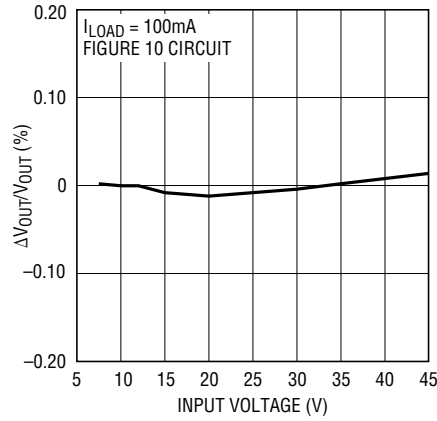

**Load Regulation**

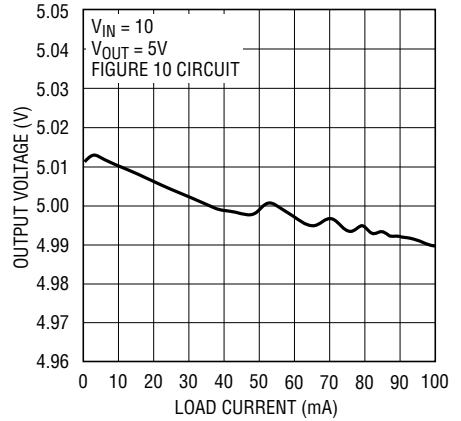

**Feedback Comparator Trip Voltage vs Temperature**

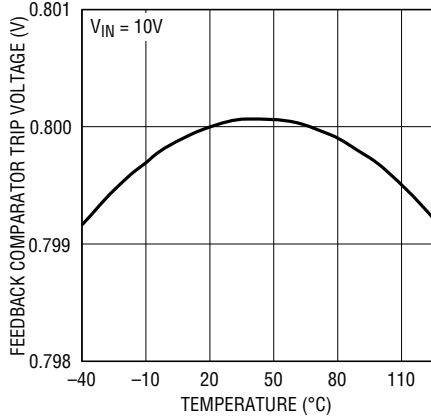

**Feedback Comparator Hysteresis vs Temperature**

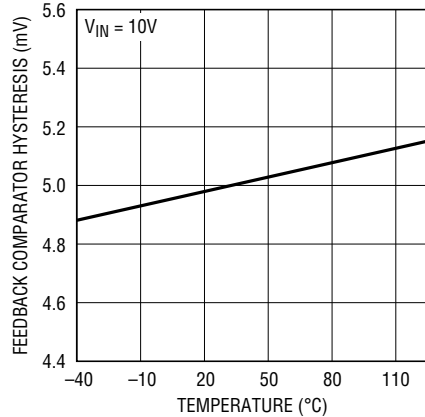

**Peak Current Trip Threshold vs Temperature and ISET**

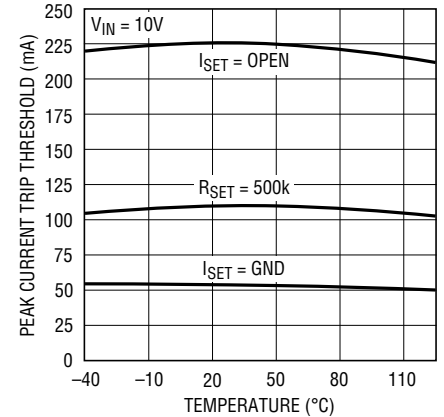

# TYPICAL PERFORMANCE CHARACTERISTICS

**Peak Current Trip Threshold vs R<sub>ISET</sub>**

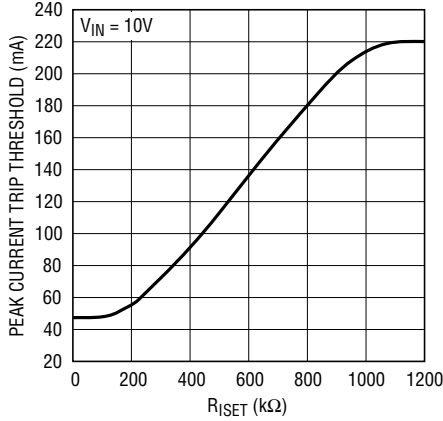

3631 G10

**Peak Current Trip Threshold vs Input Voltage**

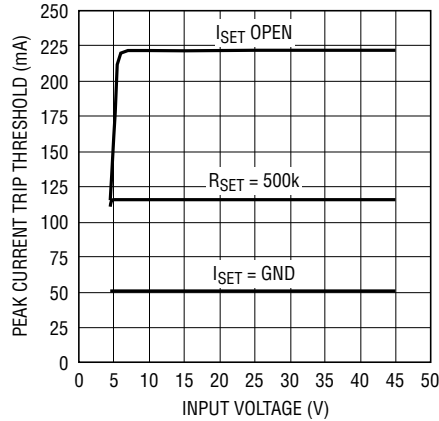

3631 G11

**Quiescent Supply Current vs Input Voltage**

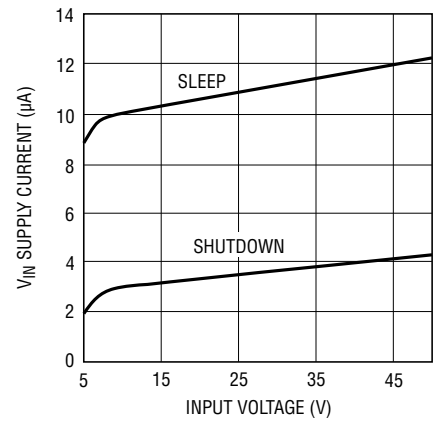

3631 G12

**Quiescent Supply Current vs Temperature**

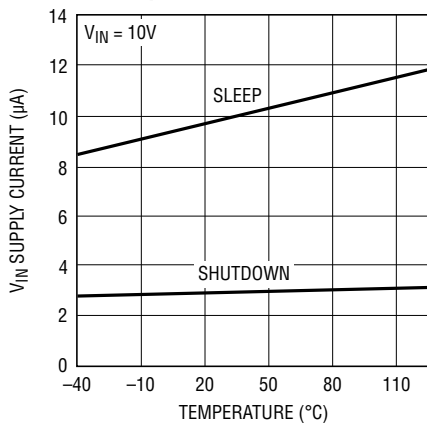

3631 G13

**Switch On-Resistance vs Input Voltage**

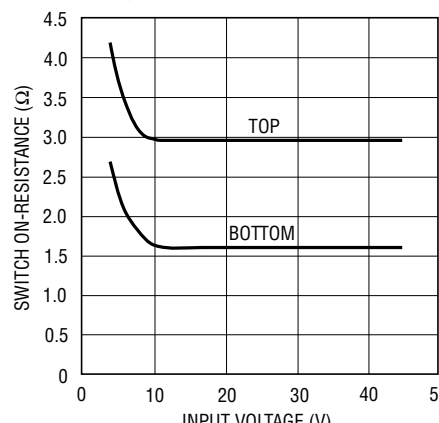

3631 G14

**Switch On-Resistance vs Temperature**

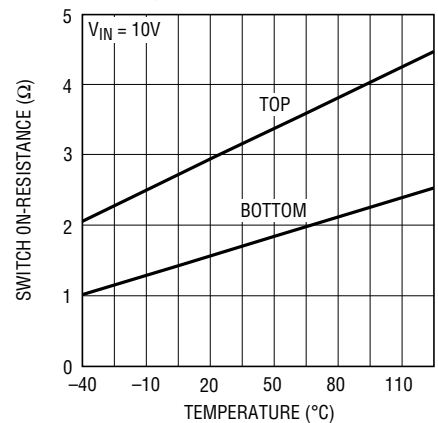

3631 G15

**Switch Leakage Current vs Temperature**

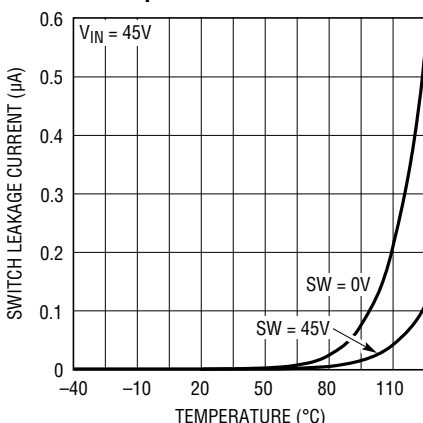

3631 G16

**RUN Comparator Threshold Voltages vs Temperature**

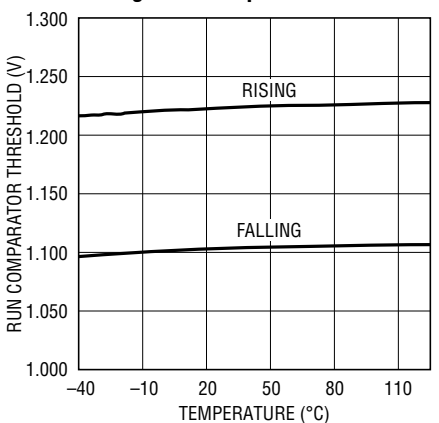

3631 G17

**Operating Waveforms**

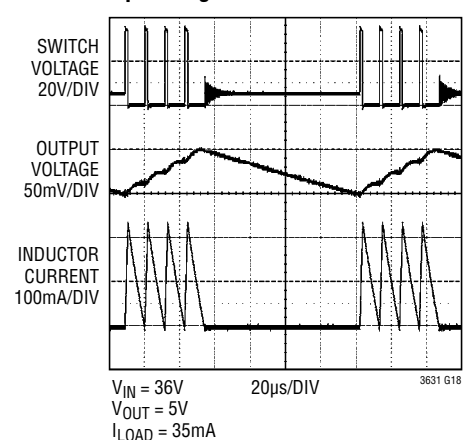

V<sub>IN</sub> = 36V  
V<sub>OUT</sub> = 5V  
I<sub>LOAD</sub> = 35mA

## TYPICAL PERFORMANCE CHARACTERISTICS

Soft-Start Waveform

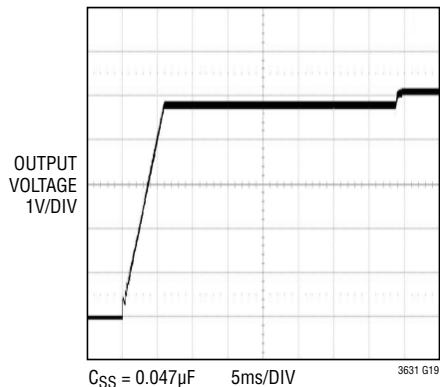

Load Step Transient Response



Short-Circuit Response

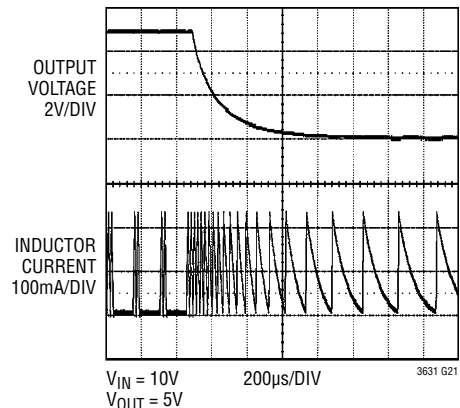

## PIN FUNCTIONS

**SW (Pin 1):** Switch Node Connection to Inductor. This pin connects to the drains of the internal power MOSFET switches.

**$V_{IN}$  (Pin 2):** Main Supply Pin. A ceramic bypass capacitor should be tied between this pin and GND (Pin 8).

**$I_{SET}$  (Pin 3):** Peak Current Set Input. A resistor from this pin to ground sets the peak current trip threshold. Leave floating for the maximum peak current (225mA). Short this pin to ground for the minimum peak current (50mA). A 1μA current is sourced out of this pin.

**SS (Pin 4):** Soft-Start Control Input. A capacitor to ground at this pin sets the ramp time to full current output during start-up. A 5μA current is sourced out of this pin. If left floating, the ramp time defaults to an internal 0.75ms soft-start.

**RUN (Pin 5):** Run Control Input. A voltage on this pin above 1.2V enables normal operation. Forcing this pin below 0.7V shuts down the LTC3631, reducing quiescent current to approximately 3μA.

**$V_{OUT}/V_{FB}$  (Pin 6):** Output Voltage Feedback. For the fixed output versions, connect this pin to the output supply. For the adjustable version, an external resistive divider should be used to divide the output voltage down for comparison to the 0.8V reference.

**HYST (Pin 7):** Run Hysteresis Open-Drain Logic Output. This pin is pulled to ground when RUN (Pin 5) is below 1.2V. This pin can be used to adjust the RUN pin hysteresis. See Applications Information.

**GND (Pin 8, Exposed Pad Pin 9):** Ground. The exposed pad must be soldered to the printed circuit board ground plane for optimal electrical and thermal performance.

# BLOCK DIAGRAM

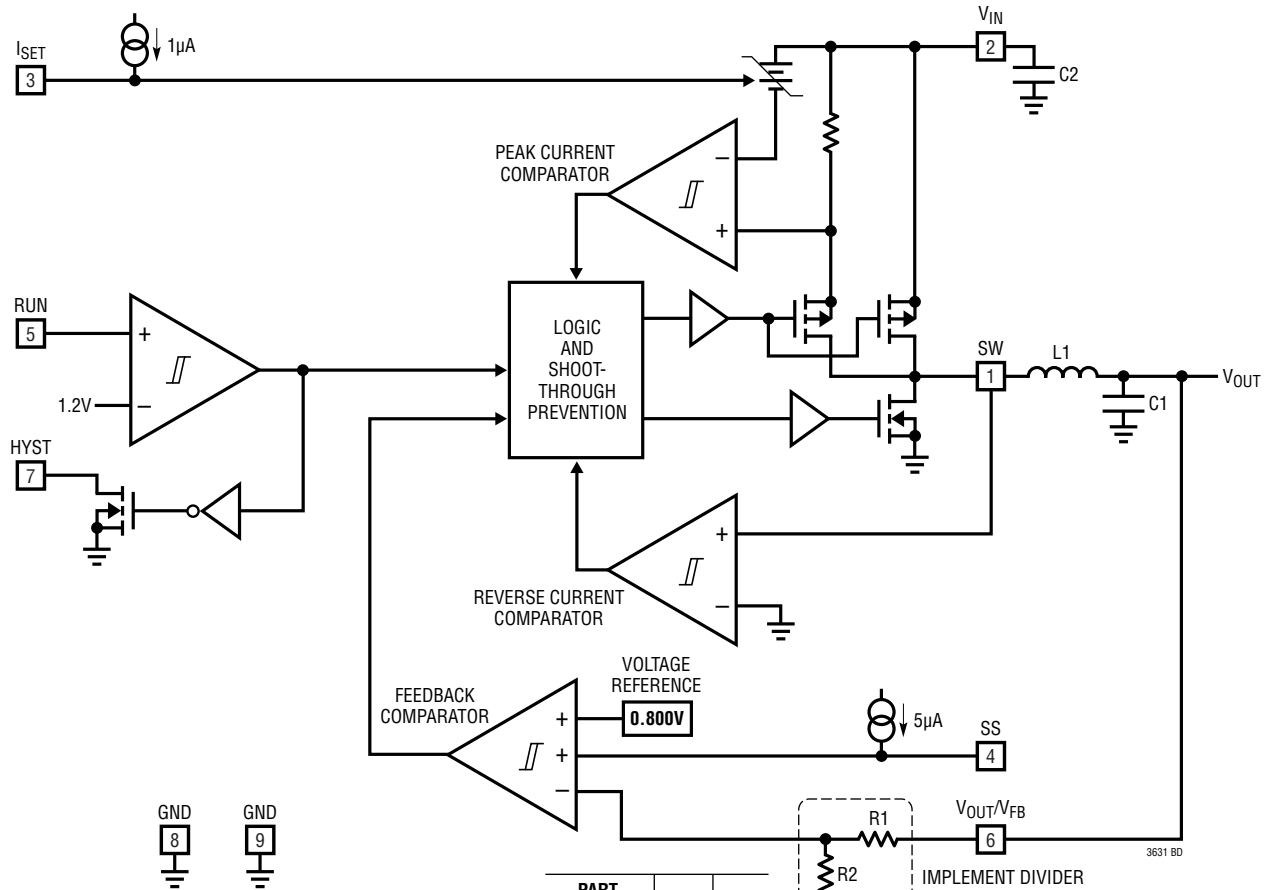

PART NUMBER	R1	R2
LTC3631	0	∞
LTC3631-3.3	2.5M	800k
LTC3631-5	4.2M	800k

IMPLEMENT DIVIDER EXTERNALLY FOR ADJUSTABLE VERSION

3631 BD

## OPERATION (Refer to Block Diagram)

The LTC3631 is a step-down DC/DC converter with internal power switches that uses Burst Mode control, combining low quiescent current with high switching frequency, which results in high efficiency across a wide range of load currents. Burst Mode operation functions by using short “burst” cycles to ramp the inductor current through the internal power switches, followed by a sleep cycle where the power switches are off and the load current is supplied by the output capacitor. During the sleep cycle, the LTC3631 draws only 12 $\mu$ A of supply current. At light loads, the burst cycles are a small percentage of the total cycle time which minimizes the average supply current, greatly improving efficiency.

### Main Control Loop

The feedback comparator monitors the voltage on the  $V_{FB}$  pin and compares it to an internal 800mV reference. If this voltage is greater than the reference, the comparator activates a sleep mode in which the power switches and current comparators are disabled, reducing the  $V_{IN}$  pin supply current to only 12 $\mu$ A. As the load current discharges the output capacitor, the voltage on the  $V_{FB}$  pin decreases. When this voltage falls 5mV below the 800mV reference, the feedback comparator trips and enables burst cycles.

At the beginning of the burst cycle, the internal high side power switch (P-channel MOSFET) is turned on and the inductor current begins to ramp up. The inductor current increases until either the current exceeds the peak current comparator threshold or the voltage on the  $V_{FB}$  pin exceeds 800mV, at which time the high side power switch is turned off, and the low side power switch (N-channel MOSFET) turns on. The inductor current ramps down until the reverse current comparator trips, signaling that the current is close to zero. If the voltage on the  $V_{FB}$  pin is still less than the 800mV reference, the high side power switch is turned on again and another cycle commences. The average current during a burst cycle will normally be

greater than the average load current. For this architecture, the maximum average output current is equal to half of the peak current.

The hysteretic nature of this control architecture results in a switching frequency that is a function of the input voltage, output voltage and inductor value. This behavior provides inherent short-circuit protection. If the output is shorted to ground, the inductor current will decay very slowly during a single switching cycle. Since the high side switch turns on only when the inductor current is near zero, the LTC3631 inherently switches at a lower frequency during start-up or short-circuit conditions.

### Start-Up and Shutdown

If the voltage on the RUN pin is less than 0.7V, the LTC3631 enters a shutdown mode in which all internal circuitry is disabled, reducing the DC supply current to 3 $\mu$ A. When the voltage on the RUN pin exceeds 1.21V, normal operation of the main control loop is enabled. The RUN pin comparator has 110mV of internal hysteresis, and therefore must fall below 1.1V to disable the main control loop.

The HYST pin provides an added degree of flexibility for the RUN pin operation. This open-drain output is pulled to ground whenever the RUN comparator is not tripped, signaling that the LTC3631 is not in normal operation. In applications where the RUN pin is used to monitor the  $V_{IN}$  voltage through an external resistive divider, the HYST pin can be used to increase the effective RUN comparator hysteresis.

An internal 1ms soft-start function limits the ramp rate of the output voltage on start-up to prevent excessive input supply droop. If a longer ramp time and consequently less supply droop is desired, a capacitor can be placed from the SS pin to ground. The 5 $\mu$ A current that is sourced out of this pin will create a smooth voltage ramp on the capacitor. If this ramp rate is slower than the internal 1ms soft-start,

## OPERATION (Refer to Block Diagram)

then the output voltage will be limited by the ramp rate on the SS pin instead. The internal and external soft-start functions are reset on start-up and after an undervoltage or overvoltage event on the input supply.

In order to ensure a smooth start-up transition in any application, the internal soft-start also ramps the peak inductor current from 50mA during its 1ms ramp time to the set peak current threshold. The external ramp on the SS pin does not limit the peak inductor current during start-up; however, placing a capacitor from the I<sub>SET</sub> pin to ground does provide this capability.

### Peak Inductor Current Programming

The offset of the peak current comparator nominally provides a peak inductor current of 225mA. This peak inductor current can be adjusted by placing a resistor

from the I<sub>SET</sub> pin to ground. The 1 $\mu$ A current sourced out of this pin through the resistor generates a voltage that is translated into an offset in the peak current comparator, which limits the peak inductor current.

### Input Undervoltage and Overvoltage Lockout

The LTC3631 implements a protection feature which disables switching when the input voltage is not within the 4.5V to 45V operating range. If V<sub>IN</sub> falls below 4V typical (4.35V maximum), an undervoltage detector disables switching. Similarly, if V<sub>IN</sub> rises above 50V typical (47V minimum), an overvoltage detector disables switching. When switching is disabled, the LTC3631 can safely sustain input voltages up to the absolute maximum rating of 60V. Switching is enabled when the input voltage returns to the 4.5V to 45V operating range.

## APPLICATIONS INFORMATION

The basic LTC3631 application circuit is shown on the front page of this data sheet. External component selection is determined by the maximum load current requirement and begins with the selection of the peak current programming resistor,  $R_{ISET}$ . The inductor value  $L$  can then be determined, followed by capacitors  $C_{IN}$  and  $C_{OUT}$ .

### Peak Current Resistor Selection

The peak current comparator has a maximum current limit of 225mA nominally, which results in a maximum average current of 112mA. For applications that demand less current, the peak current threshold can be reduced to as little as 50mA. This lower peak current allows the use of lower value, smaller components (input capacitor, output capacitor and inductor), resulting in lower input supply ripple and a smaller overall DC/DC converter.

The threshold can be easily programmed with an appropriately chosen resistor ( $R_{ISET}$ ) between the  $I_{SET}$  pin and ground. The value of resistor for a particular peak current can be computed by using Figure 1 or the following equation:

$$R_{ISET} = I_{PEAK} \cdot 4.5 \cdot 10^6$$

where  $50\text{mA} < I_{PEAK} < 225\text{mA}$ .

The peak current is internally limited to be within the range of 50mA to 225mA. Shorting the  $I_{SET}$  pin to ground programs the current limit to 50mA, and leaving it floating sets the current limit to the maximum value of 225mA. When selecting this resistor value, be aware that the

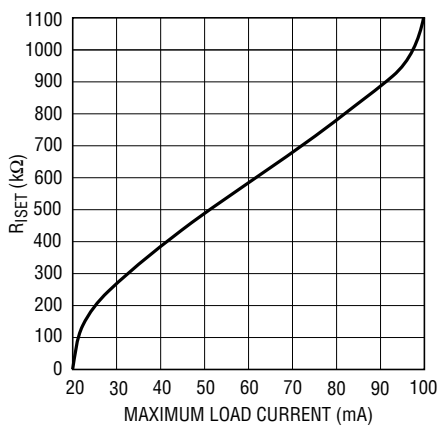

Figure 1.  $R_{ISET}$  Selection

maximum average output current for this architecture is limited to half of the peak current. Therefore, be sure to select a value that sets the peak current with enough margin to provide adequate load current under all foreseeable operating conditions.

### Inductor Selection

The inductor, input voltage, output voltage and peak current determine the switching frequency of the LTC3631. For a given input voltage, output voltage and peak current, the inductor value sets the switching frequency when the output is in regulation. A good first choice for the inductor value can be determined by the following equation:

$$L = \left( \frac{V_{OUT}}{f \cdot I_{PEAK}} \right) \cdot \left( 1 - \frac{V_{OUT}}{V_{IN}} \right)$$

The variation in switching frequency with input voltage and inductance is shown in the following two figures for typical values of  $V_{OUT}$ . For lower values of  $I_{PEAK}$ , multiply the frequency in Figure 2 and Figure 3 by  $225\text{mA}/I_{PEAK}$ .

An additional constraint on the inductor value is the LTC3631's 100ns minimum on-time of the high side switch. Therefore, in order to keep the current in the inductor well controlled, the inductor value must be chosen so that it is larger than  $L_{MIN}$ , which can be computed as follows:

$$L_{MIN} = \frac{V_{IN(MAX)} \cdot t_{ON(MIN)}}{I_{PEAK(MAX)}}$$

where  $V_{IN(MAX)}$  is the maximum input supply voltage for the application,  $t_{ON(MIN)}$  is 100ns, and  $I_{PEAK(MAX)}$  is the maximum allowed peak inductor current. Although the above equation provides the minimum inductor value, higher efficiency is generally achieved with a larger inductor value, which produces a lower switching frequency. For a given inductor type, however, as inductance is increased DC resistance (DCR) also increases. Higher DCR translates into higher copper losses and lower current rating, both of which place an upper limit on the inductance. The recommended range of inductor values for small surface mount inductors as a function of peak current is shown in Figure 4. The values in this range are a good compromise between the trade-offs discussed above. For applications

## APPLICATIONS INFORMATION

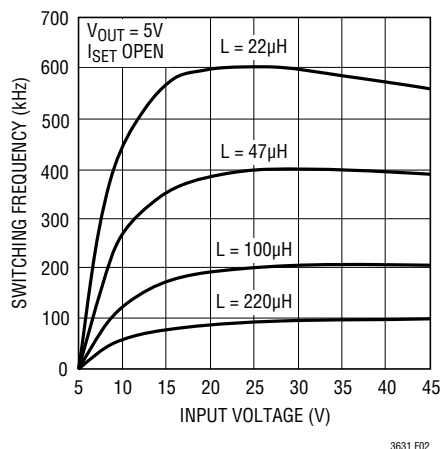

Figure 2. Switching Frequency for  $V_{OUT} = 5V$

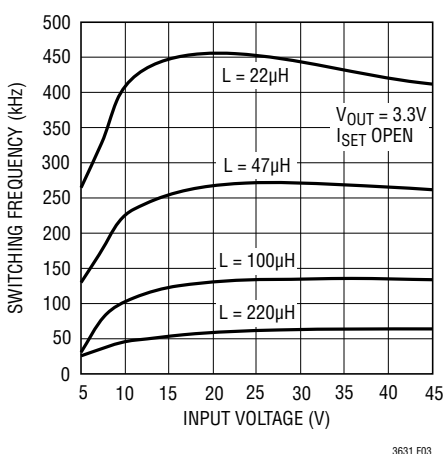

Figure 3. Switching Frequency for  $V_{OUT} = 3.3V$



Figure 4. Recommended Inductor Values for Maximum Efficiency

where board area is not a limiting factor, inductors with larger cores can be used, which extends the recommended range of Figure 4 to larger values.

### Inductor Core Selection

Once the value for L is known, the type of inductor must be selected. High efficiency converters generally cannot afford the core loss found in low cost powdered iron cores, forcing the use of the more expensive ferrite cores. Actual core loss is independent of core size for a fixed inductor value but is very dependent of the inductance selected. As the inductance increases, core losses decrease. Unfortunately, increased inductance requires more turns of wire and therefore copper losses will increase.

Ferrite designs have very low core losses and are preferred at high switching frequencies, so design goals can concentrate on copper loss and preventing saturation. Ferrite core material saturates “hard,” which means that inductance collapses abruptly when the peak design current is exceeded. This results in an abrupt increase in inductor ripple current and consequently output voltage ripple. Do not allow the core to saturate!

Different core materials and shapes will change the size/current and price/current relationship of an inductor. Toroid or shielded pot cores in ferrite or permalloy materials are small and do not radiate energy but generally cost more than powdered iron core inductors with similar characteristics. The choice of which style inductor to use mainly depends on the price vs size requirements and any radiated field/EMI requirements. New designs for surface mount inductors are available from Coiltronics, Coilcraft, TDK, Toko, Sumida and Vishay.

### $C_{IN}$ and $C_{OUT}$ Selection

The input capacitor,  $C_{IN}$ , is needed to filter the trapezoidal current at the source of the top high side MOSFET. To prevent large ripple voltage, a low ESR input capacitor sized for the maximum RMS current should be used. Approximate RMS current is given by:

$$I_{RMS} = I_{OUT(MAX)} \cdot \frac{V_{OUT}}{V_{IN}} \cdot \sqrt{\frac{V_{IN}}{V_{OUT}} - 1}$$

## APPLICATIONS INFORMATION

This formula has a maximum at  $V_{IN} = 2V_{OUT}$ , where  $I_{RMS} = I_{OUT}/2$ . This simple worst-case condition is commonly used for design because even significant deviations do not offer much relief. Note that ripple current ratings from capacitor manufacturers are often based only on 2000 hours of life which makes it advisable to further derate the capacitor, or choose a capacitor rated at a higher temperature than required. Several capacitors may also be paralleled to meet size or height requirements in the design.

The output capacitor,  $C_{OUT}$ , filters the inductor's ripple current and stores energy to satisfy the load current when the LTC3631 is in sleep. The output ripple has a lower limit of  $V_{OUT}/160$  due to the 5mV typical hysteresis of the feedback comparator. The time delay of the comparator adds an additional ripple voltage that is a function of the load current. During this delay time, the LTC3631 continues to switch and supply current to the output. The output ripple can be approximated by:

$$\Delta V_{OUT} \approx \left( \frac{I_{PEAK}}{2} - I_{LOAD} \right) \frac{4 \cdot 10^{-6}}{C_{OUT}} + \frac{V_{OUT}}{160}$$

The output ripple is a maximum at no load and approaches lower limit of  $V_{OUT}/160$  at full load. Choose the output capacitor  $C_{OUT}$  to limit the output voltage ripple at minimum load current.

The value of the output capacitor must be large enough to accept the energy stored in the inductor without a large change in output voltage. Setting this voltage step equal to 1% of the output voltage, the output capacitor must be:

$$C_{OUT} > 50 \cdot L \cdot \left( \frac{I_{PEAK}}{V_{OUT}} \right)^2$$

Typically, a capacitor that satisfies the voltage ripple requirement is adequate to filter the inductor ripple. To avoid overheating, the output capacitor must also be sized to handle the ripple current generated by the inductor. The worst-case ripple current in the output capacitor is given by  $I_{RMS} = I_{PEAK}/2$ . Multiple capacitors placed in parallel may be needed to meet the ESR and RMS current handling requirements.

Tantalum, special polymer, aluminum electrolytic, and ceramic capacitors are all available in surface mount packages. Special polymer capacitors offer very low ESR but have lower capacitance density than other types. Tantalum capacitors have the highest capacitance density but it is important only to use types that have been surge tested for use in switching power supplies. Aluminum electrolytic capacitors have significantly higher ESR but can be used in cost-sensitive applications provided that consideration is given to ripple current ratings and long-term reliability. Ceramic capacitors have excellent low ESR characteristics but can have high voltage coefficient and audible piezoelectric effects. The high quality factor (Q) of ceramic capacitors in series with trace inductance can also lead to significant ringing.

### Using Ceramic Input and Output Capacitors

Higher value, lower cost ceramic capacitors are now becoming available in smaller case sizes. Their high ripple current, high voltage rating and low ESR make them ideal for switching regulator applications. However, care must be taken when these capacitors are used at the input and output. When a ceramic capacitor is used at the input and the power is supplied by a wall adapter through long wires, a load step at the output can induce ringing at the input,  $V_{IN}$ . At best, this ringing can couple to the output and be mistaken as loop instability. At worst, a sudden inrush of current through the long wires can potentially cause a voltage spike at  $V_{IN}$  large enough to damage the LTC3631.

For applications with inductive source impedance, such as a long wire, a series RC network may be required in parallel with  $C_{IN}$  to dampen the ringing of the input supply. Figure 5 shows this circuit and the typical values required to dampen the ringing.

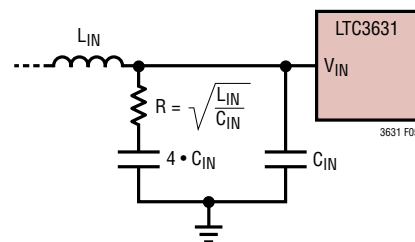

Figure 5. Series RC to Reduce  $V_{IN}$  Ringing

## APPLICATIONS INFORMATION

### Output Voltage Programming

For the adjustable version, the output voltage is set by an external resistive divider according to the following equation:

$$V_{OUT} = 0.8V \cdot \left(1 + \frac{R1}{R2}\right)$$

The resistive divider allows the  $V_{FB}$  pin to sense a fraction of the output voltage as shown in Figure 6. Output voltage can range from 0.8V to  $V_{IN}$ .

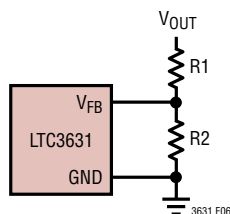

Figure 6. Setting the Output Voltage

To minimize the no-load supply current, resistor values in the megohm range should be used; however, large resistor values should be used with caution. The feedback divider is the only load current when in shutdown. If PCB leakage current to the output node or switch node exceeds the load current, the output voltage will be pulled up. In normal operation, this is generally a minor concern since the load current is much greater than the leakage. The increase in supply current due to the feedback resistors can be calculated from:

$$\Delta I_{VIN} = \left(\frac{V_{OUT}}{R1 + R2}\right) \cdot \left(\frac{V_{OUT}}{V_{IN}}\right)$$

### Run Pin with Programmable Hysteresis

The LTC3631 has a low power shutdown mode controlled by the RUN pin. Pulling the RUN pin below 0.7V puts the LTC3631 into a low quiescent current shutdown mode ( $I_Q \sim 3\mu A$ ). When the RUN pin is greater than 1.2V, the

controller is enabled. Figure 7 shows examples of configurations for driving the RUN pin from logic.

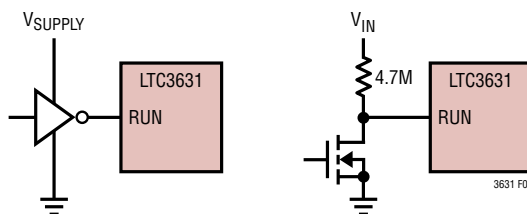

Figure 7. RUN Pin Interface to Logic

The RUN pin can alternatively be configured as a precise undervoltage lockout (UVLO) on the  $V_{IN}$  supply with a resistive divider from  $V_{IN}$  to ground. The RUN pin comparator nominally provides 10% hysteresis when used in this method; however, additional hysteresis may be added with the use of the HYST pin. The HYST pin is an open-drain output that is pulled to ground whenever the RUN comparator is not tripped. A simple resistive divider can be used as shown in Figure 8 to meet specific  $V_{IN}$  voltage requirements.

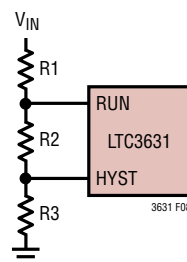

Figure 8. Adjustable Undervoltage Lockout

Specific values for these UVLO thresholds can be computed from the following equations:

$$\text{Rising } V_{IN} \text{ UVLO Threshold} = 1.21V \cdot \left(1 + \frac{R1}{R2}\right)$$

$$\text{Falling } V_{IN} \text{ UVLO Threshold} = 1.10V \cdot \left(1 + \frac{R1}{R2 + R3}\right)$$

## APPLICATIONS INFORMATION

The minimum value of these thresholds is limited to the internal  $V_{IN}$  UVLO thresholds that are shown in the Electrical Characteristics table. The current that flows through this divider will directly add to the shutdown, sleep and active current of the LTC3631, and care should be taken to minimize the impact of this current on the overall efficiency of the application circuit. Resistor values in the megohm range may be required to keep the impact on quiescent shutdown and sleep currents low. Be aware that the HYST pin cannot be allowed to exceed its absolute maximum rating of 6V. To keep the voltage on the HYST pin from exceeding 6V, the following relation should be satisfied:

$$V_{IN(MAX)} \cdot \left( \frac{R3}{R1 + R2 + R3} \right) < 6V$$

The RUN pin may also be directly tied to the  $V_{IN}$  supply for applications that do not require the programmable undervoltage lockout feature. In this configuration, switching is enabled when  $V_{IN}$  surpasses the internal undervoltage lockout threshold.

### Soft-Start

The internal 0.75ms soft-start is implemented by ramping both the effective reference voltage from 0V to 0.8V and the peak current limit set by the  $I_{SET}$  pin (50mA to 225mA).

To increase the duration of the reference voltage soft-start, place a capacitor from the SS pin to ground. An internal 5 $\mu$ A pull-up current will charge this capacitor, resulting in a soft-start ramp time given by:

$$t_{SS} = C_{SS} \cdot \frac{0.8V}{5\mu A}$$

When the LTC3631 detects a fault condition (input supply undervoltage or overvoltage) or when the RUN pin falls below 1.1V, the SS pin is quickly pulled to ground and the internal soft-start timer is reset. This ensures an orderly restart when using an external soft-start capacitor.

The duration of the 0.75ms internal peak current soft-start may be increased by placing a capacitor from the  $I_{SET}$  pin to ground. The peak current soft-start will ramp from 50mA to the final peak current value determined by a resistor

from  $I_{SET}$  to ground. A 1 $\mu$ A current is sourced out of the  $I_{SET}$  pin. With only a capacitor connected between  $I_{SET}$  and ground, the peak current ramps linearly from 50mA to 225mA, and the peak current soft-start time can be expressed as:

$$t_{SS(ISET)} = C_{ISET} \cdot \frac{0.8V}{1\mu A}$$

A linear ramp of peak current appears as a quadratic waveform on the output voltage. For the case where the peak current is reduced by placing a resistor from  $I_{SET}$  to ground, the peak current offset ramps as a decaying exponential with a time constant of  $R_{ISET} \cdot C_{ISET}$ . For this case, the peak current soft-start time is approximately  $3 \cdot R_{ISET} \cdot C_{ISET}$ .

Unlike the SS pin, the  $I_{SET}$  pin does not get pulled to ground during an abnormal event; however, if the  $I_{SET}$  pin is floating (programmed to 225mA peak current), the SS and  $I_{SET}$  pins may be tied together and connected to a capacitor to ground. For this special case, both the peak current and the reference voltage will soft-start on power-up and after fault conditions. The ramp time for this combination is  $C_{SS(ISET)} \cdot (0.8V/6\mu A)$ .

### Efficiency Considerations

The efficiency of a switching regulator is equal to the output power divided by the input power times 100%. It is often useful to analyze individual losses to determine what is limiting the efficiency and which change would produce the most improvement. Efficiency can be expressed as:

$$\text{Efficiency} = 100\% - (L1 + L2 + L3 + \dots)$$

where L1, L2, etc. are the individual losses as a percentage of input power.

Although all dissipative elements in the circuit produce losses, two main sources usually account for most of the losses:  $V_{IN}$  operating current and  $I^2R$  losses. The  $V_{IN}$  operating current dominates the efficiency loss at very low load currents whereas the  $I^2R$  loss dominates the efficiency loss at medium to high load currents.

1. The  $V_{IN}$  operating current comprises two components: The DC supply current as given in the electrical characteristics and the internal MOSFET gate charge currents.

## APPLICATIONS INFORMATION

The gate charge current results from switching the gate capacitance of the internal power MOSFET switches. Each time the gate is switched from high to low to high again, a packet of charge,  $dQ$ , moves from  $V_{IN}$  to ground. The resulting  $dQ/dt$  is the current out of  $V_{IN}$  that is typically larger than the DC bias current.

- $I^2R$  losses are calculated from the resistances of the internal switches,  $R_{SW}$ , and external inductor  $R_L$ . When switching, the average output current flowing through the inductor is “chopped” between the high side PMOS switch and the low side NMOS switch. Thus, the series resistance looking back into the switch pin is a function of the top and bottom switch  $R_{DS(ON)}$  values and the duty cycle ( $DC = V_{OUT}/V_{IN}$ ) as follows:

$$R_{SW} = (R_{DS(ON)TOP})DC + (R_{DS(ON)BOT})(1 - DC)$$

The  $R_{DS(ON)}$  for both the top and bottom MOSFETs can be obtained from the Typical Performance Characteristics curves. Thus, to obtain the  $I^2R$  losses, simply add  $R_{SW}$  to  $R_L$  and multiply the result by the square of the average output current:

$$I^2R \text{ Loss} = I_O^2(R_{SW} + R_L)$$

Other losses, including  $C_{IN}$  and  $C_{OUT}$  ESR dissipative losses and inductor core losses, generally account for less than 2% of the total power loss.

### Thermal Considerations

The LTC3631 does not dissipate much heat due to its high efficiency and low peak current level. Even in worst-case conditions (high ambient temperature, maximum peak current and high duty cycle), the junction temperature will exceed ambient temperature by only a few degrees.

### Design Example

As a design example, consider using the LTC3631 in an application with the following specifications:  $V_{IN} = 24V$ ,  $V_{OUT} = 3.3V$ ,  $I_{OUT} = 100mA$ ,  $f = 250kHz$ . Furthermore, assume for this example that switching should start when  $V_{IN}$  is greater than 12V and should stop when  $V_{IN}$  is less than 8V.

First, calculate the inductor value that gives the required switching frequency:

$$L = \left( \frac{3.3V}{250kHz \cdot 225mA} \right) \cdot \left( 1 - \frac{3.3V}{24V} \right) \cong 47\mu H$$

Next, verify that this value meets the  $L_{MIN}$  requirement. For this input voltage and peak current, the minimum inductor value is:

$$L_{MIN} = \frac{24V \cdot 100ns}{225mA} \cong 10\mu H$$

Therefore, the minimum inductor requirement is satisfied, and the 47 $\mu H$  inductor value may be used.

Next,  $C_{IN}$  and  $C_{OUT}$  are selected. For this design,  $C_{IN}$  should be sized for a current rating of at least:

$$I_{RMS} = 100mA \cdot \frac{3.3V}{24V} \cdot \sqrt{\frac{24V}{3.3V} - 1} \cong 35mA_{RMS}$$

Due to the low peak current of the LTC3631, decoupling the  $V_{IN}$  supply with a 1 $\mu F$  capacitor is adequate for most applications.

$C_{OUT}$  will be selected based on the output voltage ripple requirement. For a 2% (67mV) output voltage ripple at no load,  $C_{OUT}$  can be calculated from:

$$C_{OUT} = \frac{225mA \cdot 4 \cdot 10^{-6}}{2 \left( 67mV - \frac{3.3V}{160} \right)}$$

A 9.7 $\mu F$  capacitor gives this typical output voltage ripple at no load. Choose a 10 $\mu F$  capacitor as a standard value.

The output voltage can now be programmed by choosing the values of  $R1$  and  $R2$ . Choose  $R2 = 240k$  and calculate  $R1$  as:

$$R1 = \left( \frac{V_{OUT}}{0.8V} - 1 \right) \cdot R2 = 750k$$

## APPLICATIONS INFORMATION

The undervoltage lockout requirement on  $V_{IN}$  can be satisfied with a resistive divider from  $V_{IN}$  to the RUN and HYST pins. Choose  $R1 = 2M$  and calculate  $R2$  and  $R3$  as follows:

$$R2 = \left( \frac{1.21V}{V_{IN(RISING)} - 1.21V} \right) \cdot R1 = 224k$$

$$R3 = \left( \frac{1.1V}{V_{IN(FALLING)} - 1.1V} \right) \cdot R1 - R2 = 94.8k$$

Choose standard values for  $R2 = 226k$  and  $R3 = 95.3k$ . The  $I_{SET}$  pin should be left open in this example to select maximum peak current (225mA). Figure 9 shows a complete schematic for this design example.

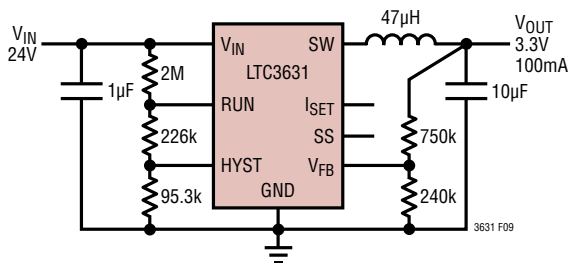

Figure 9. 24V to 3.3V, 100mA Regulator at 250kHz

### PC Board Layout Checklist

When laying out the printed circuit board, the following checklist should be used to ensure proper operation of the LTC3631. Check the following in your layout:

1. Large switched currents flow in the power switches and input capacitor. The loop formed by these components should be as small as possible. A ground plane is recommended to minimize ground impedance.

2. Connect the (+) terminal of the input capacitor,  $C_{IN}$ , as close as possible to the  $V_{IN}$  pin. This capacitor provides the AC current into the internal power MOSFETs.
3. Keep the switching node, SW, away from all sensitive small signal nodes. The rapid transitions on the switching node can couple to high impedance nodes, in particular  $V_{FB}$ , and create increased output ripple.
4. Flood all unused area on all layers with copper. Flooding with copper will reduce the temperature rise of power components. You can connect the copper areas to any DC net ( $V_{IN}$ ,  $V_{OUT}$ , GND or any other DC rail in your system).

### Example Layout

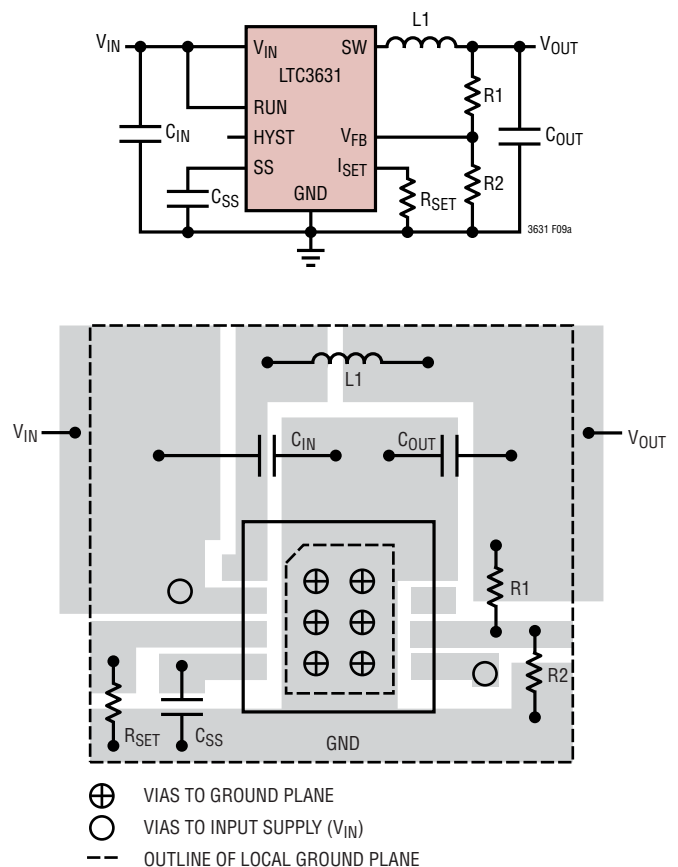

# TYPICAL APPLICATIONS

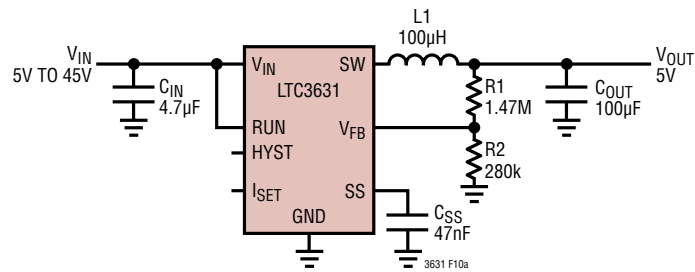

C<sub>IN</sub>: TDK C5750X7R2A475MT  
 C<sub>OUT</sub>: AVX 1812D107MAT  
 L1: TDK SLF7045T-101MR50-PF

Figure 10. High Efficiency 5V Regulator

## 3.3V, 100mA Regulator with Peak Current Soft-Start, Small Size

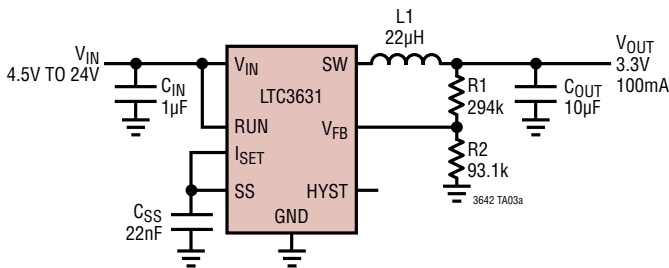

C<sub>IN</sub>: TDK C3216X7R1E105KT  
 C<sub>OUT</sub>: AVX 08056D106KAT2A  
 L1: MURATA LQH43CN220K03

## Soft-Start Waveforms

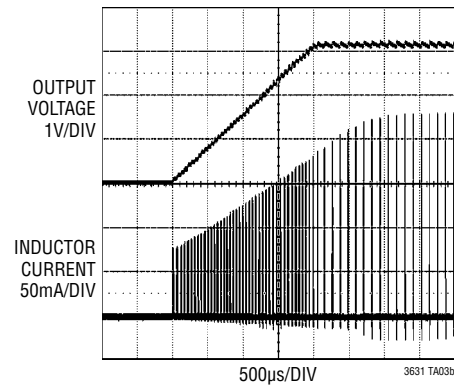

## Positive-to-Negative Converter

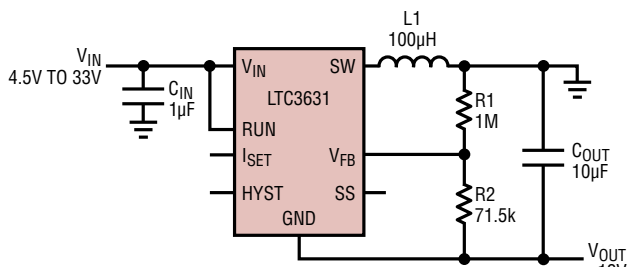

C<sub>IN</sub>: TDK C3225X7R1H105KT  
 C<sub>OUT</sub>: MURATA GRM32DR71C106KA01  
 L1: TYCO/COEV DQ6545-101M

## Maximum Load Current vs Input Voltage

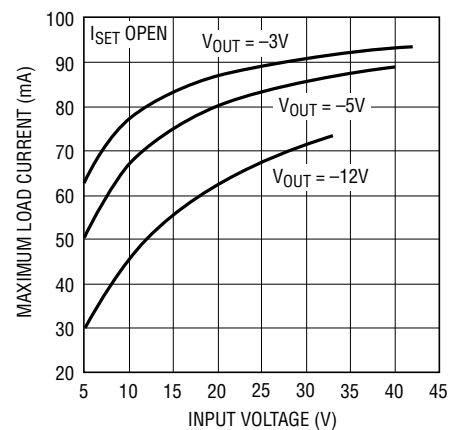

3631 TA04b

## TYPICAL APPLICATIONS

### Small Size, Limited Peak Current, 20mA Regulator

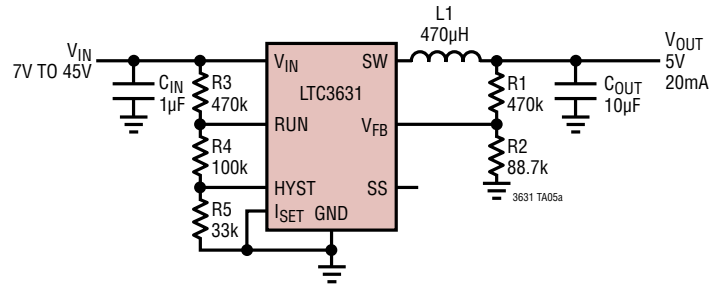

$C_{IN}$ : TDK C3225X7R1H105KT  
 $C_{OUT}$ : AVX 08056D106KAT2A  
 $L1$ : MURATA LQH43CN471K03

### High Efficiency 15V, 20mA Regulator

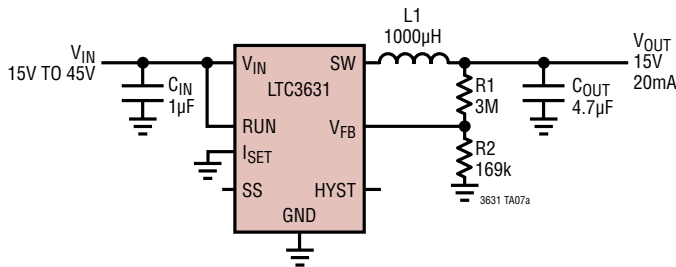

$C_{IN}$ : AVX 18125C105KAT2A  
 $C_{OUT}$ : TDK C3216X7R1E475KT  
 $L1$ : TDK SLF7045T-102MR14

### Efficiency vs Load Current



3631 TA07b



# PACKAGE DESCRIPTION

Please refer to <http://www.linear.com/designtools/packaging/> for the most recent package drawings.

## MS8E Package 8-Lead Plastic MSOP, Exposed Die Pad (Reference LTC DWG # 05-08-1662 Rev K)

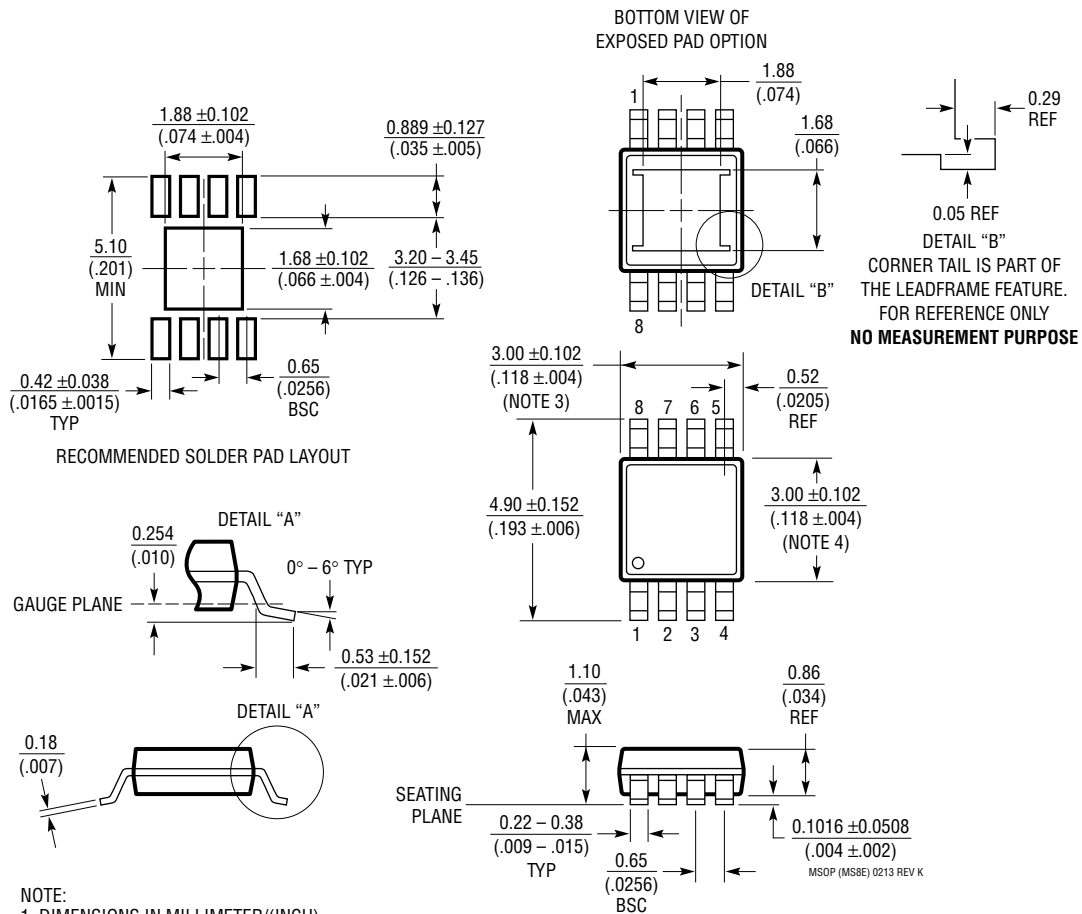

**NOTE:**

1. DIMENSIONS IN MILLIMETER/(INCH)
2. DRAWING NOT TO SCALE
3. DIMENSION DOES NOT INCLUDE MOLD FLASH, PROTRUSIONS OR GATE BURRS. MOLD FLASH, PROTRUSIONS OR GATE BURRS SHALL NOT EXCEED 0.152mm (.006") PER SIDE
4. DIMENSION DOES NOT INCLUDE INTERLEAD FLASH OR PROTRUSIONS. INTERLEAD FLASH OR PROTRUSIONS SHALL NOT EXCEED 0.152mm (.006") PER SIDE
5. LEAD COPLANARITY (BOTTOM OF LEADS AFTER FORMING) SHALL BE 0.102mm (.004") MAX
6. EXPOSED PAD DIMENSION DOES INCLUDE MOLD FLASH. MOLD FLASH ON E-PAD SHALL NOT EXCEED 0.254mm (.010") PER SIDE.

## REVISION HISTORY (Revision history begins at Rev B)

REV	DATE	DESCRIPTION	PAGE NUMBER
B	05/10	Updated Absolute Maximum Ratings and Order Information Sections	2
		Updated Note 2	3
		Updated Graphs G09, G18 and G19	4, 5, 6
		Updated GND pin text in Pin Functions	6
		Text added to “Output Voltage Programming” section	12
		“Example Layout” Art added	16
		Updated Typical Application	22
		Updated Related Parts	22
C	10/10	Updated $C_{IN}$ and $C_{OUT}$ Selection section	12
		Updated Efficiency Considerations section	15
D	08/11	Updated equation in Design Example section	16
		Updated Figure 9	16
E	05/13	<u>Clarified inductor values in Figures 2 and 3</u>	<u>11</u>

## TYPICAL APPLICATION

## 5V, 100mA Regulator for Automotive Applications

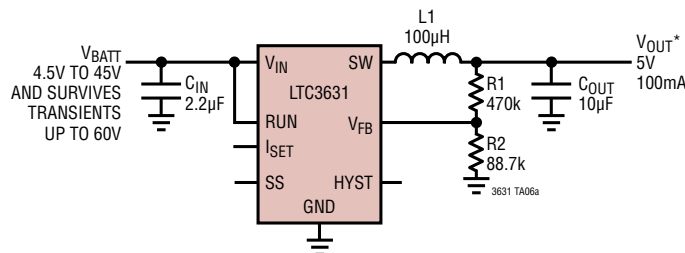

C<sub>IN</sub>: TDK C3225X7R2A225M  
 C<sub>OUT</sub>: KEMET C1210C106K4RAC  
 L1: COILTRONICS DRA73-101-R

\*V<sub>OUT</sub> = V<sub>BATT</sub> FOR V<sub>BATT</sub> < 5V

## RELATED PARTS

PART NUMBER	DESCRIPTION	COMMENTS
<a href="#">LTC3632</a>	50V, 20mA Synchronous Micropower Step-Down DC/DC Converter	V <sub>IN</sub> : 4.5V to 50V (60V <sub>MAX</sub> ), V <sub>OUT(MIN)</sub> = 0.8V, I <sub>Q</sub> = 12µA, I <sub>SD</sub> = 3µA, 3mm × 3mm DFN, MS8E
<a href="#">LTC3642</a>	45V, 50mA Synchronous Micropower Step-Down DC/DC Converter	V <sub>IN</sub> : 4.5V to 45V (60V <sub>MAX</sub> ), V <sub>OUT(MIN)</sub> = 0.8V, I <sub>Q</sub> = 12µA, I <sub>SD</sub> = 3µA, 3mm × 3mm DFN8, MS8E
<a href="#">LTC1474</a>	18V, 250mA (I <sub>OUT</sub> ), High Efficiency Step-Down DC/DC Converter	V <sub>IN</sub> : 3V to 18V, V <sub>OUT(MIN)</sub> = 1.2V, I <sub>Q</sub> = 10µA, I <sub>SD</sub> = 6µA, MS8E
<a href="#">LT1934/LT1934-1</a>	36V, 250mA (I <sub>OUT</sub> ), Micropower Step-Down DC/DC Converter with Burst Mode Operation	V <sub>IN</sub> : 3.2V to 34V, V <sub>OUT(MIN)</sub> = 1.25V, I <sub>Q</sub> = 12µA, I <sub>SD</sub> < 1µA, ThinSOT™ Package
<a href="#">LT1939</a>	25V, 2A, 2.5MHz High Efficiency DC/DC Converter and LDO Controller	V <sub>IN</sub> : 3.6V to 25V, V <sub>OUT(MIN)</sub> = 0.8V, I <sub>Q</sub> = 2.5mA, I <sub>SD</sub> < 10µA, 3mm × 3mm DFN10
<a href="#">LT1976/LT1977</a>	60V, 1.2A (I <sub>OUT</sub> ), 200kHz/500kHz, High Efficiency Step-Down DC/DC Converter with Burst Mode Operation	V <sub>IN</sub> : 3.3V to 60V, V <sub>OUT(MIN)</sub> = 1.2V, I <sub>Q</sub> = 100µA, I <sub>SD</sub> < 1µA, TSSOP16E
<a href="#">LT3437</a>	60V, 400mA (I <sub>OUT</sub> ), Micropower Step-Down DC/DC Converter with Burst Mode Operation	V <sub>IN</sub> : 3.3V to 60V, V <sub>OUT(MIN)</sub> = 1.25V, I <sub>Q</sub> = 100µA, I <sub>SD</sub> < 1µA, 3mm × 3mm DFN10, TSSOP16E
<a href="#">LT3470</a>	40V, 250mA (I <sub>OUT</sub> ), High Efficiency Step-Down DC/DC Converter with Burst Mode Operation	V <sub>IN</sub> : 4V to 40V, V <sub>OUT(MIN)</sub> = 1.2V, I <sub>Q</sub> = 26µA, I <sub>SD</sub> < 1µA, 2mm × 3mm DFN8, ThinSOT
<a href="#">LT3685</a>	36V with Transient Protection to 60V, 2A (I <sub>OUT</sub> ), 2.4MHz, High Efficiency Step-Down DC/DC Converter	V <sub>IN</sub> : 3.6V to 38V, V <sub>OUT(MIN)</sub> = 0.78V, I <sub>Q</sub> = 70µA, I <sub>SD</sub> < 1µA, 3mm × 3mm DFN10, MSOP10E

## Looking for pricing, stock, or lifecycle information?

Click below to explore more details on WIN SOURCE:

- ⊖ [View LTC3631IDD-3.3#PBF on WIN SOURCE](#)
- ⊖ [Analog Devices Inc. Information](#)

## Optimize Your Supply Chain with WIN SOURCE Solutions

- ✓ Global Sourcing Solution
- ✓ Obsolete Management
- ✓ Cost Control Management
- ✓ Shortage Management
- ✓ Alternative Solution
- ✓ Excess Inventory Management