



**THE DATASHEET OF
LX13043CLD**



DESCRIPTION

The LX13043 positive voltage linear regulator is configured with a fixed 3.3V output, featuring low dropout, tight line, load and thermal regulation. V_{OUT} is controlled and predictable as UVLO and output slew rate govern the start-up phase.

The LX13043 regulator is stable with ceramic, tantalum or electrolytic capacitors; typically 10 μ F is sufficient in most applications. This provides designers with a flexible power management solution.

The regulator design is optimized for system efficiency by consuming minimal ground current and directing quiescent current to the load.

IMPORTANT: For the most current data, consult MICROSEMI's website: <http://www.microsemi.com>

The LX13043 features on-chip trimming of the internal voltage enabling precise output voltages. The BiPolar output transistor has a low dropout voltage even at full output current (V_{DO} < 1.2V typical @ 1.0A). Output voltage overshoot is minimized for rapid supply rise times on V_{IN}, such as; 5V / μ S ramp.

Thermal and Short Circuit Current Protection are integrated on-chip.

Microsemi's micro power package is JEDEC compliant with MO-229 and meets the full RoHS initiative for Pb-free content.

KEY FEATURES

- Accurate Output Voltage
- Typical Dropout of 1.2V at 1.0A
- Independent Thermal and Current Limit Protection
- No Minimum Load Rqmt. for I_{OUT}
- Tight Load Regulation (0.4%)
- Wide DC Supply: 4.5V to 10V
- Loop Stability Independent of Output Capacitor Type
- 1mm Height SMT Power Package, 3x3mm Footprint
- Package is Lead Free and RoHS Compliant

APPLICATIONS

- 5V to 3.3V Regulator
- Hard Disk Drives, CD-ROMs
- ADSL and Cable Modems
- Battery Charging Circuits
- Instrumentation
- PC Peripherals

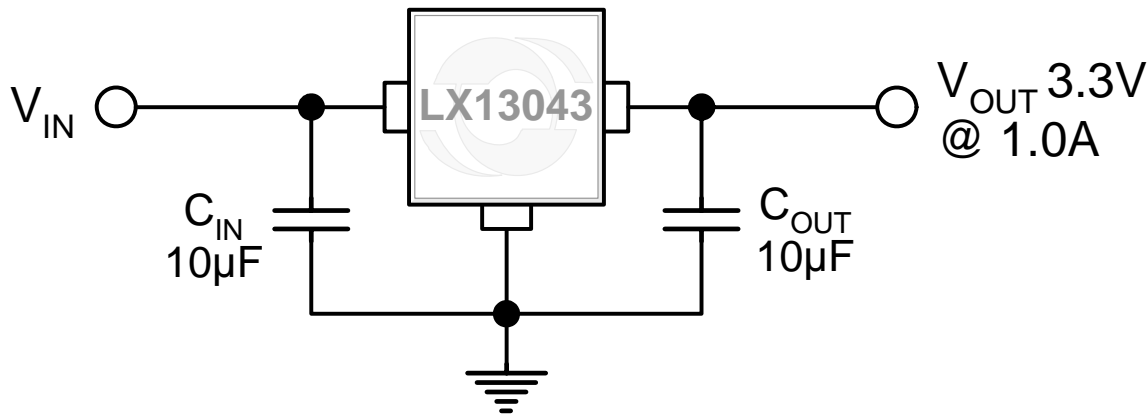
PRODUCT HIGHLIGHT

PACKAGE ORDER INFO

T _J (°C)	OUTPUT V	LD Plastic MO-229 6-PIN RoHS Compliant / Pb-free	Part Marking
0 to 125	3.3V	LX13043CLD	3043

Note: Available in Tape & Reel. Append the letters "TR" to the part number. (i.e. LX13043CLD-TR)

ABSOLUTE MAXIMUM RATINGS

Input Voltage (VIN).....	13.5V
Load Current.....	Internally Limited
Power Dissipation.....	Internally Limited
Short-Circuit Protection.....	Indefinite
Operating Junction Temperature.....	150°C
Storage Temperature Range.....	-65°C to 150°C
Peak Package Solder Reflow Temp. (40 seconds max. exposure).....	260°C (+0,-5)

Note: Exceeding these ratings could cause damage to the device. All voltages are with respect to Ground. Currents are positive into, negative out of specified terminal.

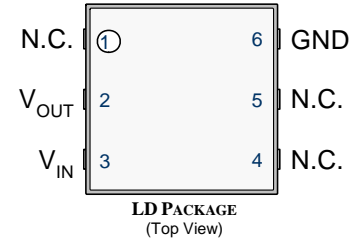
PACKAGE PIN OUT

RoHS / Pb-free 100% Matte Tin Lead Finish

*HS Must be connected to GND or left floating (see pages 6 and 7 for details)

N.C. – No Internal Connection

THERMAL DATA
LD Plastic MO-229 6-Pin

THERMAL RESISTANCE-JUNCTION TO TAB, θ_{JT}	6°C/W
THERMAL RESISTANCE-JUNCTION TO AMBIENT, θ_{JA} (TYPICAL, DEPENDING ON MOUNTING / PCB LAYOUT)	25-50°C/W

Junction Temperature Calculation: $T_J = T_A + (P_D \times \theta_{JA})$.

The θ_{JA} numbers are guidelines for the thermal performance of the device/pc-board system. All of the above assume no ambient airflow. θ_{JA} can vary significantly depending on mounting technique. (See Application Notes Section: Thermal considerations)

FUNCTIONAL PIN DESCRIPTION

PIN NAME	DESCRIPTION
V _{IN}	Positive unregulated supply input for the regulator. Bypass to GND with at least 10µF of low ESR and ESL capacitance.
GND	Common terminal for ground reference. The input and output bypass capacitors should be connected to this pin. In addition the tab on the “LD” package is also used for heat sinking the device.
V _{OUT}	Regulator output. It is recommended to bypass to GND with at least 10µF. Size your output capacitor to meet the transient loading requirement. If you have a very dynamic load, a lower ESR capacitor will improve the response to these load steps.

OPERATING RATING

Parameter	Symbol	LX13043			Units
		Min	Typ	Max	
Input Voltage	V _{IN}	4.5		10	V
Load Current (with adequate heat sinking)	I _L			1000	mA
Operating Junction Temperature	T _J			140	°C

Operating Rating: Conditions for which the device is intended to be functional but does not guarantee electrical characteristics meet the minimum / maximum limits. V_{OUT} to remain within ±10% of nominal from 125 to 140°C T_J

ELECTRICAL CHARACTERISTICS

The following specifications apply over the operating ambient temperature $0^{\circ}\text{C} \leq T_J \leq 125^{\circ}\text{C}$ except where otherwise noted and with the following test conditions: $V_{IN} = 5\text{V}$, $I_{OUT} = 10\text{mA}$, $C_{IN} = 10\mu\text{F}$ (Tantalum or Ceramic), $C_{OUT} = 10\mu\text{F}$ (Tantalum or Ceramic) and $T_J = T_A$ using low duty cycling methods.

Parameter	Symbol	Test Conditions	LX13043			Units
			Min	Typ	Max	
Fixed Output (3.3V)						
Output Voltage	V_{OUT}	$5\text{mA} < I_{OUT} < 1.0\text{A}$, $4.75\text{V} < V_{IN} < 5.25\text{V}$	3.2175	3.300	3.3825	V
Line Regulation	$\Delta V_{OUT}(V_{IN})$	$4.75\text{V} < V_{IN} < 5.25\text{V}$, $I_{OUT} = 10\text{mA}$		6	15	mV
Load Regulation	$\Delta V_{OUT}(I_{OUT})$	$10\text{mA} < I_{OUT} < 1.0\text{A}$, $V_{IN} = 4.75\text{V}$		8	12	mV
Dropout Voltage (PWR)	ΔV	$I_{LOAD} = 1.0\text{A}$, $\Delta V_{OUT} = -1\%$		1.18	1.3	V
		$I_{LOAD} = 0.5\text{A}$, $\Delta V_{OUT} = -1\%$		1.1	1.17	
Current Limit	$I_{OUT(MAX)}$	$V_{IN} = 5.5\text{V}$, V_{OUT} @ -10% from nominal	1.0			A
Minimum Load Current	I_L	Note 1			0	mA
Regulator Stability	C_{OUT} ESR	ESR measured at 10KHz $2.2\mu\text{F} \leq C_{OUT} \leq 22\mu\text{F}$ guaranteed stability for V_{OUT} , Note 2	10			m Ω
Transient Response: Change of V_{OUT} From Fast V_{IN}	$V_{OUT(MAX)}$	V_{INPUT} rise time $> 1\mu\text{S}$, $10\text{mA} < I_{OUT} < 1.0\text{A}$ Note 2	3.0		3.6	V
Transient Response: Change of V_{OUT} to Short Ckt	$V_{OUT(MAX)}$	I_{OUT} sequenced from Short to 10mA, I_{LOAD} fall time of $> 1\mu\text{s}$, $V_{IN} = 5\text{V}$. Note 2	3.0		3.6	V
Transient Response: Change of V_{OUT} to Step Load	V_{OUT}	I_{OUT} sequenced from 10mA to 1.0A, I_{LOAD} rise time of $> 1\mu\text{s}$, $V_{IN} = 5\text{V}$, Note 2	3.0		3.6	V
Quiescent Current	I_Q	$V_{IN} < 7\text{V}$, $2\text{mA} < I_{OUT} < 1.0\text{A}$		2.6	3.4	mA
Ripple Rejection	PSRR	$F = 120\text{Hz}$, $V_{IN} = 5\text{V}$, Note 2		40		dB
RMS Output Noise (% of V_{OUT})	$V_{OUT(RMS)}$	$10\text{Hz} < f < 10\text{kHz}$		0.003		%/V
Thermal Shutdown	T_{JSD}	$4.75\text{V} < V_{IN} < 5.25\text{V}$, Thermal shutdown is met when I_{OUT} to the load is reduced to $\leq 5\text{mA}$, Note 2	140	150		$^{\circ}\text{C}$

Note 1: Minimum load current is defined as the amount of output current required to maintain regulation.

Note 2: Performance is assured by design characterization and correlation with statistical process control.

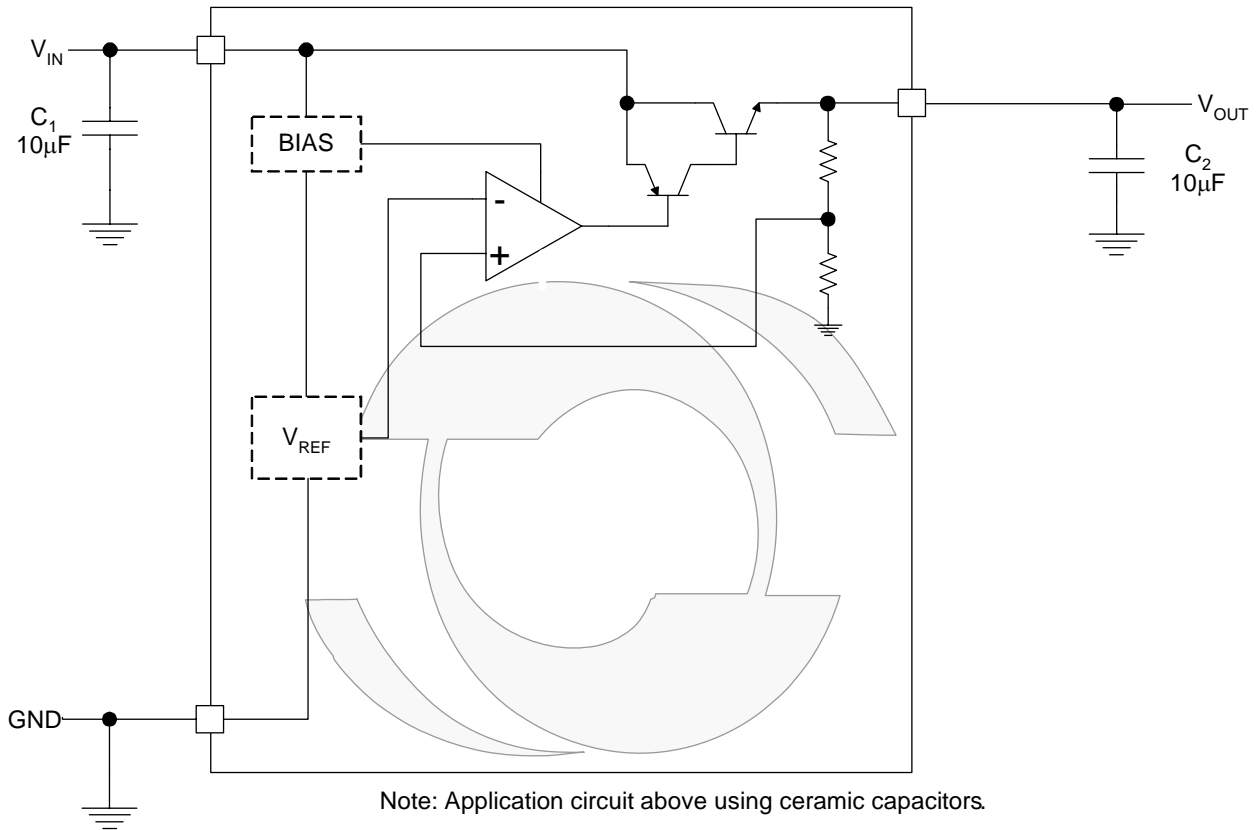
BLOCK DIAGRAM

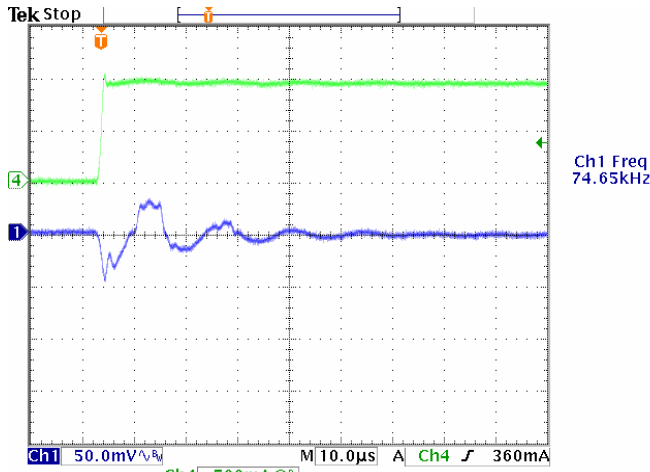
Figure 1 – Fixed Output

CHARACTERISTIC CURVES
STEP LOAD STABILITY 10mA TO 1.0A

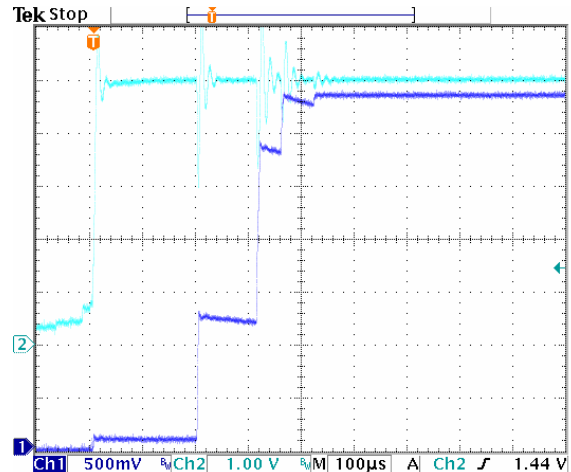
CH1: V_{OUT} , CH4: I_{STEP} , $C_{IN} = 10\mu F$, $C_{OUT} = 10\mu F$ Ceramic, $V_{DROOP} = 50mV$

SUPPLY VOLTAGE, FAST TURN ON ($TRISE = 1\mu S$)

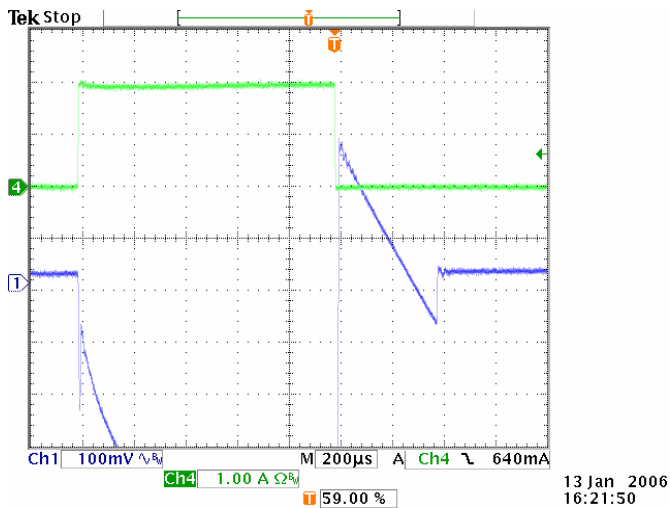
CH1: V_{OUT} , CH2: V_{IN} , $C_{IN} = 10\mu F$, $C_{OUT} = 10\mu F$ Ceramic, Load Current, DC = 10mA

SHORT CIRCUIT AND RECOVERY

CH1: V_{OUT} , CH4: I_{OUT} 1A/div, $C_{IN} = 10\mu F$, $C_{OUT} = 10\mu F$ Ceramic

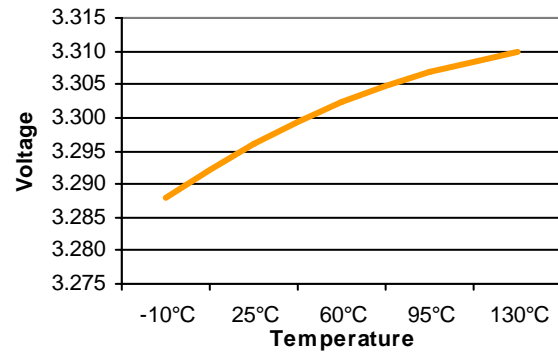
VOLTAGE OVER TEMPERATURE

APPLICATION INFORMATION**DESCRIPTION**

The LX13043 is part of a family of LDO (Low Drop-Out) linear regulators in the JEDEC MO-229 package which offers maximum power dissipation in a low profile surface mount technology. The family includes either fixed or adjustable output versions. The output can supply up to 1.0A with a regulator design optimized for system efficiency by consuming minimal ground current and directing quiescent current to the load.

INPUT CAPACITOR

To improve load transient response and noise rejection an input bypass capacitor of at least 10 μ F is required. Generally we recommend a 10 μ F ceramic or tantalum or 22 μ F electrolytic capacitor.

OUTPUT CAPACITOR

The regulator requires an output capacitor connected between VOUT to GND to stabilize the internal control loop. Many types of capacitors are available, with different capacitance values tolerances, temperature coefficients and equivalent series resistance. We recommend a minimum of 10 μ F to ensure good transient response from the power supply system under rapidly changing current load conditions. Designers generally use additional output capacitors connected in parallel. Such an arrangement serves to minimize the effects of the parasitic resistance (ESR) and inductance (ESL) that are present in all capacitors. The regulator has been tested stable with capacitor ESR's in the range of 0.03 to 3 ohms. We have found it best to use the same type of capacitor for both input and output bypass.

MINIMUM LOAD REQUIREMENT

The LX13043 does not have a minimum load requirement for proper output regulation.

TEMPERATURE PROTECTION

The thermal protection shuts the LX13043 down when the junction temperature exceeds 160°C. Exposure to absolute maximum rated conditions for extended periods may affect device reliability (see Thermal Considerations below).

CURRENT LIMIT PROTECTION

The LX13043 includes over current protection. When the output load current exceeds the internal threshold, the circuit forces the regulator output voltage to decrease.

THERMAL CONSIDERATIONS

Thermal shutdown protects the integrated circuit from thermal overload caused from a rise in junction temperature during power dissipation. This means of protection is intended for fault protection only and not as a means of current or power limiting during normal application usage. Proper thermal evaluation should be done to ensure that the junction temperature does not exceed its maximum rating. Operating beyond the maximum T_J of 150°C can impact reliability. Due to variation in individual device electrical characteristics and thermal resistance, the built in thermal overload protection may be activated at power levels slightly above or below the rated dissipation. Also peak output power should be considered for each individual output.

Power dissipation for regulator can be calculated using the following equation:

$$P_D = (V_{IN(MAX)} - V_{OUT}) * I_{OUT}$$

(Note: power dissipation resulting from quiescent (ground) current is negligible)

For the 3 x 3mm, 6 lead MO-229 package, thermal resistance, $\theta_{JUNCTION-AMB}$ is 25-45°C/W depending on component placement and ground plane area that serves as the heatsink (HS) when mounting on a FR4 copper clad PCB. Junction temperature of the integrated circuit can be calculated using:

$$T_{JUNCTION} = T_{JUNCTION-HS RISE} + T_{HS-AMB RISE} + T_{AMB}$$

$$T_{HEATSINK} = P_{D MAX} * \theta_{J-HS} ;$$

$$T_{TB-AMB} = P_{D REG} * \theta_{PCB}$$

An example: Given conditions:

$$T_A = 50^\circ\text{C}, V_{IN} = 5.0\text{V}, V_{OUT} = 3.3\text{V}, I_{OUT} = 800\text{mA}.$$

Calculated values:

$$T_{J-HS RISE} = (5\text{V} - 3.3\text{V}) * (0.8\text{A}) * 6^\circ\text{C/W} = (1.36\text{W}) * 6^\circ\text{C/W} = 8.2^\circ\text{C}$$

$$T_{HS-AMB RISE} = (1.36\text{W}) * 32^\circ\text{C/W} = 43.5^\circ\text{C}$$

$$T_{JUNCTION} = 8.2^\circ\text{C} + 43.5^\circ\text{C} + 50^\circ\text{C} = 101.7^\circ\text{C}$$

It is important to note although the output rating of the regulator is 1.0A, heat generated from power dissipation may limit the useful current draw. The junction temperature should be calculated for actual operating conditions (V_{IN}, T_{AMB}, I_{OUT}, θ_{PCB}) to insure the maximum junction temperature is not exceeded.

SOLDER REFLOW

The LX13043 package design has been engineered to meet the Lead Free Reflow Profile (260°C) for a JEDEC J-STD 020B MSL1 rating and does not contain Pb.

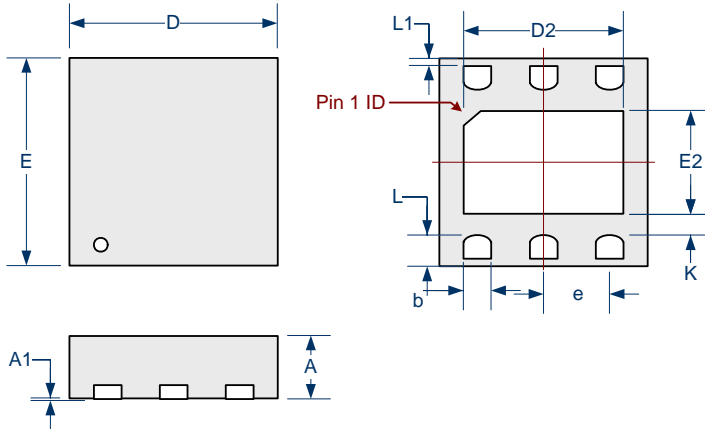
MECHANICAL DRAWINGS
LD
MO-229 6 Pin Plastic 3 x 3 x .9 mm

Dim	MILLIMETERS		INCHES	
	MIN	MAX	MIN	MAX
A	0.80	1.00	0.031	0.039
A1	0.00	0.05	0.000	0.002
K	0.20 MIN		0.008 MIN	
e	0.95 BSC		0.037 BSC	
L	0.30	0.50	0.012	0.02
b	0.30	0.45	0.012	0.018
D2	1.90	2.40	0.75	0.094
E2	1.15	1.65	0.045	0.065
D	3.00 BSC		0.118 BSC	
E	3.00 BSC		0.118 BSC	
L1	0.00	0.15	0.000	0.006

Note:

1. Dimensions do not include mold flash or protrusions; these shall not exceed 0.155mm(.006") on any side. Lead dimension shall not include solder coverage.



Microsemi[®]

LX13043

1.0A Low Dropout Regulator



PRODUCTION DATA SHEET

NOTES

PRODUCTION DATA – Information contained in this document is proprietary to Microsemi and is current as of publication date. This document may not be modified in any way without the express written consent of Microsemi. Product processing does not necessarily include testing of all parameters. Microsemi reserves the right to change the configuration and performance of the product and to discontinue product at any time.

Looking for pricing, stock, or lifecycle information?

Click below to explore more details on WIN SOURCE:

-  [View LX13043CLD on WIN SOURCE](#)
-  [Microsemi Corporation](#) Information

Optimize Your Supply Chain with WIN SOURCE Solutions

-  Global Sourcing Solution
-  Obsolete Management
-  Cost Control Management
-  Shortage Management
-  Alternative Solution
-  Excess Inventory Management