



THE DATASHEET OF CD4093BM



CMOS Quad 2-Input NAND Schmitt Triggers

High-Voltage Types (20 Volt Rating)

■ CD4093B consists of four Schmitt-trigger circuits. Each circuit functions as a two-input NAND gate with Schmitt-trigger action on both inputs. The gate switches at different points for positive- and negative-going signals. The difference between the positive voltage (V_P) and the negative voltage (V_N) is defined as hysteresis voltage (V_H) (see Fig. 2).

The CD4093B types are supplied in 14-lead hermetic dual-in-line ceramic packages (F3A suffix), 14-lead dual-in-line plastic packages (E suffix), 14-lead small-outline packages (M, MT, M96, and NSR suffixes), and 14-lead thin shrink small-outline packages (PW and PWR suffixes).

Features:

- Schmitt-trigger action on each input with no external components
- Hysteresis voltage typically 0.9 V at $V_{DD} = 5\text{ V}$ and 2.3 V at $V_{DD} = 10\text{ V}$
- Noise immunity greater than 50%
- No limit on input rise and fall times
- Standardized, symmetrical output characteristics
- 100% tested for quiescent current at 20 V
- Maximum input current of $1\ \mu\text{A}$ at 18 V over full package-temperature range, 100 nA at 18 V and 25°C
- 5-V, 10-V, and 15-V parametric ratings
- Meets all requirements of JEDEC Standard No. 13B, "Standard Specifications for Description of 'B' Series CMOS Devices"

Applications:

- Wave and pulse shapers
- High-noise-environment systems
- Monostable multivibrators
- Astable multivibrators
- NAND logic

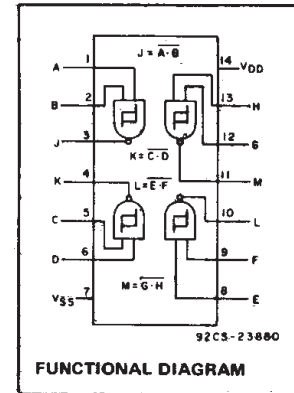

RECOMMENDED OPERATING CONDITIONS

For maximum reliability, nominal operating conditions should be selected so that operation is always within the following ranges.

| CHARACTERISTIC | MIN. | MAX. | UNITS |
|---|------|------|-------|
| Supply Voltage Range ($T_A = \text{Full Package Temp. Range}$) | 3 | 18 | V |

MAXIMUM RATINGS, Absolute-Maximum Values:

| | |
|---|--------------------------|
| DC SUPPLY-VOLTAGE RANGE, (V_{DD}) | |
| Voltages referenced to V_{SS} Terminal | -0.5V to +20V |
| INPUT VOLTAGE RANGE, ALL INPUTS | -0.5V to $V_{DD} + 0.5V$ |
| DC INPUT CURRENT, ANY ONE INPUT | $\pm 10\text{ mA}$ |
| PACKAGE THERMAL IMPEDANCE, θ_{JA} (See Note 1): | |
| E package | 80°C/W |
| M package | 86°C/W |
| NS package | 76°C/W |
| DEVICE DISSIPATION PER OUTPUT TRANSISTOR | |
| FOR $T_A = \text{FULL PACKAGE-TEMPERATURE RANGE}$ (All Package Types) | 100mW |
| OPERATING-TEMPERATURE RANGE (T_A) | -55°C to +125°C |
| STORAGE TEMPERATURE RANGE (T_{stg}) | -65°C to +150°C |
| LEAD TEMPERATURE (DURING SOLDERING): | |
| At distance $1/16 \pm 1/32$ inch ($1.59 \pm 0.79\text{mm}$) from case for 10s max | +265°C |

NOTE 1: Package thermal impedance is calculated in accordance with JESD 51-7.



* ALL INPUTS PROTECTED BY CMOS PROTECTION NETWORK

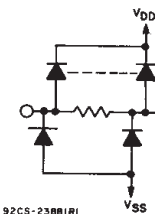

Fig. 1 – Logic diagram—1 of 4 Schmitt triggers.

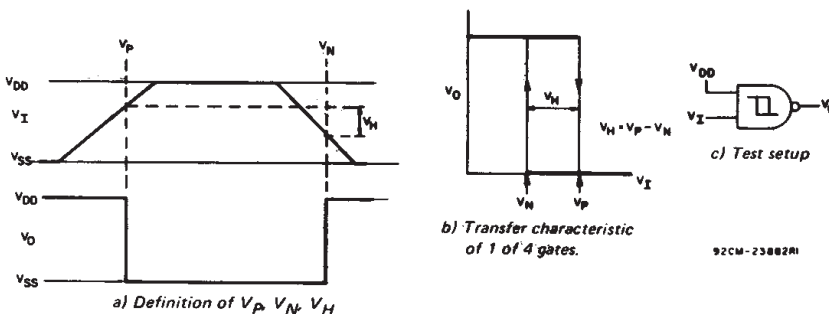

Fig. 2 – Hysteresis definition, characteristic, and test setup.

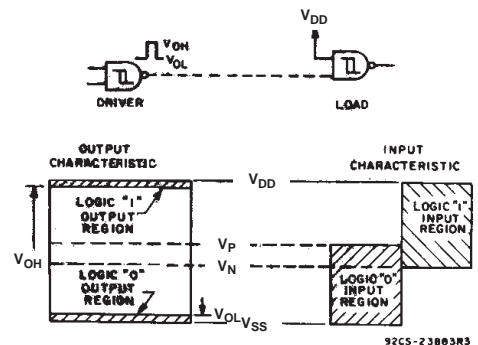

Fig. 3 – Input and output characteristics.

CD4093B Types

STATIC ELECTRICAL CHARACTERISTICS

| CHARACTERISTIC | CONDITIONS | | | LIMITS AT INDICATED TEMPERATURES (°C) | | | | | | | UNITS |
|--|-----------------------|------------------------|------------------------|---------------------------------------|------|------|------|------|------|------|-------|
| | V _O (V) | V _{IN} (V) | V _{DD} (V) | -55 | -40 | +85 | +125 | +25 | | | |
| | | | | | | | | MIN. | TYP. | MAX. | |
| Quiescent Device Current, I _{DD} Max. | - | 0.5 | 5 | 1 | 1 | 30 | 30 | - | 0.02 | 1 | μA |
| | - | 0.10 | 10 | 2 | 2 | 60 | 60 | - | 0.02 | 2 | |
| | - | 0.15 | 15 | 4 | 4 | 120 | 120 | - | 0.02 | 4 | |
| | - | 0.20 | 20 | 20 | 20 | 600 | 600 | - | 0.04 | 20 | |
| Positive Trigger Threshold Voltage V _p Min. | - | a | 5 | 2.2 | 2.2 | 2.2 | 2.2 | 2.2 | 2.9 | - | V |
| | - | a | 10 | 4.6 | 4.6 | 4.6 | 4.6 | 4.6 | 5.9 | - | |
| | - | a | 15 | 6.8 | 6.8 | 6.8 | 6.8 | 6.8 | 8.8 | - | |
| | - | b | 5 | 2.6 | 2.6 | 2.6 | 2.6 | 2.6 | 3.3 | - | |
| | - | b | 10 | 5.6 | 5.6 | 5.6 | 5.6 | 5.6 | 7 | - | |
| | - | b | 15 | 6.3 | 6.3 | 6.3 | 6.3 | 6.3 | 9.4 | - | |
| V _p Max. | - | a | 5 | 3.6 | 3.6 | 3.6 | 3.6 | - | 2.9 | 3.6 | V |
| | - | a | 10 | 7.1 | 7.1 | 7.1 | 7.1 | - | 5.9 | 7.1 | |
| | - | a | 15 | 10.8 | 10.8 | 10.8 | 10.8 | - | 8.8 | 10.8 | |
| | - | b | 5 | 4 | 4 | 4 | 4 | - | 3.3 | 4 | |
| | - | b | 10 | 8.2 | 8.2 | 8.2 | 8.2 | - | 7 | 8.2 | |
| | - | b | 15 | 12.7 | 12.7 | 12.7 | 12.7 | - | 9.4 | 12.7 | |
| Negative Trigger Threshold Voltage V _N Min. | - | a | 5 | 0.9 | 0.9 | 0.9 | 0.9 | 0.9 | 1.9 | - | V |
| | - | a | 10 | 2.5 | 2.5 | 2.5 | 2.5 | 2.5 | 3.9 | - | |
| | - | a | 15 | 4 | 4 | 4 | 4 | 4 | 5.8 | - | |
| | - | b | 5 | 1.4 | 1.4 | 1.4 | 1.4 | 1.4 | 2.3 | - | |
| | - | b | 10 | 3.4 | 3.4 | 3.4 | 3.4 | 3.4 | 5.1 | - | |
| | - | b | 15 | 4.8 | 4.8 | 4.8 | 4.8 | 4.8 | 7.3 | - | |
| V _N Max. | - | a | 5 | 2.8 | 2.8 | 2.8 | 2.8 | - | 1.9 | 2.8 | V |
| | - | a | 10 | 5.2 | 5.2 | 5.2 | 5.2 | - | 3.9 | 5.2 | |
| | - | a | 15 | 7.4 | 7.4 | 7.4 | 7.4 | - | 5.8 | 7.4 | |
| | - | b | 5 | 3.2 | 3.2 | 3.2 | 3.2 | - | 2.3 | 3.2 | |
| | - | b | 10 | 6.6 | 6.6 | 6.6 | 6.6 | - | 5.1 | 6.6 | |
| | - | b | 15 | 9.6 | 9.6 | 9.6 | 9.6 | - | 7.3 | 9.6 | |
| Hysteresis Voltage V _H Min. | - | a | 5 | 0.3 | 0.3 | 0.3 | 0.3 | 0.3 | 0.9 | - | V |
| | - | a | 10 | 1.2 | 1.2 | 1.2 | 1.2 | 1.2 | 2.3 | - | |
| | - | a | 15 | 1.6 | 1.6 | 1.6 | 1.6 | 1.6 | 3.5 | - | |
| | - | b | 5 | 0.3 | 0.3 | 0.3 | 0.3 | 0.3 | 0.9 | - | |
| | - | b | 10 | 1.2 | 1.2 | 1.2 | 1.2 | 1.2 | 2.3 | - | |
| | - | b | 15 | 1.6 | 1.6 | 1.6 | 1.6 | 1.6 | 3.5 | - | |
| V _H Max. | - | a | 5 | 1.6 | 1.6 | 1.6 | 1.6 | - | 0.9 | 1.6 | V |
| | - | a | 10 | 3.4 | 3.4 | 3.4 | 3.4 | - | 2.3 | 3.4 | |
| | - | a | 15 | 5 | 5 | 5 | 5 | - | 3.5 | 5 | |
| | - | b | 5 | 1.6 | 1.6 | 1.6 | 1.6 | - | 0.9 | 1.6 | |
| | - | b | 10 | 3.4 | 3.4 | 3.4 | 3.4 | - | 2.3 | 3.4 | |
| | - | b | 15 | 5 | 5 | 5 | 5 | - | 3.5 | 5 | |

^a Input on terminals 1,5,8,12 or 2,6,9,13; other inputs to V_{DD}.

^b Input on terminals 1 and 2, 5 and 6, 8 and 9, or 12 and 13; other inputs to V_{DD}.

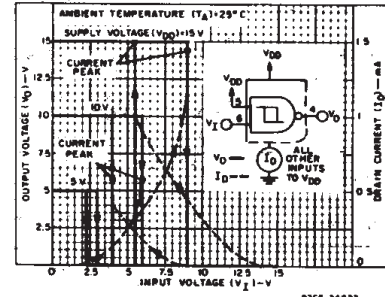

Fig. 4 - Typical current and voltage transfer characteristics.

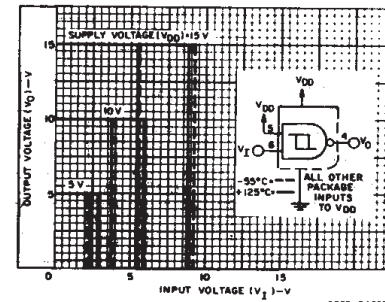

Fig. 5 - Typical voltage transfer characteristics as a function of temperature.

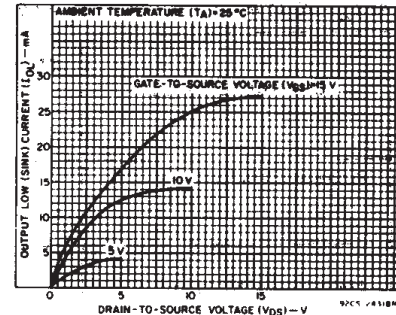

Fig. 6 - Typical output low (sink) current characteristics.

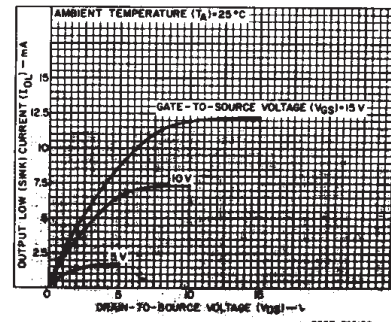

Fig. 7 - Minimum output low (sink) current characteristics.

CD4093B Types

STATIC ELECTRICAL CHARACTERISTICS (CONT'D)

| CHARACTERISTIC | CONDITIONS | | | LIMITS AT INDICATED TEMPERATURES (°C) | | | | | | | UNITS |
|--|-----------------------|------------------------|------------------------|---------------------------------------|-------|-------|-------|-------|-------------------|------|-------|
| | V _O (V) | V _{IN} (V) | V _{DD} (V) | -55 | -40 | +85 | +125 | +25 | | | |
| | | | | | | | | MIN. | TYP. | MAX. | |
| Output Low (Sink) Current, I _{OL} Min. | 0.4 | 0.5 | 5 | 0.64 | 0.61 | 0.42 | 0.36 | 0.51 | 1 | — | mA |
| | 0.5 | 0.10 | 10 | 1.6 | 1.5 | 1.1 | 0.9 | 1.3 | 2.6 | — | |
| | 1.5 | 0.15 | 15 | 4.2 | 4 | 2.8 | 2.4 | 3.4 | 6.8 | — | |
| Output High (Source) Current, I _{OH} Min. | 4.6 | 0.5 | 5 | -0.64 | -0.61 | -0.42 | -0.36 | -0.51 | -1 | — | mA |
| | 2.5 | 0.5 | 5 | -2 | -1.8 | -1.3 | -1.15 | -1.6 | -3.2 | — | |
| | 9.5 | 0.10 | 10 | -1.6 | -1.5 | -1.1 | -0.9 | -1.3 | -2.6 | — | |
| | 13.5 | 0.15 | 15 | -4.2 | -4 | -2.8 | -2.4 | -3.4 | -6.8 | — | |
| Output Voltage Low-Level, V _{OL} Max. | — | 0.5 | 5 | 0.05 | | | | — | 0 | 0.05 | V |
| | — | 0.10 | 10 | 0.05 | | | | — | 0 | 0.05 | |
| | — | 0.15 | 15 | 0.05 | | | | — | 0 | 0.05 | |
| Output Voltage High-Level, V _{OH} Min. | — | 0.5 | 5 | 4.95 | | | | 4.95 | 5 | — | V |
| | — | 0.10 | 10 | 9.95 | | | | 9.95 | 10 | — | |
| | — | 0.15 | 15 | 14.95 | | | | 14.95 | — | — | |
| Input Current, I _{IN} Max. | — | 0.18 | 18 | ±0.1 | ±0.1 | ±1 | ±1 | — | ±10 ⁻⁵ | ±0.1 | μA |

DYNAMIC ELECTRICAL CHARACTERISTICS

At T_A = 25°C; Input t_r, t_f = 20 ns, C_L = 50 pF, R_L = 200kΩ

| CHARACTERISTIC | TEST CONDITIONS | LIMITS | | | UNITS |
|---|-----------------|--------------------------|------|------|-------|
| | | V _{DD} VOLTS | TYP. | MAX. | |
| Propagation Delay Time: t _{PHL} t _{PLH} | | 5 | 190 | 380 | ns |
| | | 10 | 90 | 180 | |
| | | 15 | 65 | 130 | |
| Transition Time, t _{THL} t _{TLH} | | 5 | 100 | 200 | ns |
| | | 10 | 50 | 100 | |
| | | 15 | 40 | 80 | |
| Input Capacitance, C _{IN} | Any Input | | 5 | 7.5 | pF |

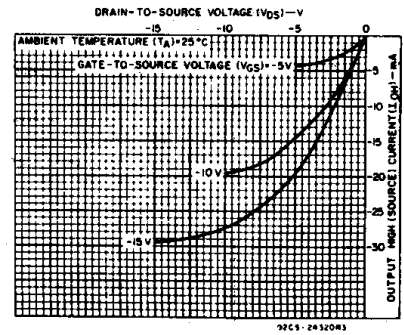

Fig. 8 – Typical output high (source) current characteristics.

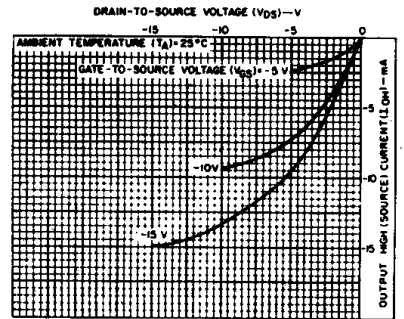

Fig. 9 – Minimum output high (source) current characteristics.

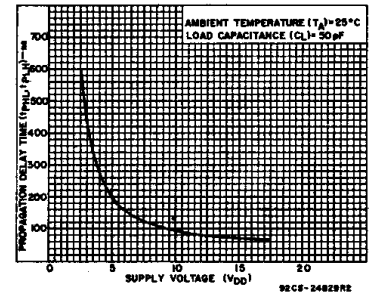

Fig. 10 – Typical propagation delay time vs. supply voltage.

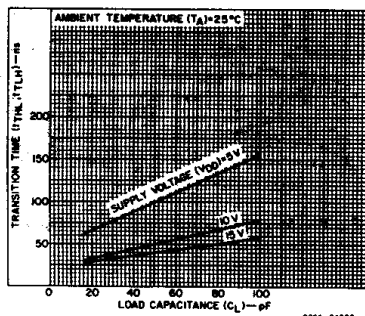

Fig. 11 – Typical transition time vs. load capacitance.

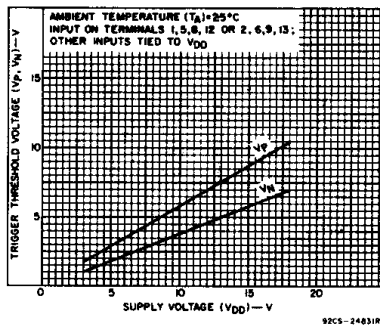

Fig. 12 – Typical trigger threshold voltage vs. V_{DD}

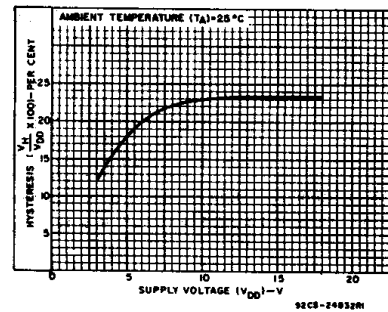

Fig. 13 – Typical per cent hysteresis vs. supply voltage.

CD4093B Types

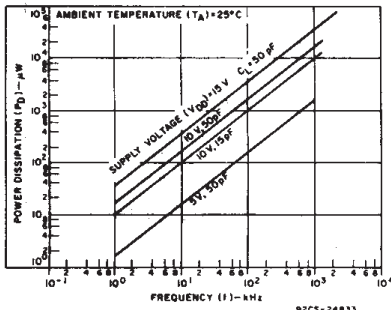

Fig. 14 - Typical power dissipation vs. frequency characteristics.

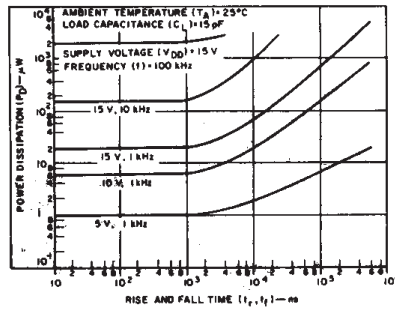

Fig. 15 - Typical power dissipation vs. rise and fall times.

APPLICATIONS

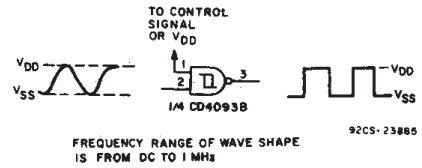

Fig. 16 - Wave shaper.

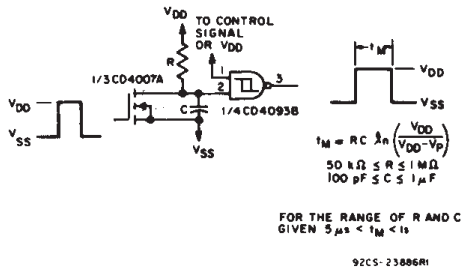

Fig. 17 - Monostable multivibrator.

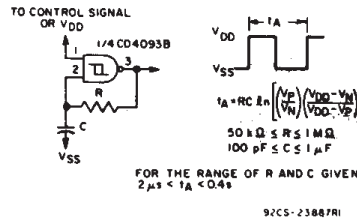

Fig. 18 - Astable multivibrator.

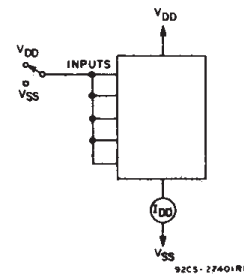

Fig. 19 - Quiescent device current test circuit.

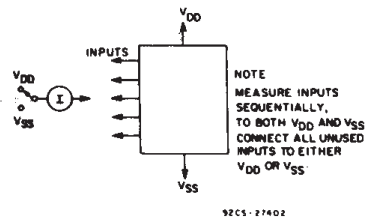
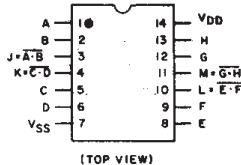

Fig. 20 - Input current test circuit.



TERMINAL ASSIGNMENT

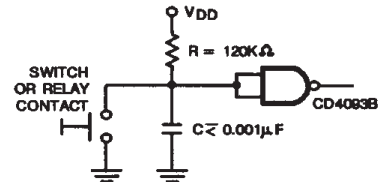

Fig. 21 - Contact Debouncer

PACKAGING INFORMATION

| Orderable Device | Status (1) | Package Type | Package Drawing | Pins | Package Qty | Eco Plan (2) | Lead/Ball Finish (6) | MSL Peak Temp (3) | Op Temp (°C) | Device Marking (4/5) | Samples |
|------------------|---------------|--------------|-----------------|------|-------------|----------------------------|-------------------------|----------------------|--------------|-------------------------|-------------------------|
| 7704602CA | ACTIVE | CDIP | J | 14 | 1 | TBD | A42 | N / A for Pkg Type | -55 to 125 | 7704602CA CD4093BF3A | Samples |
| CD4093BE | ACTIVE | PDIP | N | 14 | 25 | Green (RoHS & no Sb/Br) | CU NIPDAU | N / A for Pkg Type | -55 to 125 | CD4093BE | Samples |
| CD4093BEE4 | ACTIVE | PDIP | N | 14 | 25 | Green (RoHS & no Sb/Br) | CU NIPDAU | N / A for Pkg Type | -55 to 125 | CD4093BE | Samples |
| CD4093BF | ACTIVE | CDIP | J | 14 | 1 | TBD | A42 | N / A for Pkg Type | -55 to 125 | CD4093BF | Samples |
| CD4093BF3A | ACTIVE | CDIP | J | 14 | 1 | TBD | A42 | N / A for Pkg Type | -55 to 125 | 7704602CA CD4093BF3A | Samples |
| CD4093BM | ACTIVE | SOIC | D | 14 | 50 | Green (RoHS & no Sb/Br) | CU NIPDAU | Level-1-260C-UNLIM | -55 to 125 | CD4093BM | Samples |
| CD4093BM96 | ACTIVE | SOIC | D | 14 | 2500 | Green (RoHS & no Sb/Br) | CU NIPDAU | Level-1-260C-UNLIM | -55 to 125 | CD4093BM | Samples |
| CD4093BM96E4 | ACTIVE | SOIC | D | 14 | 2500 | Green (RoHS & no Sb/Br) | CU NIPDAU | Level-1-260C-UNLIM | -55 to 125 | CD4093BM | Samples |
| CD4093BM96G4 | ACTIVE | SOIC | D | 14 | 2500 | Green (RoHS & no Sb/Br) | CU NIPDAU | Level-1-260C-UNLIM | -55 to 125 | CD4093BM | Samples |
| CD4093BMG4 | ACTIVE | SOIC | D | 14 | 50 | Green (RoHS & no Sb/Br) | CU NIPDAU | Level-1-260C-UNLIM | -55 to 125 | CD4093BM | Samples |
| CD4093BMT | ACTIVE | SOIC | D | 14 | 250 | Green (RoHS & no Sb/Br) | CU NIPDAU | Level-1-260C-UNLIM | -55 to 125 | CD4093BM | Samples |
| CD4093BNSR | ACTIVE | SO | NS | 14 | 2000 | Green (RoHS & no Sb/Br) | CU NIPDAU | Level-1-260C-UNLIM | -55 to 125 | CD4093B | Samples |
| CD4093BNSRG4 | ACTIVE | SO | NS | 14 | 2000 | Green (RoHS & no Sb/Br) | CU NIPDAU | Level-1-260C-UNLIM | -55 to 125 | CD4093B | Samples |
| CD4093BPW | ACTIVE | TSSOP | PW | 14 | 90 | Green (RoHS & no Sb/Br) | CU NIPDAU | Level-1-260C-UNLIM | -55 to 125 | CM093B | Samples |
| CD4093BPWR | ACTIVE | TSSOP | PW | 14 | 2000 | Green (RoHS & no Sb/Br) | CU NIPDAU | Level-1-260C-UNLIM | -55 to 125 | CM093B | Samples |

(1) The marketing status values are defined as follows:

ACTIVE: Product device recommended for new designs.

LIFEBUY: TI has announced that the device will be discontinued, and a lifetime-buy period is in effect.

NRND: Not recommended for new designs. Device is in production to support existing customers, but TI does not recommend using this part in a new design.

PREVIEW: Device has been announced but is not in production. Samples may or may not be available.

OBSOLETE: TI has discontinued the production of the device.

(2) **RoHS:** TI defines "RoHS" to mean semiconductor products that are compliant with the current EU RoHS requirements for all 10 RoHS substances, including the requirement that RoHS substance do not exceed 0.1% by weight in homogeneous materials. Where designed to be soldered at high temperatures, "RoHS" products are suitable for use in specified lead-free processes. TI may reference these types of products as "Pb-Free".

RoHS Exempt: TI defines "RoHS Exempt" to mean products that contain lead but are compliant with EU RoHS pursuant to a specific EU RoHS exemption.

Green: TI defines "Green" to mean the content of Chlorine (Cl) and Bromine (Br) based flame retardants meet JS709B low halogen requirements of ≤ 1000 ppm threshold. Antimony trioxide based flame retardants must also meet the ≤ 1000 ppm threshold requirement.

(3) **MSL, Peak Temp.** - The Moisture Sensitivity Level rating according to the JEDEC industry standard classifications, and peak solder temperature.

(4) There may be additional marking, which relates to the logo, the lot trace code information, or the environmental category on the device.

(5) Multiple Device Markings will be inside parentheses. Only one Device Marking contained in parentheses and separated by a "~" will appear on a device. If a line is indented then it is a continuation of the previous line and the two combined represent the entire Device Marking for that device.

(6) **Lead/Ball Finish** - Orderable Devices may have multiple material finish options. Finish options are separated by a vertical ruled line. Lead/Ball Finish values may wrap to two lines if the finish value exceeds the maximum column width.

Important Information and Disclaimer: The information provided on this page represents TI's knowledge and belief as of the date that it is provided. TI bases its knowledge and belief on information provided by third parties, and makes no representation or warranty as to the accuracy of such information. Efforts are underway to better integrate information from third parties. TI has taken and continues to take reasonable steps to provide representative and accurate information but may not have conducted destructive testing or chemical analysis on incoming materials and chemicals. TI and TI suppliers consider certain information to be proprietary, and thus CAS numbers and other limited information may not be available for release.

In no event shall TI's liability arising out of such information exceed the total purchase price of the TI part(s) at issue in this document sold by TI to Customer on an annual basis.

OTHER QUALIFIED VERSIONS OF CD4093B, CD4093B-MIL :

- Catalog: [CD4093B](#)

- Automotive: [CD4093B-Q1](#), [CD4093B-Q1](#)

- Military: [CD4093B-MIL](#)

NOTE: Qualified Version Definitions:

- Catalog - TI's standard catalog product

- Automotive - Q100 devices qualified for high-reliability automotive applications targeting zero defects
- Military - QML certified for Military and Defense Applications

TAPE AND REEL INFORMATION

QUADRANT ASSIGNMENTS FOR PIN 1 ORIENTATION IN TAPE

*All dimensions are nominal

| Device | Package Type | Package Drawing | Pins | SPQ | Reel Diameter (mm) | Reel Width W1 (mm) | A0 (mm) | B0 (mm) | K0 (mm) | P1 (mm) | W (mm) | Pin1 Quadrant |
|------------|--------------|-----------------|------|------|--------------------|--------------------|---------|---------|---------|---------|--------|---------------|
| CD4093BM96 | SOIC | D | 14 | 2500 | 330.0 | 16.4 | 6.5 | 9.0 | 2.1 | 8.0 | 16.0 | Q1 |
| CD4093BMT | SOIC | D | 14 | 250 | 330.0 | 16.4 | 6.5 | 9.0 | 2.1 | 8.0 | 16.0 | Q1 |
| CD4093BNSR | SO | NS | 14 | 2000 | 330.0 | 16.4 | 8.1 | 10.4 | 2.5 | 12.0 | 16.0 | Q1 |
| CD4093BPWR | TSSOP | PW | 14 | 2000 | 330.0 | 12.4 | 6.9 | 5.6 | 1.6 | 8.0 | 12.0 | Q1 |

TAPE AND REEL BOX DIMENSIONS



*All dimensions are nominal

| Device | Package Type | Package Drawing | Pins | SPQ | Length (mm) | Width (mm) | Height (mm) |
|------------|--------------|-----------------|------|------|-------------|------------|-------------|
| CD4093BM96 | SOIC | D | 14 | 2500 | 367.0 | 367.0 | 38.0 |
| CD4093BMT | SOIC | D | 14 | 250 | 210.0 | 185.0 | 35.0 |
| CD4093BNSR | SO | NS | 14 | 2000 | 367.0 | 367.0 | 38.0 |
| CD4093BPWR | TSSOP | PW | 14 | 2000 | 367.0 | 367.0 | 35.0 |

MECHANICAL DATA

NS (R-PDSO-G**)

PLASTIC SMALL-OUTLINE PACKAGE

14-PINS SHOWN



- NOTES:
- A. All linear dimensions are in millimeters.
 - B. This drawing is subject to change without notice.
 - C. Body dimensions do not include mold flash or protrusion, not to exceed 0,15.

J 14

GENERIC PACKAGE VIEW
CDIP - 5.08 mm max height
CERAMIC DUAL IN LINE PACKAGE



Images above are just a representation of the package family, actual package may vary.
Refer to the product data sheet for package details.

4040083-5/G

J0014A



PACKAGE OUTLINE

CDIP - 5.08 mm max height

CERAMIC DUAL IN LINE PACKAGE



4214771/A 05/2017

NOTES:

1. All controlling linear dimensions are in inches. Dimensions in brackets are in millimeters. Any dimension in brackets or parenthesis are for reference only. Dimensioning and tolerancing per ASME Y14.5M.
2. This drawing is subject to change without notice.
3. This package is hermetically sealed with a ceramic lid using glass frit.
4. Index point is provided on cap for terminal identification only and on press ceramic glass frit seal only.
5. Falls within MIL-STD-1835 and GDIP1-T14.

EXAMPLE BOARD LAYOUT

J0014A

CDIP - 5.08 mm max height

CERAMIC DUAL IN LINE PACKAGE



LAND PATTERN EXAMPLE
NON-SOLDER MASK DEFINED
SCALE: 5X



4214771/A 05/2017

D (R-PDSO-G14)

PLASTIC SMALL OUTLINE



- NOTES:
- A. All linear dimensions are in inches (millimeters).
 - B. This drawing is subject to change without notice.
 -  Body length does not include mold flash, protrusions, or gate burrs. Mold flash, protrusions, or gate burrs shall not exceed 0.006 (0,15) each side.
 -  Body width does not include interlead flash. Interlead flash shall not exceed 0.017 (0,43) each side.
 - E. Reference JEDEC MS-012 variation AB.

D (R-PDSO-G14)

PLASTIC SMALL OUTLINE



4211283-3/E 08/12

- NOTES:
- All linear dimensions are in millimeters.
 - This drawing is subject to change without notice.
 - Publication IPC-7351 is recommended for alternate designs.
 - Laser cutting apertures with trapezoidal walls and also rounding corners will offer better paste release. Customers should contact their board assembly site for stencil design recommendations. Refer to IPC-7525 for other stencil recommendations.
 - Customers should contact their board fabrication site for solder mask tolerances between and around signal pads.

PW (R-PDSO-G14)

PLASTIC SMALL OUTLINE



4040064-3/G 02/11

- NOTES:
- A. All linear dimensions are in millimeters. Dimensioning and tolerancing per ASME Y14.5M-1994.
 - B. This drawing is subject to change without notice.
 - C. Body length does not include mold flash, protrusions, or gate burrs. Mold flash, protrusions, or gate burrs shall not exceed 0,15 each side.
 - D. Body width does not include interlead flash. Interlead flash shall not exceed 0,25 each side.
 - E. Falls within JEDEC MO-153

PW (R-PDSO-G14)

PLASTIC SMALL OUTLINE



4211284-2/G 08/15

- NOTES:
- All linear dimensions are in millimeters.
 - This drawing is subject to change without notice.
 - Publication IPC-7351 is recommended for alternate designs.
 - Laser cutting apertures with trapezoidal walls and also rounding corners will offer better paste release. Customers should contact their board assembly site for stencil design recommendations. Refer to IPC-7525 for other stencil recommendations.
 - Customers should contact their board fabrication site for solder mask tolerances between and around signal pads.

N (R-PDIP-T**)

PLASTIC DUAL-IN-LINE PACKAGE

16 PINS SHOWN



- NOTES:
- A. All linear dimensions are in inches (millimeters).
 - B. This drawing is subject to change without notice.
 - Falls within JEDEC MS-001, except 18 and 20 pin minimum body length (Dim A).
 - The 20 pin end lead shoulder width is a vendor option, either half or full width.

IMPORTANT NOTICE AND DISCLAIMER

TI PROVIDES TECHNICAL AND RELIABILITY DATA (INCLUDING DATASHEETS), DESIGN RESOURCES (INCLUDING REFERENCE DESIGNS), APPLICATION OR OTHER DESIGN ADVICE, WEB TOOLS, SAFETY INFORMATION, AND OTHER RESOURCES "AS IS" AND WITH ALL FAULTS, AND DISCLAIMS ALL WARRANTIES, EXPRESS AND IMPLIED, INCLUDING WITHOUT LIMITATION ANY IMPLIED WARRANTIES OF MERCHANTABILITY, FITNESS FOR A PARTICULAR PURPOSE OR NON-INFRINGEMENT OF THIRD PARTY INTELLECTUAL PROPERTY RIGHTS.

These resources are intended for skilled developers designing with TI products. You are solely responsible for (1) selecting the appropriate TI products for your application, (2) designing, validating and testing your application, and (3) ensuring your application meets applicable standards, and any other safety, security, or other requirements. These resources are subject to change without notice. TI grants you permission to use these resources only for development of an application that uses the TI products described in the resource. Other reproduction and display of these resources is prohibited. No license is granted to any other TI intellectual property right or to any third party intellectual property right. TI disclaims responsibility for, and you will fully indemnify TI and its representatives against, any claims, damages, costs, losses, and liabilities arising out of your use of these resources.

TI's products are provided subject to TI's Terms of Sale (www.ti.com/legal/termsofsale.html) or other applicable terms available either on ti.com or provided in conjunction with such TI products. TI's provision of these resources does not expand or otherwise alter TI's applicable warranties or warranty disclaimers for TI products.

Mailing Address: Texas Instruments, Post Office Box 655303, Dallas, Texas 75265
Copyright © 2018, Texas Instruments Incorporated

Looking for pricing, stock, or lifecycle information?

Click below to explore more details on WIN SOURCE:

 [View CD4093BM](#) on WIN SOURCE

 [Texas Instruments](#) Information

Optimize Your Supply Chain with WIN SOURCE Solutions

-  Global Sourcing Solution
-  Obsolete Management
-  Cost Control Management
-  Shortage Management
-  Alternative Solution
-  Excess Inventory Management