



# THE DATASHEET OF CD74HC244M



# CD54/74HC240, CD54/74HCT240, CD74HC241, CD54/74HCT241, CD54/74HC244, CD54/74HCT244

## High-Speed CMOS Logic Octal Buffer/Line Drivers, Three-State

### Features

- HC/HCT240 Inverting
- HC/HCT241 Non-Inverting
- HC/HCT244 Non-Inverting
- Typical Propagation Delay = 8ns at  $V_{CC} = 5V$ ,  $C_L = 15pF$ ,  $T_A = 25^\circ C$  for HC240
- Three-State Outputs
- Buffered Inputs
- High-Current Bus Driver Outputs
- Fanout (Over Temperature Range)
  - Standard Outputs . . . . . 10 LSTTL Loads
  - Bus Driver Outputs . . . . . 15 LSTTL Loads
- Wide Operating Temperature Range . . .  $-55^\circ C$  to  $125^\circ C$
- Balanced Propagation Delay and Transition Times
- Significant Power Reduction Compared to LSTTL Logic ICs
- HC Types
  - 2V to 6V Operation
  - High Noise Immunity:  $N_{IL} = 30\%$ ,  $N_{IH} = 30\%$  of  $V_{CC}$  at  $V_{CC} = 5V$
- HCT Types
  - 4.5V to 5.5V Operation
  - Direct LSTTL Input Logic Compatibility,  $V_{IL} = 0.8V$  (Max),  $V_{IH} = 2V$  (Min)
  - CMOS Input Compatibility,  $I_I \leq 1\mu A$  at  $V_{OL}$ ,  $V_{OH}$

### Description

The 'HC240 and 'HCT240 are inverting three-state buffers having two active-low output enables. The CD74HC241, 'HCT241, 'HC244 and 'HCT244 are non-inverting three-state buffers that differ only in that the 241 has one active-high and one active-low output enable, and the 244 has two active-low output enables. All three types have identical pinouts.

### Ordering Information

PART NUMBER	TEMP. RANGE (°C)	PACKAGE
CD54HC240F3A	-55 to 125	20 Ld CERDIP
CD54HC244F3A	-55 to 125	20 Ld CERDIP
CD54HCT240F3A	-55 to 125	20 Ld CERDIP
CD54HCT241F3A	-55 to 125	20 Ld CERDIP
CD54HCT244F3A	-55 to 125	20 Ld CERDIP
CD74HC240E	-55 to 125	20 Ld PDIP
CD74HC240M	-55 to 125	20 Ld SOIC
CD74HC240M96	-55 to 125	20 Ld SOIC
CD74HC241E	-55 to 125	20 Ld PDIP
CD74HC241M	-55 to 125	20 Ld SOIC
CD74HC241M96	-55 to 125	20 Ld SOIC
CD74HC244E	-55 to 125	20 Ld PDIP
CD74HC244M	-55 to 125	20 Ld SOIC
CD74HC244M96	-55 to 125	20 Ld SOIC
CD74HCT240E	-55 to 125	20 Ld PDIP
CD74HCT240M	-55 to 125	20 Ld SOIC
CD74HCT240M96	-55 to 125	20 Ld SOIC
CD74HCT240PW	-55 to 125	20 Ld TSSOP
CD74HCT240PWR	-55 to 125	20 Ld TSSOP
CD74HCT240PWT	-55 to 125	20 Ld TSSOP
CD74HCT241E	-55 to 125	20 Ld PDIP
CD74HCT241M	-55 to 125	20 Ld SOIC
CD74HCT241M96	-55 to 125	20 Ld SOIC
CD74HCT244E	-55 to 125	20 Ld PDIP
CD74HCT244M	-55 to 125	20 Ld SOIC
CD74HCT244M96	-55 to 125	20 Ld SOIC

NOTE: When ordering, use the entire part number. The suffixes 96 and R denote tape and reel. The suffix T denotes a small-quantity reel of 250.

**Pinout**

CD54HC240, CD54HCT240, CD54HCT241,  
CD54HC244, CD54HCT244  
(CERDIP)

CD74HC240, CD74HC241, CD74HCT241,  
CD74HC244, CD74HCT244  
(PDIP, SOIC)

CD74HCT240,  
(PDIP, SOIC, TSSOP)

TOP VIEW

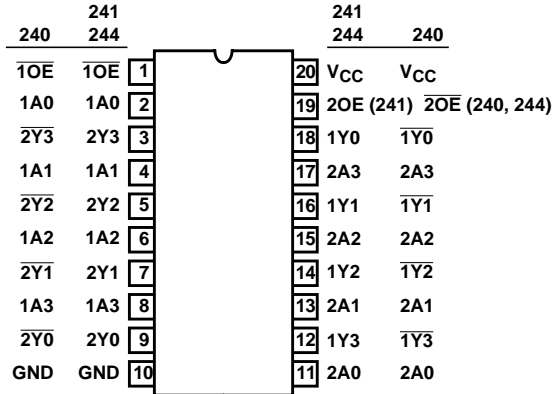

**Functional Diagram**

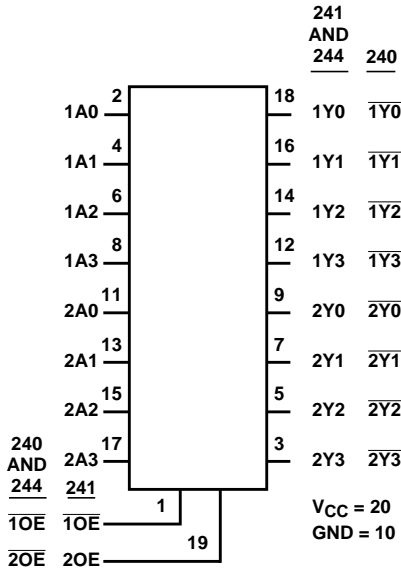

**Absolute Maximum Ratings**

DC Supply Voltage,  $V_{CC}$  ..... -0.5V to 7V  
 DC Input Diode Current,  $I_{IK}$   
 For  $V_I < -0.5V$  or  $V_I > V_{CC} + 0.5V$  .....  $\pm 20mA$   
 DC Output Diode Current,  $I_{OK}$   
 For  $V_O < -0.5V$  or  $V_O > V_{CC} + 0.5V$  .....  $\pm 20mA$   
 DC Drain Current, per Output,  $I_O$   
 For  $-0.5V < V_O < V_{CC} + 0.5V$  .....  $\pm 35mA$   
 DC Output Source or Sink Current per Output Pin,  $I_O$   
 For  $V_O > -0.5V$  or  $V_O < V_{CC} + 0.5V$  .....  $\pm 25mA$   
 DC  $V_{CC}$  or Ground Current,  $I_{CC}$  .....  $\pm 70mA$

**Thermal Information**

Thermal Resistance (Typical, Note 1)  $\theta_{JA}$   
 E (PDIP) Package ..... 69°C/W  
 M (SOIC) Package ..... 58°C/W  
 PW (TSSOP) Package ..... 83°C/W  
 Maximum Junction Temperature ..... 150°C  
 Maximum Storage Temperature Range ..... -65°C to 150°C  
 Maximum Lead Temperature (Soldering 10s) ..... 300°C  
 (SOIC - Lead Tips Only)

**Operating Conditions**

Temperature Range ( $T_A$ ) ..... -55°C to 125°C  
 Supply Voltage Range,  $V_{CC}$   
 HC Types ..... 2V to 6V  
 HCT Types ..... 4.5V to 5.5V  
 DC Input or Output Voltage,  $V_I, V_O$  ..... 0V to  $V_{CC}$   
 Input Rise and Fall Time  
 2V ..... 1000ns (Max)  
 4.5V ..... 500ns (Max)  
 6V ..... 400ns (Max)

CAUTION: Stresses above those listed in "Absolute Maximum Ratings" may cause permanent damage to the device. This is a stress only rating and operation of the device at these or any other conditions above those indicated in the operational sections of this specification is not implied.

NOTE:

1. The package thermal impedance is calculated in accordance with JESD 51-7.

**DC Electrical Specifications**

PARAMETER	SYMBOL	TEST CONDITIONS		$V_{CC}$ (V)	25°C			-40°C TO 85°C		-55°C TO 125°C		UNITS
		$V_I$ (V)	$I_O$ (mA)		MIN	TYP	MAX	MIN	MAX	MIN	MAX	
<b>HC TYPES</b>												
High Level Input Voltage	$V_{IH}$	-	-	2	1.5	-	-	1.5	-	1.5	-	V
				4.5	3.15	-	-	3.15	-	3.15	-	V
				6	4.2	-	-	4.2	-	4.2	-	V
Low Level Input Voltage	$V_{IL}$	-	-	2	-	-	0.5	-	0.5	-	0.5	V
				4.5	-	-	1.35	-	1.35	-	1.35	V
				6	-	-	1.8	-	1.8	-	1.8	V
High Level Output Voltage CMOS Loads	$V_{OH}$	$V_{IH}$ or $V_{IL}$	-0.02	2	1.9	-	-	1.9	-	1.9	-	V
			-0.02	4.5	4.4	-	-	4.4	-	4.4	-	V
			-0.02	6	5.9	-	-	5.9	-	5.9	-	V
High Level Output Voltage TTL Loads	$V_{OH}$	$V_{IH}$ or $V_{IL}$	-6	4.5	3.98	-	-	3.84	-	3.7	-	V
			-7.8	6	5.48	-	-	5.34	-	5.2	-	V
Low Level Output Voltage CMOS Loads	$V_{OL}$	$V_{IH}$ or $V_{IL}$	0.02	2	-	-	0.1	-	0.1	-	0.1	V
			0.02	4.5	-	-	0.1	-	0.1	-	0.1	V
			0.02	6	-	-	0.1	-	0.1	-	0.1	V
Low Level Output Voltage TTL Loads	$V_{OL}$	$V_{IH}$ or $V_{IL}$	6	4.5	-	-	0.26	-	0.33	-	0.4	V
			7.8	6	-	-	0.26	-	0.33	-	0.4	V
Input Leakage Current	$I_I$	$V_{CC}$ or GND	-	6	-	-	$\pm 0.1$	-	$\pm 1$	-	$\pm 1$	$\mu A$
Quiescent Device Current	$I_{CC}$	$V_{CC}$ or GND	0	6	-	-	8	-	80	-	160	$\mu A$

**DC Electrical Specifications (Continued)**

PARAMETER	SYMBOL	TEST CONDITIONS		V <sub>CC</sub> (V)	25°C			-40°C TO 85°C		-55°C TO 125°C		UNITS
		V <sub>I</sub> (V)	I <sub>O</sub> (mA)		MIN	TYP	MAX	MIN	MAX	MIN	MAX	
Three-State Leakage Current	I <sub>OZ</sub>	V <sub>IL</sub> or V <sub>IH</sub>	-	6	-	-	±0.5	-	±0.5	-	±10	µA
<b>HCT TYPES</b>												
High Level Input Voltage	V <sub>IH</sub>	-	-	4.5 to 5.5	2	-	-	2	-	2	-	V
Low Level Input Voltage	V <sub>IL</sub>	-	-	4.5 to 5.5	-	-	0.8	-	0.8	-	0.8	V
High Level Output Voltage CMOS Loads	V <sub>OH</sub>	V <sub>IH</sub> or V <sub>IL</sub>	-0.02	4.5	4.4	-	-	4.4	-	4.4	-	V
High Level Output Voltage TTL Loads			-6	4.5	3.98	-	-	3.84	-	3.7	-	V
Low Level Output Voltage CMOS Loads	V <sub>OL</sub>	V <sub>IH</sub> or V <sub>IL</sub>	0.02	4.5	-	-	0.1	-	0.1	-	0.1	V
Low Level Output Voltage TTL Loads			6	4.5	-	-	0.26	-	0.33	-	0.4	V
Input Leakage Current	I <sub>I</sub>	V <sub>CC</sub> to GND	0	5.5	-	-	±0.1	-	±1	-	±1	µA
Quiescent Device Current	I <sub>CC</sub>	V <sub>CC</sub> or GND	0	5.5	-	-	8	-	80	-	160	µA
Additional Quiescent Device Current Per Input Pin: 1 Unit Load	ΔI <sub>CC</sub> (Note 2)	V <sub>CC</sub> -2.1	-	4.5 to 5.5	-	100	360	-	450	-	490	µA
Three-State Leakage Current	I <sub>OZ</sub>	V <sub>IL</sub> or V <sub>IH</sub>	-	5.5	-	-	±0.5	-	±5	-	±10	µA

NOTE:

2. For dual-supply systems theoretical worst case (V<sub>I</sub> = 2.4V, V<sub>CC</sub> = 5.5V) specification is 1.8mA.

**HCT Input Loading Table**

INPUT	UNIT LOADS
<b>HCT240</b>	
nA0-A3	1.5
$\overline{1}OE$	0.7
$\overline{2}OE$	0.7
<b>HCT241</b>	
nA0-A3	0.7
$\overline{1}OE$	0.7
$\overline{2}OE$	1.5
<b>HCT244</b>	
nA0-A3	0.7
$\overline{1}OE$	0.7
$\overline{2}OE$	0.7

NOTE: Unit Load is ΔI<sub>CC</sub> limit specified in DC Electrical Specifications table, e.g., 360µA max at 25°C.

**CD54/74HC240, CD54/74HCT240, CD74HC241, CD54/74HCT241, CD54/74HC244, CD54/74HCT244**

**Switching Specifications**  $C_L = 50\text{pF}$ , Input  $t_r, t_f = 6\text{ns}$

PARAMETER	SYMBOL	TEST CONDITIONS	V <sub>CC</sub> (V)	25°C			-40°C TO 85°C			-55°C TO 125°C			UNITS
				MIN	TYP	MAX	MIN	TYP	MAX	MIN	TYP	MAX	
<b>HC TYPES</b>													
Propagation Delay Data to Outputs HC240	$t_{PLH}, t_{PHL}$	$C_L = 50\text{pF}$	2	-	-	100	-	-	125	-	-	150	ns
			4.5	-	-	20	-	-	25	-	-	30	ns
		$C_L = 15\text{pF}$	5	-	8	-	-	-	-	-	-	-	ns
		$C_L = 50\text{pF}$	6	-	-	17	-	-	21	-	-	26	ns
Data to Outputs HC241	$t_{PLH}, t_{PHL}$	$C_L = 50\text{pF}$	2	-	-	110	-	-	140	-	-	165	ns
			4.5	-	-	22	-	-	28	-	-	33	ns
		$C_L = 15\text{pF}$	5	-	9	-	-	-	-	-	-	-	ns
		$C_L = 50\text{pF}$	6	-	-	19	-	-	24	-	-	28	ns
Data to Outputs HC244	$t_{PLH}, t_{PHL}$	$C_L = 50\text{pF}$	2	-	-	110	-	-	140	-	-	165	ns
			4.5	-	-	22	-	-	28	-	-	33	ns
		$C_L = 15\text{pF}$	5	-	9	-	-	-	-	-	-	-	ns
		$C_L = 50\text{pF}$	6	-	-	19	-	-	24	-	-	28	ns
Output Enable and Disable Time	$t_{THL}, t_{TLH}$	$C_L = 50\text{pF}$	2	-	-	150	-	-	190	-	-	225	ns
			4.5	-	-	30	-	-	38	-	-	45	ns
		5	-	12	-	-	-	-	-	-	-	-	ns
		6	-	-	26	-	-	33	-	-	38	ns	
Output Transition Time	$t_{TLH}, t_{THL}$	$C_L = 50\text{pF}$	2	-	-	60	-	-	75	-	-	90	ns
			4.5	-	-	12	-	-	15	-	-	18	ns
			6	-	-	10	-	-	13	-	-	15	ns
Input Capacitance	$C_I$	$C_L = 50\text{pF}$	-	10	-	10	-	-	10	-	-	10	pF
Three-State Output Capacitance	$C_O$	$C_L = 50\text{pF}$	-	-	-	20	-	-	20	-	-	20	pF
Power Dissipation Capacitance (Notes 3, 4)	$C_{PD}$	$C_L = 15\text{pF}$	5	-	38	-	-	-	-	-	-	-	pF
			5	-	34	-	-	-	-	-	-	-	pF
			5	-	46	-	-	-	-	-	-	-	pF
<b>HCT TYPES</b>													
Propagation Delay Data to Outputs HCT240	$t_{PHL}, t_{PLH}$	$C_L = 50\text{pF}$	4.5	-	-	22	-	-	28	-	-	33	ns
		$C_L = 15\text{pF}$	5	-	9	-	-	-	-	-	-	-	ns
Data to Outputs HCT241	$t_{PHL}, t_{PLH}$	$C_L = 50\text{pF}$	4.5	-	-	25	-	-	31	-	-	38	ns
		$C_L = 15\text{pF}$	5	-	10	-	-	-	-	-	-	-	ns
Data to Outputs HCT244	$t_{PHL}, t_{PLH}$	$C_L = 50\text{pF}$	4.5	-	-	25	-	-	31	-	-	38	ns
		$C_L = 15\text{pF}$	5	-	10	-	-	-	-	-	-	-	ns

**Switching Specifications**  $C_L = 50\text{pF}$ , Input  $t_r, t_f = 6\text{ns}$  (Continued)

PARAMETER	SYMBOL	TEST CONDITIONS	$V_{CC}$ (V)	25°C			-40°C TO 85°C			-55°C TO 125°C			UNITS
				MIN	TYP	MAX	MIN	TYP	MAX	MIN	TYP	MAX	
Output Enable and Disable Times	$t_{TLH}, t_{TLH}$	$C_L = 50\text{pF}$	4.5	-	-	30	-	-	38	-	-	45	ns
Output Transition Time	$t_{THL}, t_{TLH}$	$C_L = 50\text{pF}$	4.5	-	-	12	-	-	15	-	-	18	ns
Input Capacitance	$C_I$	$C_L = 50\text{pF}$	-	10	-	10	-	-	10	-	-	10	pF
Power Dissipation Capacitance (Notes 3, 4)	$C_{PD}$												
HCT240		-	5	-	40	-	-	-	-	-	-	-	pF
HCT241		-	5	-	38	-	-	-	-	-	-	-	pF
HCT244		-	5	-	40	-	-	-	-	-	-	-	pF

NOTES:

- $C_{PD}$  is used to determine the dynamic power consumption, per channel.
- $P_D = V_{CC}^2 f_i (C_{PD} + C_L)$  where  $f_i$  = Input Frequency,  $f_O$  = Output Frequency,  $C_L$  = Output Load Capacitance,  $V_{CC}$  = Supply Voltage.

**Test Circuits and Waveforms**

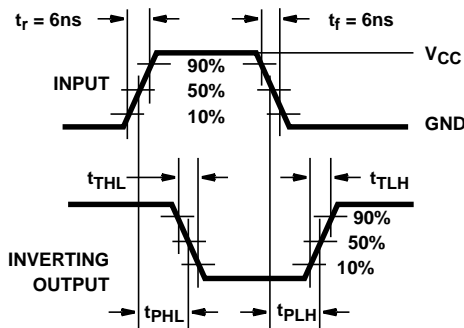

FIGURE 1. HC TRANSITION TIMES AND PROPAGATION DELAY TIMES, COMBINATION LOGIC

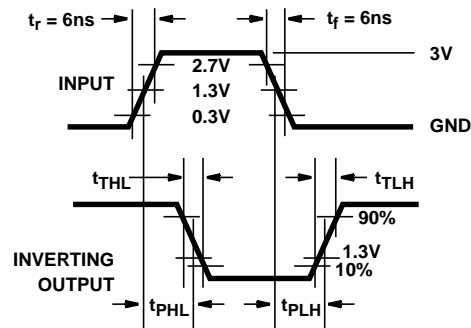

FIGURE 2. HCT TRANSITION TIMES AND PROPAGATION DELAY TIMES, COMBINATION LOGIC

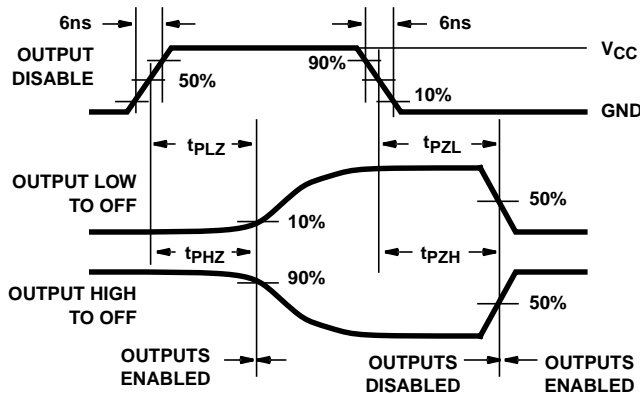

FIGURE 3. HC THREE-STATE PROPAGATION DELAY WAVEFORM

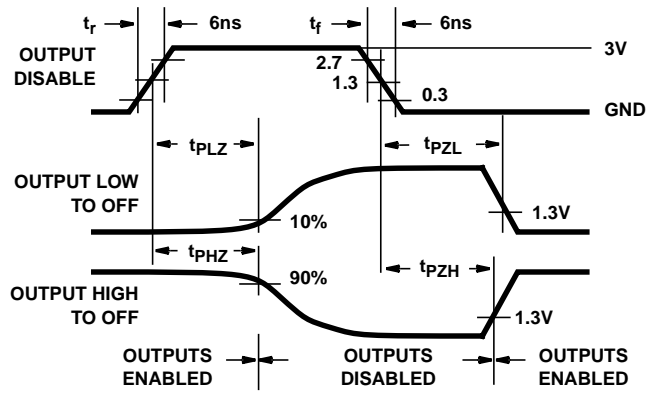
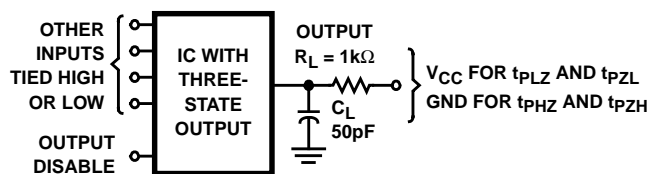

FIGURE 4. HCT THREE-STATE PROPAGATION DELAY WAVEFORM

**Test Circuits and Waveforms** (Continued)





NOTE: Open drain waveforms t<sub>pLZ</sub> and t<sub>pZL</sub> are the same as those for three-state shown on the left. The test circuit is Output R<sub>L</sub> = 1kΩ to V<sub>CC</sub>, C<sub>L</sub> = 50pF.

**FIGURE 5. HC AND HCT THREE-STATE PROPAGATION DELAY TEST CIRCUIT**

**PACKAGING INFORMATION**

Orderable Device	Status (1)	Package Type	Package Drawing	Pins	Package Qty	Eco Plan (2)	Lead/Ball Finish (6)	MSL Peak Temp (3)	Op Temp (°C)	Device Marking (4/5)	Samples
CD54HC240F3A	ACTIVE	CDIP	J	20	1	TBD	A42	N / A for Pkg Type	-55 to 125	8407401RA CD54HC240F3A	<a href="#">Samples</a>
CD54HC244F	ACTIVE	CDIP	J	20	1	TBD	A42	N / A for Pkg Type	-55 to 125	CD54HC244F	<a href="#">Samples</a>
CD54HC244F3A	ACTIVE	CDIP	J	20	1	TBD	A42	N / A for Pkg Type	-55 to 125	8409601RA CD54HC244F3A	<a href="#">Samples</a>
CD54HCT240F3A	ACTIVE	CDIP	J	20	1	TBD	A42	N / A for Pkg Type	-55 to 125	8550501RA CD54HCT240F3A	<a href="#">Samples</a>
CD54HCT241F3A	ACTIVE	CDIP	J	20	1	TBD	A42	N / A for Pkg Type	-55 to 125	CD54HCT241F3A	<a href="#">Samples</a>
CD54HCT244F	ACTIVE	CDIP	J	20	1	TBD	A42	N / A for Pkg Type	-55 to 125	CD54HCT244F	<a href="#">Samples</a>
CD54HCT244F3A	ACTIVE	CDIP	J	20	1	TBD	A42	N / A for Pkg Type	-55 to 125	8513001RA CD54HCT244F3A	<a href="#">Samples</a>
CD74HC240E	ACTIVE	PDIP	N	20	20	Pb-Free (RoHS)	CU NIPDAU	N / A for Pkg Type	-55 to 125	CD74HC240E	<a href="#">Samples</a>
CD74HC240M	ACTIVE	SOIC	DW	20	25	Green (RoHS & no Sb/Br)	CU NIPDAU	Level-1-260C-UNLIM	-55 to 125	HC240M	<a href="#">Samples</a>
CD74HC240M96	ACTIVE	SOIC	DW	20	2000	Green (RoHS & no Sb/Br)	CU NIPDAU	Level-1-260C-UNLIM	-55 to 125	HC240M	<a href="#">Samples</a>
CD74HC241E	ACTIVE	PDIP	N	20	20	Pb-Free (RoHS)	CU NIPDAU	N / A for Pkg Type	-55 to 125	CD74HC241E	<a href="#">Samples</a>
CD74HC241M	ACTIVE	SOIC	DW	20	25	Green (RoHS & no Sb/Br)	CU NIPDAU	Level-1-260C-UNLIM	-55 to 125	HC241M	<a href="#">Samples</a>
CD74HC241M96	ACTIVE	SOIC	DW	20	2000	Green (RoHS & no Sb/Br)	CU NIPDAU	Level-1-260C-UNLIM	-55 to 125	HC241M	<a href="#">Samples</a>
CD74HC241M96E4	ACTIVE	SOIC	DW	20	2000	Green (RoHS & no Sb/Br)	CU NIPDAU	Level-1-260C-UNLIM	-55 to 125	HC241M	<a href="#">Samples</a>
CD74HC241MG4	ACTIVE	SOIC	DW	20	25	Green (RoHS & no Sb/Br)	CU NIPDAU	Level-1-260C-UNLIM	-55 to 125	HC241M	<a href="#">Samples</a>
CD74HC244E	ACTIVE	PDIP	N	20	20	Pb-Free (RoHS)	CU NIPDAU	N / A for Pkg Type	-55 to 125	CD74HC244E	<a href="#">Samples</a>
CD74HC244EE4	ACTIVE	PDIP	N	20	20	Pb-Free (RoHS)	CU NIPDAU	N / A for Pkg Type	-55 to 125	CD74HC244E	<a href="#">Samples</a>

Orderable Device	Status (1)	Package Type	Package Drawing	Pins	Package Qty	Eco Plan (2)	Lead/Ball Finish (6)	MSL Peak Temp (3)	Op Temp (°C)	Device Marking (4/5)	Samples
CD74HC244M	ACTIVE	SOIC	DW	20	25	Green (RoHS & no Sb/Br)	CU NIPDAU	Level-1-260C-UNLIM	-55 to 125	HC244M	<a href="#">Samples</a>
CD74HC244M96	ACTIVE	SOIC	DW	20	2000	Green (RoHS & no Sb/Br)	CU NIPDAU	Level-1-260C-UNLIM	-55 to 125	HC244M	<a href="#">Samples</a>
CD74HC244M96E4	ACTIVE	SOIC	DW	20	2000	Green (RoHS & no Sb/Br)	CU NIPDAU	Level-1-260C-UNLIM	-55 to 125	HC244M	<a href="#">Samples</a>
CD74HC244M96G4	ACTIVE	SOIC	DW	20	2000	Green (RoHS & no Sb/Br)	CU NIPDAU	Level-1-260C-UNLIM	-55 to 125	HC244M	<a href="#">Samples</a>
CD74HCT240E	ACTIVE	PDIP	N	20	20	Pb-Free (RoHS)	CU NIPDAU	N / A for Pkg Type	-55 to 125	CD74HCT240E	<a href="#">Samples</a>
CD74HCT240EE4	ACTIVE	PDIP	N	20	20	Pb-Free (RoHS)	CU NIPDAU	N / A for Pkg Type	-55 to 125	CD74HCT240E	<a href="#">Samples</a>
CD74HCT240M	ACTIVE	SOIC	DW	20	25	Green (RoHS & no Sb/Br)	CU NIPDAU	Level-1-260C-UNLIM	-55 to 125	HCT240M	<a href="#">Samples</a>
CD74HCT240M96	ACTIVE	SOIC	DW	20	2000	Green (RoHS & no Sb/Br)	CU NIPDAU	Level-1-260C-UNLIM	-55 to 125	HCT240M	<a href="#">Samples</a>
CD74HCT240MG4	ACTIVE	SOIC	DW	20	25	Green (RoHS & no Sb/Br)	CU NIPDAU	Level-1-260C-UNLIM	-55 to 125	HCT240M	<a href="#">Samples</a>
CD74HCT240PW	ACTIVE	TSSOP	PW	20	70	Green (RoHS & no Sb/Br)	CU NIPDAU	Level-1-260C-UNLIM	-55 to 125	HK240	<a href="#">Samples</a>
CD74HCT240PWR	ACTIVE	TSSOP	PW	20	2000	Green (RoHS & no Sb/Br)	CU NIPDAU	Level-1-260C-UNLIM	-55 to 125	HK240	<a href="#">Samples</a>
CD74HCT240PWT	ACTIVE	TSSOP	PW	20	250	Green (RoHS & no Sb/Br)	CU NIPDAU	Level-1-260C-UNLIM	-55 to 125	HK240	<a href="#">Samples</a>
CD74HCT241E	ACTIVE	PDIP	N	20	20	Pb-Free (RoHS)	CU NIPDAU	N / A for Pkg Type	-55 to 125	CD74HCT241E	<a href="#">Samples</a>
CD74HCT241EE4	ACTIVE	PDIP	N	20	20	Pb-Free (RoHS)	CU NIPDAU	N / A for Pkg Type	-55 to 125	CD74HCT241E	<a href="#">Samples</a>
CD74HCT241M	ACTIVE	SOIC	DW	20	25	Green (RoHS & no Sb/Br)	CU NIPDAU	Level-1-260C-UNLIM	-55 to 125	HCT241M	<a href="#">Samples</a>
CD74HCT241M96	ACTIVE	SOIC	DW	20	2000	Green (RoHS & no Sb/Br)	CU NIPDAU	Level-1-260C-UNLIM	-55 to 125	HCT241M	<a href="#">Samples</a>
CD74HCT244E	ACTIVE	PDIP	N	20	20	Pb-Free (RoHS)	CU NIPDAU	N / A for Pkg Type	-55 to 125	CD74HCT244E	<a href="#">Samples</a>
CD74HCT244M	ACTIVE	SOIC	DW	20	25	Green (RoHS & no Sb/Br)	CU NIPDAU	Level-1-260C-UNLIM	-55 to 125	HCT244M	<a href="#">Samples</a>

Orderable Device	Status (1)	Package Type	Package Drawing	Pins	Package Qty	Eco Plan (2)	Lead/Ball Finish (6)	MSL Peak Temp (3)	Op Temp (°C)	Device Marking (4/5)	Samples
CD74HCT244M96	ACTIVE	SOIC	DW	20	2000	Green (RoHS & no Sb/Br)	CU NIPDAU	Level-1-260C-UNLIM	-55 to 125	HCT244M	
CD74HCT244ME4	ACTIVE	SOIC	DW	20	25	Green (RoHS & no Sb/Br)	CU NIPDAU	Level-1-260C-UNLIM	-55 to 125	HCT244M	

(1) The marketing status values are defined as follows:

**ACTIVE:** Product device recommended for new designs.

**LIFEBUY:** TI has announced that the device will be discontinued, and a lifetime-buy period is in effect.

**NRND:** Not recommended for new designs. Device is in production to support existing customers, but TI does not recommend using this part in a new design.

**PREVIEW:** Device has been announced but is not in production. Samples may or may not be available.

**OBSOLETE:** TI has discontinued the production of the device.

(2) **RoHS:** TI defines "RoHS" to mean semiconductor products that are compliant with the current EU RoHS requirements for all 10 RoHS substances, including the requirement that RoHS substance do not exceed 0.1% by weight in homogeneous materials. Where designed to be soldered at high temperatures, "RoHS" products are suitable for use in specified lead-free processes. TI may reference these types of products as "Pb-Free".

**RoHS Exempt:** TI defines "RoHS Exempt" to mean products that contain lead but are compliant with EU RoHS pursuant to a specific EU RoHS exemption.

**Green:** TI defines "Green" to mean the content of Chlorine (Cl) and Bromine (Br) based flame retardants meet JS709B low halogen requirements of <=1000ppm threshold. Antimony trioxide based flame retardants must also meet the <=1000ppm threshold requirement.

(3) MSL, Peak Temp. - The Moisture Sensitivity Level rating according to the JEDEC industry standard classifications, and peak solder temperature.

(4) There may be additional marking, which relates to the logo, the lot trace code information, or the environmental category on the device.

(5) Multiple Device Markings will be inside parentheses. Only one Device Marking contained in parentheses and separated by a "~" will appear on a device. If a line is indented then it is a continuation of the previous line and the two combined represent the entire Device Marking for that device.

(6) Lead/Ball Finish - Orderable Devices may have multiple material finish options. Finish options are separated by a vertical ruled line. Lead/Ball Finish values may wrap to two lines if the finish value exceeds the maximum column width.

**Important Information and Disclaimer:**The information provided on this page represents TI's knowledge and belief as of the date that it is provided. TI bases its knowledge and belief on information provided by third parties, and makes no representation or warranty as to the accuracy of such information. Efforts are underway to better integrate information from third parties. TI has taken and continues to take reasonable steps to provide representative and accurate information but may not have conducted destructive testing or chemical analysis on incoming materials and chemicals. TI and TI suppliers consider certain information to be proprietary, and thus CAS numbers and other limited information may not be available for release.

In no event shall TI's liability arising out of such information exceed the total purchase price of the TI part(s) at issue in this document sold by TI to Customer on an annual basis.

**OTHER QUALIFIED VERSIONS OF CD54HC240, CD54HC244, CD54HCT240, CD54HCT241, CD54HCT244, CD74HC240, CD74HC244, CD74HCT240, CD74HCT241, CD74HCT244 :**

- Catalog: [CD74HC240](#), [CD74HC244](#), [CD74HCT240](#), [CD74HCT241](#), [CD74HCT244](#)
- Military: [CD54HC240](#), [CD54HC244](#), [CD54HCT240](#), [CD54HCT241](#), [CD54HCT244](#)

NOTE: Qualified Version Definitions:

- Catalog - TI's standard catalog product
- Military - QML certified for Military and Defense Applications

**TAPE AND REEL INFORMATION**
**REEL DIMENSIONS**

**TAPE DIMENSIONS**

A0	Dimension designed to accommodate the component width
B0	Dimension designed to accommodate the component length
K0	Dimension designed to accommodate the component thickness
W	Overall width of the carrier tape
P1	Pitch between successive cavity centers

**TAPE AND REEL INFORMATION**

\*All dimensions are nominal

Device	Package Type	Package Drawing	Pins	SPQ	Reel Diameter (mm)	Reel Width W1 (mm)	A0 (mm)	B0 (mm)	K0 (mm)	P1 (mm)	W (mm)	Pin1 Quadrant
CD74HC240M96	SOIC	DW	20	2000	330.0	24.4	10.8	13.0	2.7	12.0	24.0	Q1
CD74HC241M96	SOIC	DW	20	2000	330.0	24.4	10.8	13.0	2.7	12.0	24.0	Q1
CD74HC244M96	SOIC	DW	20	2000	330.0	24.4	10.8	13.0	2.7	12.0	24.0	Q1
CD74HCT240M96	SOIC	DW	20	2000	330.0	24.4	10.8	13.0	2.7	12.0	24.0	Q1
CD74HCT240PWR	TSSOP	PW	20	2000	330.0	16.4	6.95	7.1	1.6	8.0	16.0	Q1
CD74HCT240PWT	TSSOP	PW	20	250	330.0	16.4	6.95	7.1	1.6	8.0	16.0	Q1
CD74HCT241M96	SOIC	DW	20	2000	330.0	24.4	10.8	13.0	2.7	12.0	24.0	Q1
CD74HCT244M96	SOIC	DW	20	2000	330.0	24.4	10.8	13.0	2.7	12.0	24.0	Q1

**TAPE AND REEL BOX DIMENSIONS**

\*All dimensions are nominal

Device	Package Type	Package Drawing	Pins	SPQ	Length (mm)	Width (mm)	Height (mm)
CD74HC240M96	SOIC	DW	20	2000	367.0	367.0	45.0
CD74HC241M96	SOIC	DW	20	2000	367.0	367.0	45.0
CD74HC244M96	SOIC	DW	20	2000	367.0	367.0	45.0
CD74HCT240M96	SOIC	DW	20	2000	367.0	367.0	45.0
CD74HCT240PWR	TSSOP	PW	20	2000	367.0	367.0	38.0
CD74HCT240PWT	TSSOP	PW	20	250	367.0	367.0	38.0
CD74HCT241M96	SOIC	DW	20	2000	367.0	367.0	45.0
CD74HCT244M96	SOIC	DW	20	2000	367.0	367.0	45.0





PW (R-PDSO-G20)

PLASTIC SMALL OUTLINE



4040064-5/G 02/11

- NOTES:
- A. All linear dimensions are in millimeters. Dimensioning and tolerancing per ASME Y14.5M-1994.
  - B. This drawing is subject to change without notice.
  -  Body length does not include mold flash, protrusions, or gate burrs. Mold flash, protrusions, or gate burrs shall not exceed 0,15 each side.
  -  Body width does not include interlead flash. Interlead flash shall not exceed 0,25 each side.
  - E. Falls within JEDEC MO-153

PW (R-PDSO-G20)

PLASTIC SMALL OUTLINE



- NOTES:
- A. All linear dimensions are in millimeters.
  - B. This drawing is subject to change without notice.
  - C. Publication IPC-7351 is recommended for alternate design.
  - D. Laser cutting apertures with trapezoidal walls and also rounding corners will offer better paste release. Customers should contact their board assembly site for stencil design recommendations. Refer to IPC-7525 for other stencil recommendations.
  - E. Customers should contact their board fabrication site for solder mask tolerances between and around signal pads.

N (R-PDIP-T\*\*)

PLASTIC DUAL-IN-LINE PACKAGE

16 PINS SHOWN



- NOTES:
- A. All linear dimensions are in inches (millimeters).
  - B. This drawing is subject to change without notice.
  - $\triangle C$  Falls within JEDEC MS-001, except 18 and 20 pin minimum body length (Dim A).
  - $\triangle D$  The 20 pin end lead shoulder width is a vendor option, either half or full width.



# EXAMPLE BOARD LAYOUT

DW0020A

SOIC - 2.65 mm max height

SOIC



LAND PATTERN EXAMPLE  
SCALE:6X



SOLDER MASK DETAILS

4220724/A 05/2016

NOTES: (continued)

- 6. Publication IPC-7351 may have alternate designs.
- 7. Solder mask tolerances between and around signal pads can vary based on board fabrication site.

# EXAMPLE STENCIL DESIGN

DW0020A

SOIC - 2.65 mm max height

SOIC



SOLDER PASTE EXAMPLE  
BASED ON 0.125 mm THICK STENCIL  
SCALE:6X

4220724/A 05/2016

NOTES: (continued)

8. Laser cutting apertures with trapezoidal walls and rounded corners may offer better paste release. IPC-7525 may have alternate design recommendations.
9. Board assembly site may have different recommendations for stencil design.

## IMPORTANT NOTICE

Texas Instruments Incorporated (TI) reserves the right to make corrections, enhancements, improvements and other changes to its semiconductor products and services per JESD46, latest issue, and to discontinue any product or service per JESD48, latest issue. Buyers should obtain the latest relevant information before placing orders and should verify that such information is current and complete.

TI's published terms of sale for semiconductor products (<http://www.ti.com/sc/docs/stdterms.htm>) apply to the sale of packaged integrated circuit products that TI has qualified and released to market. Additional terms may apply to the use or sale of other types of TI products and services.

Reproduction of significant portions of TI information in TI data sheets is permissible only if reproduction is without alteration and is accompanied by all associated warranties, conditions, limitations, and notices. TI is not responsible or liable for such reproduced documentation. Information of third parties may be subject to additional restrictions. Resale of TI products or services with statements different from or beyond the parameters stated by TI for that product or service voids all express and any implied warranties for the associated TI product or service and is an unfair and deceptive business practice. TI is not responsible or liable for any such statements.

Buyers and others who are developing systems that incorporate TI products (collectively, "Designers") understand and agree that Designers remain responsible for using their independent analysis, evaluation and judgment in designing their applications and that Designers have full and exclusive responsibility to assure the safety of Designers' applications and compliance of their applications (and of all TI products used in or for Designers' applications) with all applicable regulations, laws and other applicable requirements. Designer represents that, with respect to their applications, Designer has all the necessary expertise to create and implement safeguards that (1) anticipate dangerous consequences of failures, (2) monitor failures and their consequences, and (3) lessen the likelihood of failures that might cause harm and take appropriate actions. Designer agrees that prior to using or distributing any applications that include TI products, Designer will thoroughly test such applications and the functionality of such TI products as used in such applications.

TI's provision of technical, application or other design advice, quality characterization, reliability data or other services or information, including, but not limited to, reference designs and materials relating to evaluation modules, (collectively, "TI Resources") are intended to assist designers who are developing applications that incorporate TI products; by downloading, accessing or using TI Resources in any way, Designer (individually or, if Designer is acting on behalf of a company, Designer's company) agrees to use any particular TI Resource solely for this purpose and subject to the terms of this Notice.

TI's provision of TI Resources does not expand or otherwise alter TI's applicable published warranties or warranty disclaimers for TI products, and no additional obligations or liabilities arise from TI providing such TI Resources. TI reserves the right to make corrections, enhancements, improvements and other changes to its TI Resources. TI has not conducted any testing other than that specifically described in the published documentation for a particular TI Resource.

Designer is authorized to use, copy and modify any individual TI Resource only in connection with the development of applications that include the TI product(s) identified in such TI Resource. NO OTHER LICENSE, EXPRESS OR IMPLIED, BY ESTOPPEL OR OTHERWISE TO ANY OTHER TI INTELLECTUAL PROPERTY RIGHT, AND NO LICENSE TO ANY TECHNOLOGY OR INTELLECTUAL PROPERTY RIGHT OF TI OR ANY THIRD PARTY IS GRANTED HEREIN, including but not limited to any patent right, copyright, mask work right, or other intellectual property right relating to any combination, machine, or process in which TI products or services are used. Information regarding or referencing third-party products or services does not constitute a license to use such products or services, or a warranty or endorsement thereof. Use of TI Resources may require a license from a third party under the patents or other intellectual property of the third party, or a license from TI under the patents or other intellectual property of TI.

TI RESOURCES ARE PROVIDED "AS IS" AND WITH ALL FAULTS. TI DISCLAIMS ALL OTHER WARRANTIES OR REPRESENTATIONS, EXPRESS OR IMPLIED, REGARDING RESOURCES OR USE THEREOF, INCLUDING BUT NOT LIMITED TO ACCURACY OR COMPLETENESS, TITLE, ANY EPIDEMIC FAILURE WARRANTY AND ANY IMPLIED WARRANTIES OF MERCHANTABILITY, FITNESS FOR A PARTICULAR PURPOSE, AND NON-INFRINGEMENT OF ANY THIRD PARTY INTELLECTUAL PROPERTY RIGHTS. TI SHALL NOT BE LIABLE FOR AND SHALL NOT DEFEND OR INDEMNIFY DESIGNER AGAINST ANY CLAIM, INCLUDING BUT NOT LIMITED TO ANY INFRINGEMENT CLAIM THAT RELATES TO OR IS BASED ON ANY COMBINATION OF PRODUCTS EVEN IF DESCRIBED IN TI RESOURCES OR OTHERWISE. IN NO EVENT SHALL TI BE LIABLE FOR ANY ACTUAL, DIRECT, SPECIAL, COLLATERAL, INDIRECT, PUNITIVE, INCIDENTAL, CONSEQUENTIAL OR EXEMPLARY DAMAGES IN CONNECTION WITH OR ARISING OUT OF TI RESOURCES OR USE THEREOF, AND REGARDLESS OF WHETHER TI HAS BEEN ADVISED OF THE POSSIBILITY OF SUCH DAMAGES.

Unless TI has explicitly designated an individual product as meeting the requirements of a particular industry standard (e.g., ISO/TS 16949 and ISO 26262), TI is not responsible for any failure to meet such industry standard requirements.

Where TI specifically promotes products as facilitating functional safety or as compliant with industry functional safety standards, such products are intended to help enable customers to design and create their own applications that meet applicable functional safety standards and requirements. Using products in an application does not by itself establish any safety features in the application. Designers must ensure compliance with safety-related requirements and standards applicable to their applications. Designer may not use any TI products in life-critical medical equipment unless authorized officers of the parties have executed a special contract specifically governing such use. Life-critical medical equipment is medical equipment where failure of such equipment would cause serious bodily injury or death (e.g., life support, pacemakers, defibrillators, heart pumps, neurostimulators, and implantables). Such equipment includes, without limitation, all medical devices identified by the U.S. Food and Drug Administration as Class III devices and equivalent classifications outside the U.S.

TI may expressly designate certain products as completing a particular qualification (e.g., Q100, Military Grade, or Enhanced Product). Designers agree that it has the necessary expertise to select the product with the appropriate qualification designation for their applications and that proper product selection is at Designers' own risk. Designers are solely responsible for compliance with all legal and regulatory requirements in connection with such selection.

Designer will fully indemnify TI and its representatives against any damages, costs, losses, and/or liabilities arising out of Designer's non-compliance with the terms and provisions of this Notice.

## Looking for pricing, stock, or lifecycle information?

Click below to explore more details on WIN SOURCE:

 [View CD74HC244M](#) on WIN SOURCE

 [Texas Instruments](#) Information

## Optimize Your Supply Chain with WIN SOURCE Solutions

-  Global Sourcing Solution
-  Obsolete Management
-  Cost Control Management
-  Shortage Management
-  Alternative Solution
-  Excess Inventory Management