



**THE DATASHEET OF
EV3373-M-00A**





The Future of Analog IC Technology®

EV3373-M-00A

8 Strings, Step Up WLED Controller with External Transistor

DESCRIPTION

The MP3373 is a step-up controller with 8-channel external current sources designed for driving the WLED arrays for large size LCD panel backlighting applications.

The MP3373 employs peak current mode, fixed frequency architecture to provide robust operation with 9V to 40V input supply. The switching frequency is programmable by an external frequency setting resistor.

The MP3373 integrates the constant current control circuit to regulate each LED string current to the programmed value set by an external resistor. And the current matching can achieve 1.2% regulation accuracy between strings. Its low 200mV regulation voltage on LED current sources reduces power loss and improves efficiency.

To reduce inrush current and the stress of components, MP3373 employs the phase shift PWM dimming mode which can be disabled by pulling PSEN pin to GND.

MP3373 also includes UVLO, LED short/open protection, inductor/diode short protection and thermal shut down protection. All fault status is indicated by fault flag signal.

The MP3373 is flexible for extending LED channels with two or three ICs in parallel with sharing one power stage. It is available in TSSOP28 and SOIC28 packages.

ELECTRICAL SPECIFICATIONS

Parameter	Symbol	Value	Units
Input Voltage	V_{IN}	9 – 28	V
LEDs #		8 LED string 10 LEDs/string	
LED Current	I_{LED}	200/string	mA

FEATURES

- 9V to 40V Input Voltage Range
- 8-Channel LED strings with external current balance
- 1.2% Current Matching Accuracy Between Strings
- Programmable Switching Frequency
- External PWM Dimming
- Selectable Phase Shift Function at PWM DIM Mode
- Open/Short LED Protection
- Short Inductor/Diode Protection
- Programmable Over-voltage Protection
- Thermal Shutdown
- Fault Flag Output
- Extendable LED Channels with Share One Set of Power Stage
- TSSOP-28 and SOIC-28 Packages

APPLICATIONS

- LCD Flat Panel Displays
- 2D/3D LCD TVs and Monitors

All MPS parts are lead-free and adhere to the RoHS directive. For MPS green status, please visit MPS website under Products, Quality Assurance page.

"MPS" and "The Future of Analog IC Technology" are registered trademarks of Monolithic Power Systems, Inc.

EV3373-M-00A EVALUATION BOARD

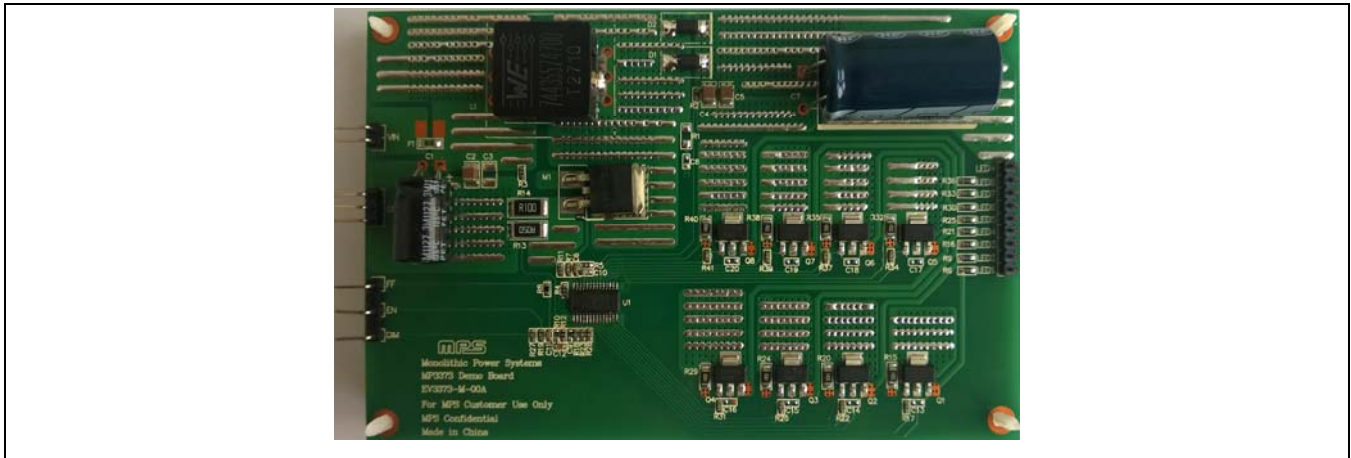

(L x W x H) 13.1cm x 8.7cm x 1.6cm

Board Number	MPS IC Number
EV3373-M-00A	MP3373

EVALUATION BOARD SCHEMATIC

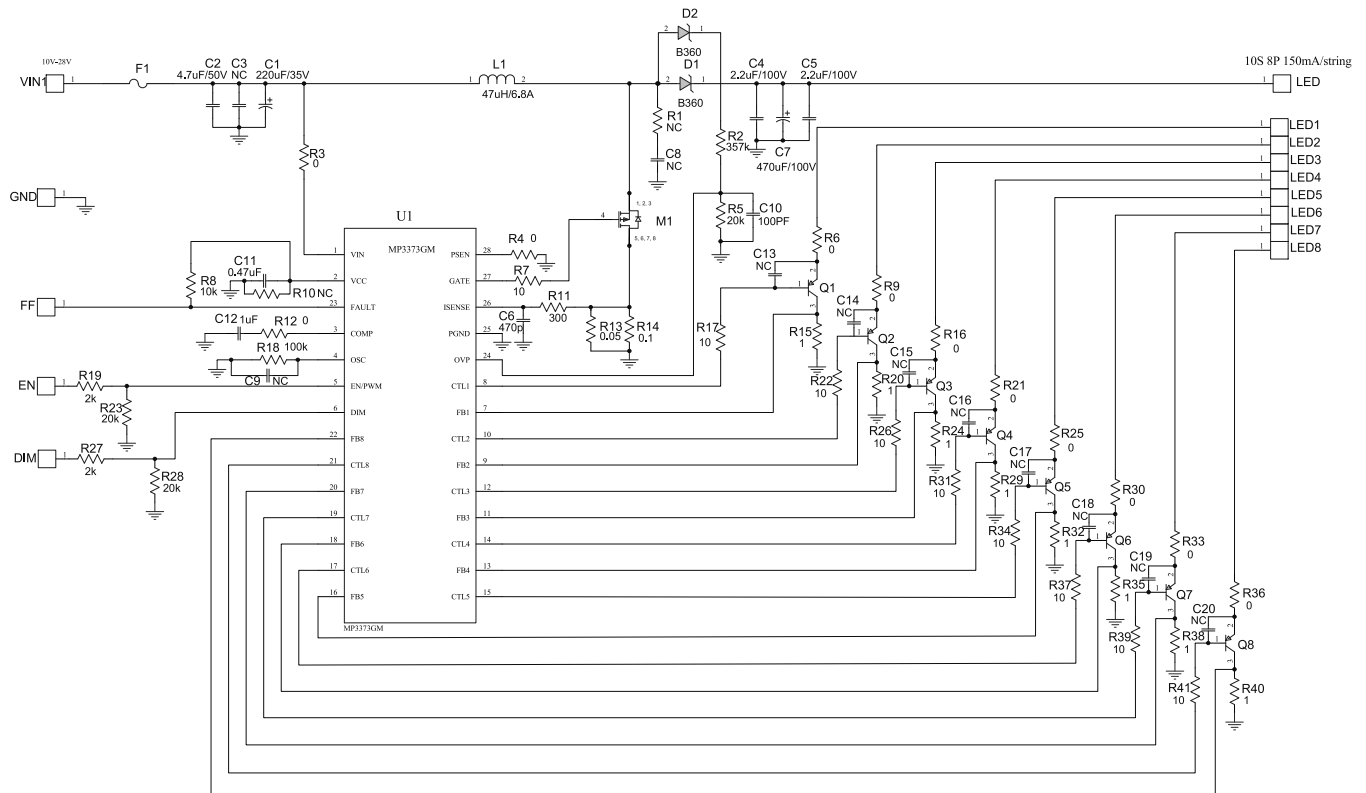

EV3373A-S-00A BILL OF MATERIALS

Qty	Ref	Value	Description	Package	Manufacturer	Part Number
1	C1	220uF	Electrolytic Capacitor, 50V	DIP	Rubycon	50YXF220MEFC
1	C2	4.7µF	Ceramic Capacitor, 50V, X7R	1210	Murata	GRM32ER71H475KA88L
1	C3	NC		1210		
2	C4,C5	2.2µF	Ceramic Capacitor, 100V, X7R	1210	Murata	GRM32ER72A225KA35L
1	C7	470uF	Electrolytic Capacitor, 100V	DIP	江海	CD263-100V470
10	C8,C9, C13~ C20	NC		0603		
1	C10	100pF	Ceramic Capacitor, 50V, COG	0603	Murata	GRM1885C1H101JA01
1	C11	0.47uF	Ceramic Capacitor, 25V, X7R	0603	Murata	GRM188R71EH474LKA12
1	C12	1uF	Ceramic Capacitor, 25V, X7R	0603	Murata	GRM188R71E105KA12
1	C6	470pF	Ceramic Capacitor, 50V, COG	0603	Murata	GRM1885C1H471JA01
2	D1,D2		Diode Schottky, 60V, 3A	SMA	Diodes Inc	B360A
1	F1	0Ω	Fuse, 4A, 63V	1206	Cooper Bussman	CC12H4A
1	L1	47µH	Inductor,6.8A	SMD	Würth	74435574700
1	M1		N- channel MOSFET	TO-263	Analog Power	AM90N10-07B
8	Q1-Q8		PNP, Transistor,-100V,-5A	SOT223	Zetex	FZT953TA
1	R2	357kΩ	Resistor, 1%	0603	Yageo	RC0603FR-07357KL
2	R1,R10	NC		0603		
11	R3,R4,R6,R9,R12,R16,R21,R25,R30,R33,R36	0Ω	Resistor, 1%	0603	Yageo	RC0603JR-070RL
1	R8	10kΩ	Resistor, 1%	0603	Yageo	RC0603FR-0710KL
1	R11	300Ω	Resistor, 1%	0603	Yageo	RC0603FR-07300RL
1	R13	0.05Ω	Current Resistor, 1%	2512	CYNTEC	RL3264-6-R050-FN
1	R14	0.1Ω	Current Resistor, 1%	2512	CYNTEC	RL3264-6-R100-FN
8	R15,R20,R24,R29,R32,R35,R38,R40	1Ω	Resistor, 1%	1206	Yageo	RC1206FR-071RL

EV3373A-S-00A BILL OF MATERIALS

Qty	Ref	Value	Description	Package	Manufacturer	Part Number
9	R7,R17,R22,R26,R31,R34,R37,R39,R41	10 Ω	Resistor, 1%	0603	Yageo	RC0603FR-0710RL
1	R18	100k Ω	Resistor, 1%	0603	Yageo	RC0603FR-07100KL
2	R19,R27	2k Ω	Resistor, 1%	0603	Yageo	RC0603FR-072KL
3	R5,R23,R28	20k Ω	Resistor, 1%	0603	Yageo	RC0603FR-0720KL
1	U1		LED Driver IC	TSSOP28	MPS	MP3373GM

EVB TEST RESULTS

Performance waveforms are tested on the evaluation board.

$V_{IN} = 18V$, 10 LEDs in series, 8 strings parallel, 200mA/string, $T_A = 25^{\circ}C$, unless otherwise noted.

Steady State

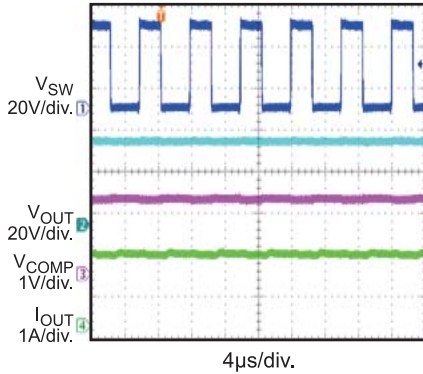

EN Power On

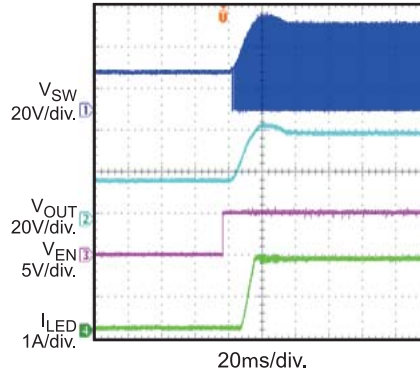

DC Dimming

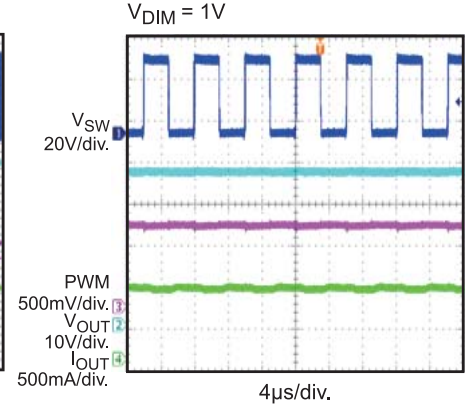

EN Dimming

200Hz 50% PWM Dimming

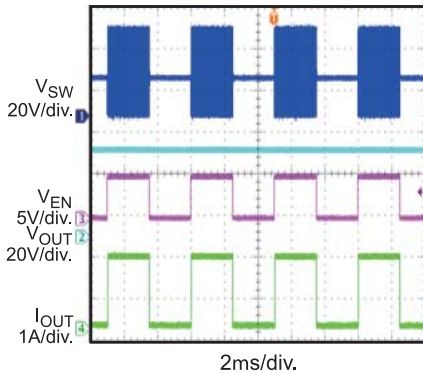

PWM Dimming

200Hz 50% PWM Dimming

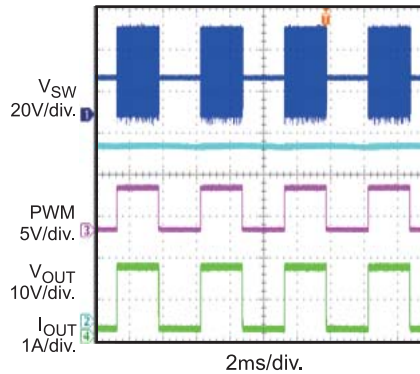

Phase Shift

200Hz 10% PWM Dimming

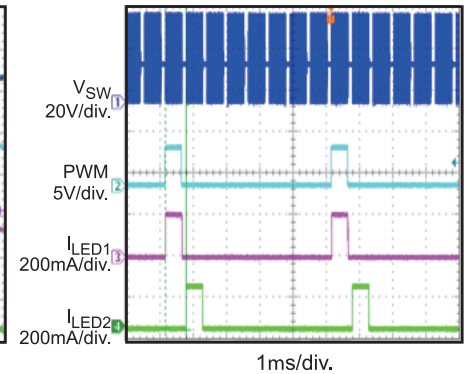

Open a String@ working normally

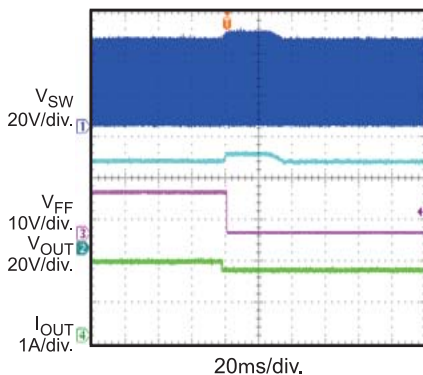

Short a String@ working normally

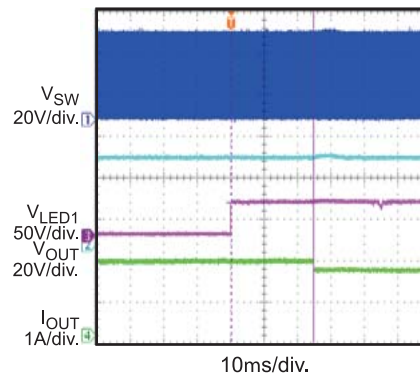

Short Inductor

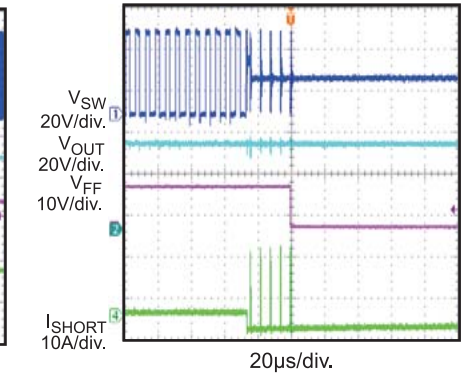

PRINTED CIRCUIT BOARD LAYOUT

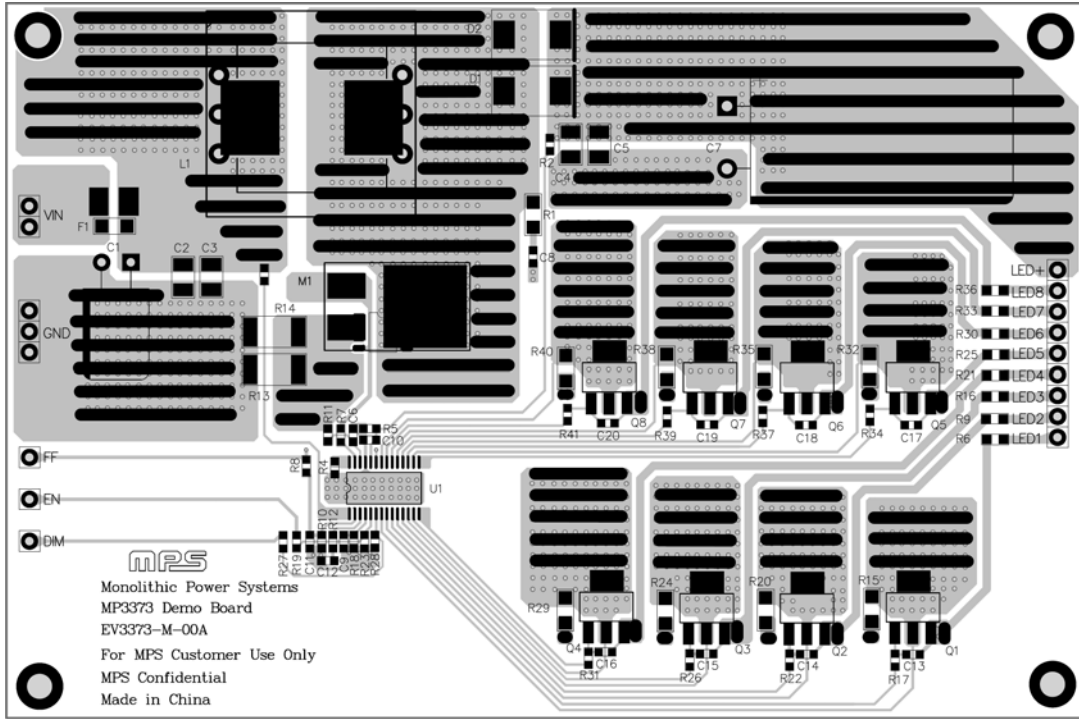

Figure 1—Top Layer

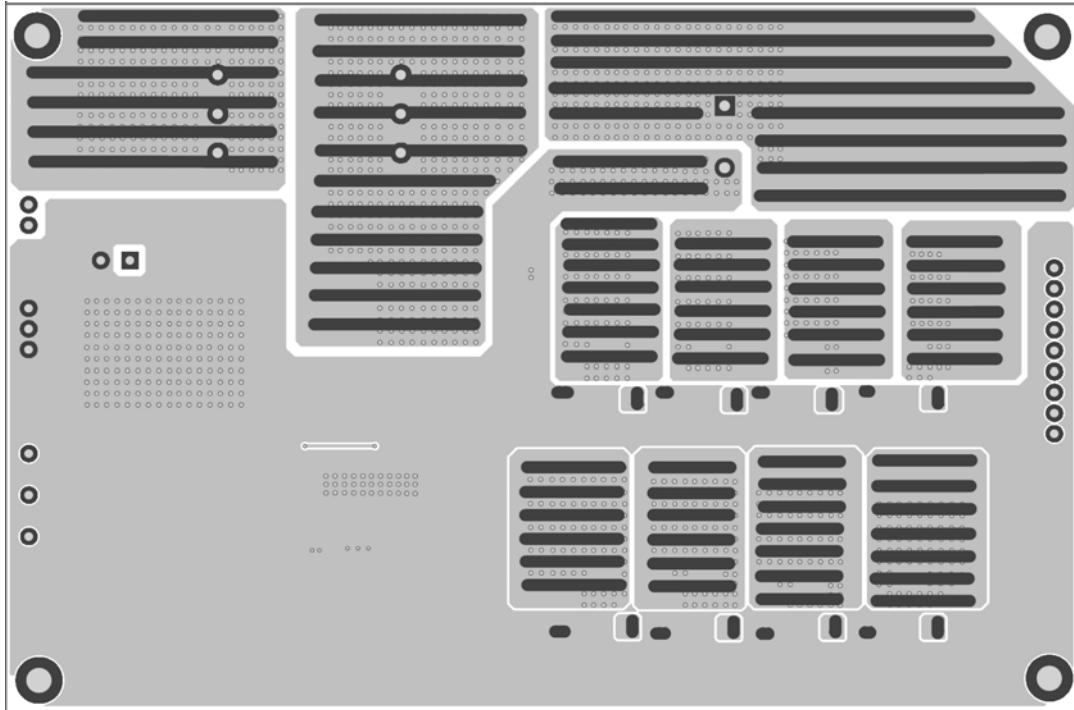

Figure 2—Bottom Layer



QUICK START GUIDE

1. Connect the positive and negative terminals of the load panel (10 white LEDs in series, 8 strings) to the LED+ and LED-1~8 pins (external PNP's Emitter) on the EV board, respectively.
2. Connect the positive and negative terminals of the power supply (9V ~ 28V) to the VIN and GND pins on the EV board, respectively.
3. Drive EN pin high (5V) to enable the MP3373.
4. For PWM dimming, apply a PWM rectangular waveform with a minimum voltage less than 0.3V and a maximum greater than 1.6V on EN/PWM pin or DIM pin (if using EN/PWM pin, need pull DIM pin to high level). The frequency of the PWM signal is recommended between 200Hz to 2kHz.
5. For analog dimming, apply a DC waveform with a voltage between 0.4 and 1.5V on DIM pin.

NOTICE: The information in this document is subject to change without notice. Users should warrant and guarantee that third party Intellectual Property rights are not infringed upon when integrating MPS products into any application. MPS will not assume any legal responsibility for any said applications.

Looking for pricing, stock, or lifecycle information?

Click below to explore more details on WIN SOURCE:

-  [View EV3373-M-00A on WIN SOURCE](#)
-  [Monolithic Power Systems Inc. Information](#)

Optimize Your Supply Chain with WIN SOURCE Solutions

-  Global Sourcing Solution
-  Obsolete Management
-  Cost Control Management
-  Shortage Management
-  Alternative Solution
-  Excess Inventory Management