



**THE DATASHEET OF  
MRF21085LSR3**



# RF Power Field Effect Transistors

## N-Channel Enhancement-Mode Lateral MOSFETs

Designed for W-CDMA base station applications with frequencies from 2110 to 2170 MHz. Suitable for TDMA, CDMA and multicarrier amplifier applications. To be used in Class AB for PCN-PCS/cellular radio and WLL applications.

- Typical 2-Carrier W-CDMA Performance:  $V_{DD} = 28$  Volts,  $I_{DQ} = 1000$  mA,  $P_{out} = 19$  Watts Avg., Full Frequency Band, Channel Bandwidth = 3.84 MHz, Peak/Avg. = 8.5 dB @ 0.01% Probability on CCDF.  
Power Gain — 13.6 dB  
Drain Efficiency — 23%  
IM3 @ 10 MHz Offset — -37.5 dBc in 3.84 MHz Channel Bandwidth  
ACPR @ 5 MHz Offset — -41 dBc in 3.84 MHz Channel Bandwidth
- Capable of Handling 5:1 VSWR, @ 28 Vdc, 2140 MHz, 90 Watts CW Output Power

### Features

- Internally Matched for Ease of Use
- High Gain, High Efficiency and High Linearity
- Integrated ESD Protection
- Designed for Maximum Gain and Insertion Phase Flatness
- Excellent Thermal Stability
- Characterized with Series Equivalent Large-Signal Impedance Parameters
- Available with Low Gold Plating Thickness on Leads. L Suffix Indicates 40 $\mu$ " Nominal.
- RoHS Compliant
- In Tape and Reel. R3 Suffix = 250 Units per 56 mm, 13 inch Reel.

**MRF21085LR3**  
**MRF21085LSR3**

**2110-2170 MHz, 90 W, 28 V**  
**LATERAL N-CHANNEL**  
**RF POWER MOSFETs**

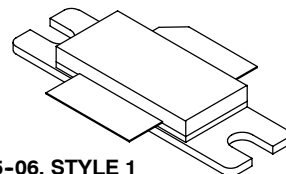

**CASE 465-06, STYLE 1**  
**NI-780**  
**MRF21085LR3**

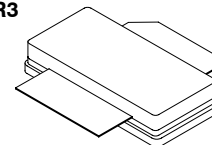

**CASE 465A-06, STYLE 1**  
**NI-780S**  
**MRF21085LSR3**

**Table 1. Maximum Ratings**

Rating	Symbol	Value	Unit
Drain-Source Voltage	$V_{DSS}$	-0.5, +65	Vdc
Gate-Source Voltage	$V_{GS}$	-0.5, +15	Vdc
Total Device Dissipation @ $T_C = 25^\circ\text{C}$ Derate above 25 $^\circ\text{C}$	$P_D$	224 1.28	W W/ $^\circ\text{C}$
Storage Temperature Range	$T_{stg}$	-65 to +150	$^\circ\text{C}$
Case Operating Temperature	$T_C$	150	$^\circ\text{C}$
Operating Junction Temperature	$T_J$	200	$^\circ\text{C}$

**Table 2. Thermal Characteristics**

Characteristic	Symbol	Value	Unit
Thermal Resistance, Junction to Case	$R_{\theta JC}$	0.78	$^\circ\text{C}/\text{W}$

**Table 3. ESD Protection Characteristics**

Test Conditions	Class
Human Body Model	1 (Minimum)
Machine Model	M3 (Minimum)

**Table 4. Electrical Characteristics** ( $T_C = 25^\circ\text{C}$  unless otherwise noted)

Characteristic	Symbol	Min	Typ	Max	Unit
<b>Off Characteristics</b>					
Drain-Source Breakdown Voltage ( $V_{GS} = 0\text{ Vdc}$ , $I_D = 100\ \mu\text{Adc}$ )	$V_{(BR)DSS}$	65	—	—	Vdc
Zero Gate Voltage Drain Current ( $V_{DS} = 28\text{ Vdc}$ , $V_{GS} = 0\text{ Vdc}$ )	$I_{DSS}$	—	—	10	$\mu\text{Adc}$
Gate-Source Leakage Current ( $V_{GS} = 5\text{ Vdc}$ , $V_{DS} = 0\text{ Vdc}$ )	$I_{GSS}$	—	—	1	$\mu\text{Adc}$
<b>On Characteristics (DC)</b>					
Gate Threshold Voltage ( $V_{DS} = 10\text{ Vdc}$ , $I_D = 200\ \mu\text{Adc}$ )	$V_{GS(th)}$	2	—	4	Vdc
Gate Quiescent Voltage ( $V_{DS} = 28\text{ Vdc}$ , $I_D = 1000\text{ mAdc}$ )	$V_{GS(Q)}$	3	3.9	5	Vdc
Drain-Source On-Voltage ( $V_{GS} = 10\text{ Vdc}$ , $I_D = 2\text{ Adc}$ )	$V_{DS(on)}$	—	0.18	0.21	Vdc
<b>Dynamic Characteristics (1)</b>					
Reverse Transfer Capacitance ( $V_{DS} = 28\text{ Vdc}$ , $V_{GS} = 0$ , $f = 1.0\text{ MHz}$ )	$C_{rss}$	—	3.6	—	pF
<b>Functional Tests</b> (In Freescale Test Fixture, 50 ohm system) 2-carrier W-CDMA, 3.84 MHz Channel Bandwidth Carriers, ACPR and IM3 measured in 3.84 MHz Bandwidth. Peak/Avg. = 8.3 dB @ 0.01% Probability on CCDF.					
Common-Source Amplifier Power Gain ( $V_{DD} = 28\text{ Vdc}$ , $P_{out} = 19\text{ W Avg.}$ , $I_{DQ} = 1000\text{ mA}$ , $f_1 = 2112.5\text{ MHz}$ , $f_2 = 2122.5\text{ MHz}$ and $f_1 = 2157.5\text{ MHz}$ , $f_2 = 2167.5\text{ MHz}$ )	$G_{ps}$	12	13.6	—	dB
Drain Efficiency ( $V_{DD} = 28\text{ Vdc}$ , $P_{out} = 19\text{ W Avg.}$ , $I_{DQ} = 1000\text{ mA}$ , $f_1 = 2112.5\text{ MHz}$ , $f_2 = 2122.5\text{ MHz}$ and $f_1 = 2157.5\text{ MHz}$ , $f_2 = 2167.5\text{ MHz}$ )	$\eta$	20	23	—	%
Third Order Intermodulation Distortion ( $V_{DD} = 28\text{ Vdc}$ , $P_{out} = 19\text{ W Avg.}$ , $I_{DQ} = 1000\text{ mA}$ , $f_1 = 2112.5\text{ MHz}$ , $f_2 = 2122.5\text{ MHz}$ and $f_1 = 2157.5\text{ MHz}$ , $f_2 = 2167.5\text{ MHz}$ ; IM3 measured over 3.84 MHz BW at $f_1 - 10\text{ MHz}$ and $f_2 + 10\text{ MHz}$ referenced to carrier channel power.)	IM3	—	-37.5	-35	dBc
Adjacent Channel Power Ratio ( $V_{DD} = 28\text{ Vdc}$ , $P_{out} = 19\text{ W Avg.}$ , $I_{DQ} = 1000\text{ mA}$ , $f_1 = 2112.5\text{ MHz}$ , $f_2 = 2122.5\text{ MHz}$ and $f_1 = 2157.5\text{ MHz}$ , $f_2 = 2167.5\text{ MHz}$ ; ACPR measured over 3.84 MHz at $f_1 - 5\text{ MHz}$ and $f_2 + 5\text{ MHz}$ .)	ACPR	—	-41	-38	dBc
Input Return Loss ( $V_{DD} = 28\text{ Vdc}$ , $P_{out} = 19\text{ W Avg.}$ , $I_{DQ} = 1000\text{ mA}$ , $f_1 = 2112.5\text{ MHz}$ , $f_2 = 2122.5\text{ MHz}$ and $f_1 = 2157.5\text{ MHz}$ , $f_2 = 2167.5\text{ MHz}$ )	IRL	—	-12	-9	dB

1. Part is internally matched both on input and output.

(continued)

**Table 4. Electrical Characteristics** ( $T_C = 25^\circ\text{C}$  unless otherwise noted) **(continued)**

Characteristic	Symbol	Min	Typ	Max	Unit
<b>Functional Tests</b> (In Freescale Test Fixture, 50 ohm system) <b>(continued)</b>					
Two-Tone Common-Source Amplifier Power Gain ( $V_{DD} = 28\text{ Vdc}$ , $P_{out} = 90\text{ W PEP}$ , $I_{DQ} = 1000\text{ mA}$ , $f_1 = 2110\text{ MHz}$ , $f_2 = 2120\text{ MHz}$ and $f_1 = 2160\text{ MHz}$ , $f_2 = 2170\text{ MHz}$ )	$G_{ps}$	—	13.6	—	dB
Two-Tone Drain Efficiency ( $V_{DD} = 28\text{ Vdc}$ , $P_{out} = 90\text{ W PEP}$ , $I_{DQ} = 1000\text{ mA}$ , $f_1 = 2110\text{ MHz}$ , $f_2 = 2120\text{ MHz}$ and $f_1 = 2160\text{ MHz}$ , $f_2 = 2170\text{ MHz}$ )	$\eta$	—	36	—	%
Two-Tone Intermodulation Distortion ( $V_{DD} = 28\text{ Vdc}$ , $P_{out} = 90\text{ W PEP}$ , $I_{DQ} = 1000\text{ mA}$ , $f_1 = 2110\text{ MHz}$ , $f_2 = 2120\text{ MHz}$ and $f_1 = 2160\text{ MHz}$ , $f_2 = 2170\text{ MHz}$ )	IMD	—	-31	—	dBc
Input Return Loss ( $V_{DD} = 28\text{ Vdc}$ , $P_{out} = 90\text{ W PEP}$ , $I_{DQ} = 1000\text{ mA}$ , $f_1 = 2110\text{ MHz}$ , $f_2 = 2120\text{ MHz}$ and $f_1 = 2160\text{ MHz}$ , $f_2 = 2170\text{ MHz}$ )	IRL	—	-12	—	dB
$P_{out}$ , 1 dB Compression Point ( $V_{DD} = 28\text{ Vdc}$ , $I_{DQ} = 1000\text{ mA}$ , $f = 2170\text{ MHz}$ )	P1dB	—	100	—	W

ARCHIVE INFORMATION

ARCHIVE INFORMATION

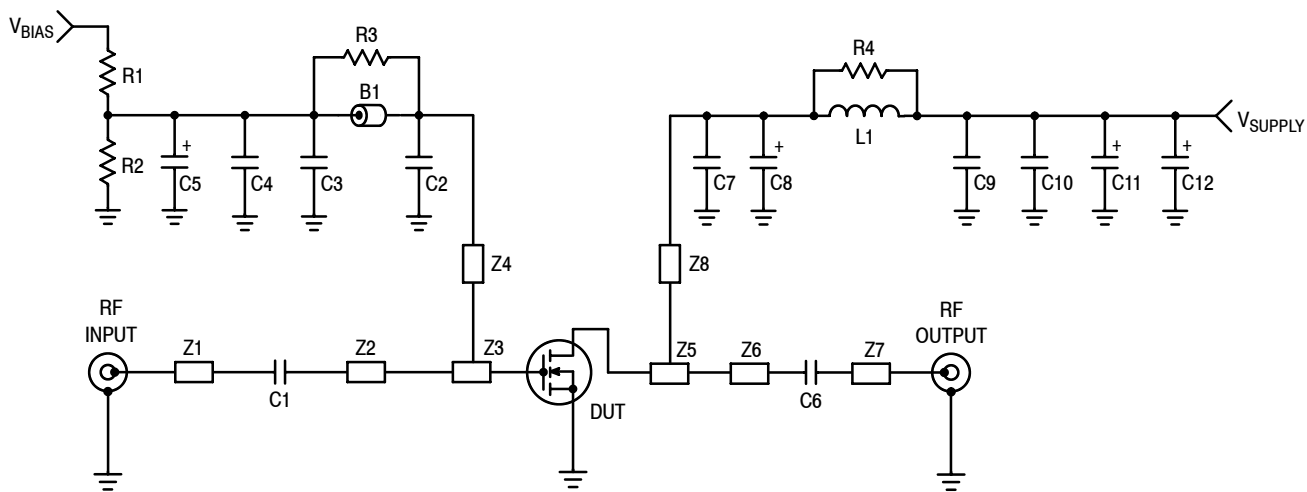

- Z1        0.750" x 0.084" Microstrip
- Z2        1.015" x 0.084" Microstrip
- Z3        0.480" x 0.800" Microstrip
- Z4        0.750" x 0.050" Microstrip
- Z5        0.610" x 0.800" Microstrip
- Z6        0.885" x 0.084" Microstrip
- Z7        0.720" x 0.084" Microstrip
- Z8        0.800" x 0.070" Microstrip

Board        0.030" Glass Teflon®,  
Keene GX-0300-55-22,  $\epsilon_r = 2.55$

PCB         Etched Circuit Boards  
MRF21085 Rev. 3, CMR

**Figure 1. MRF21085L Test Circuit Schematic**

**Table 5. MRF21085 Test Circuit Component Designations and Values**

Designators	Description
B1	Short Ferrite Bead, Fair Rite, #2743019447
C1, C6	43 pF Chip Capacitors, ATC #100B430JCA500X
C2	10 pF Chip Capacitor, ATC #100B100JCA500X
C3, C9	1000 pF Chip Capacitors, ATC #100B102JCA500X
C4, C10	0.1 $\mu$ F Chip Capacitors, Kemet #CDR33BX104AKWS
C5	1.0 $\mu$ F Tantalum Chip Capacitor, Kemet #T491C105M050
C7	2.7 pF Chip Capacitor, ATC #100B2R7JCA500X
C8	10 $\mu$ F Tantalum Chip Capacitor, Kemet #T495X106K035AS4394
C11, C12	22 $\mu$ F Tantalum Chip Capacitors, Kemet #T491X226K035AS4394
L1	1 Turn, #20 AWG, 0.100" ID
N1, N2	Type N Flange Mounts, Omni Spectra #3052-1648-10
R1	1.0 k $\Omega$ , 1/8 W Chip Resistor
R2	180 k $\Omega$ , 1/8 W Chip Resistor
R3, R4	10 $\Omega$ , 1/8 W Chip Resistors

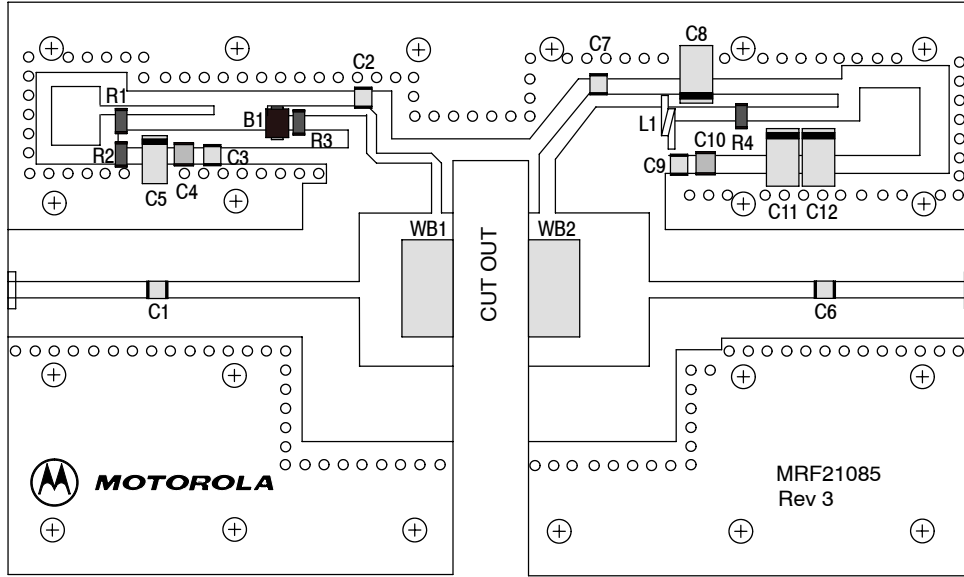

Freescale has begun the transition of marking Printed Circuit Boards (PCBs) with the Freescale Semiconductor signature/logo. PCBs may have either Motorola or Freescale markings during the transition period. These changes will have no impact on form, fit or function of the current product.

**Figure 2. MRF21085L Test Circuit Component Layout**

### TYPICAL CHARACTERISTICS

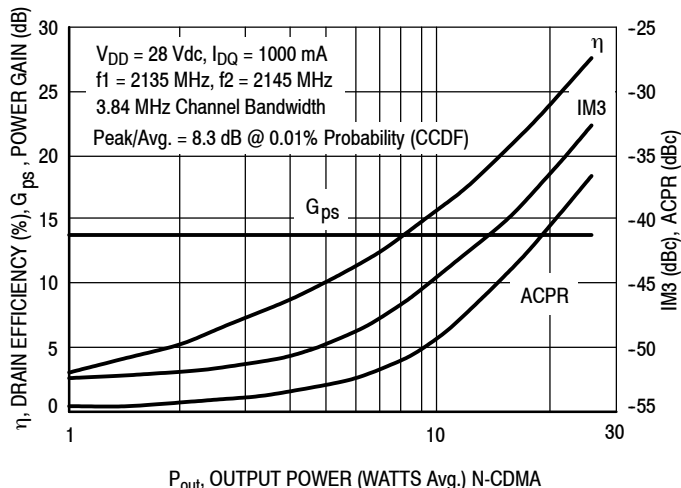

**Figure 3. 2-Carrier W-CDMA ACPR, IM3, Power Gain and Drain Efficiency versus Output Power**

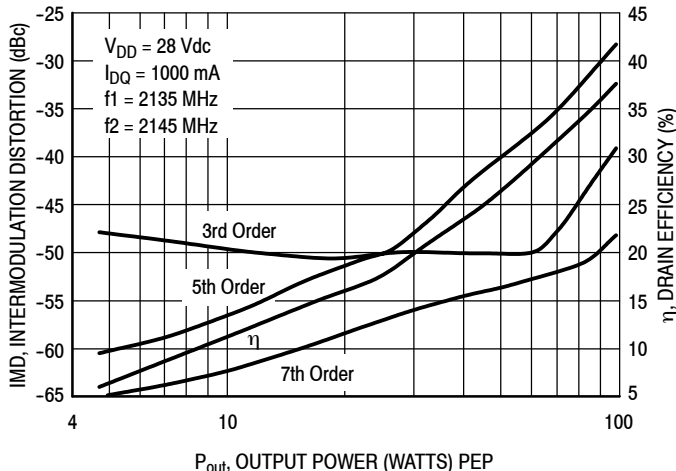

**Figure 4. Intermodulation Distortion Products versus Output Power**

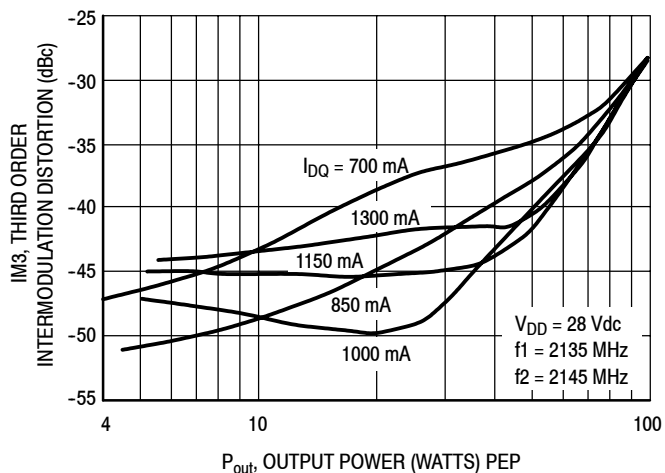

**Figure 5. Third Order Intermodulation Distortion versus Output Power**

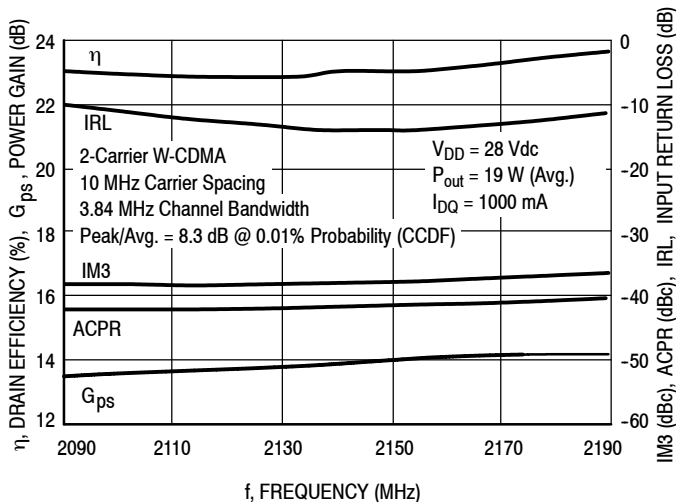

**Figure 6. 2-Carrier W-CDMA Broadband Performance**

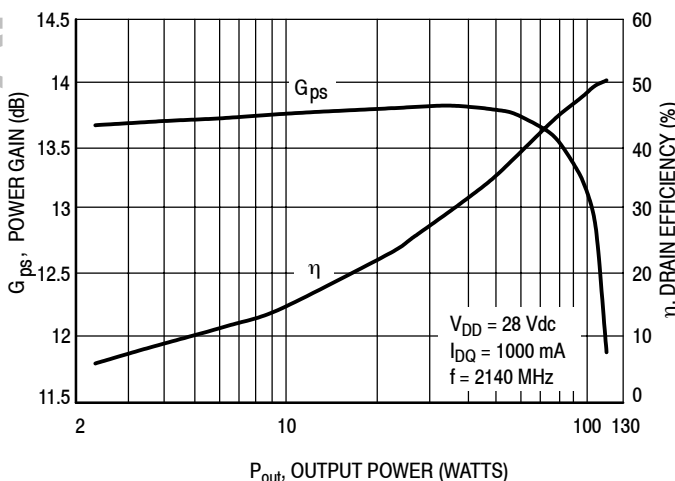

**Figure 7. CW Performance**

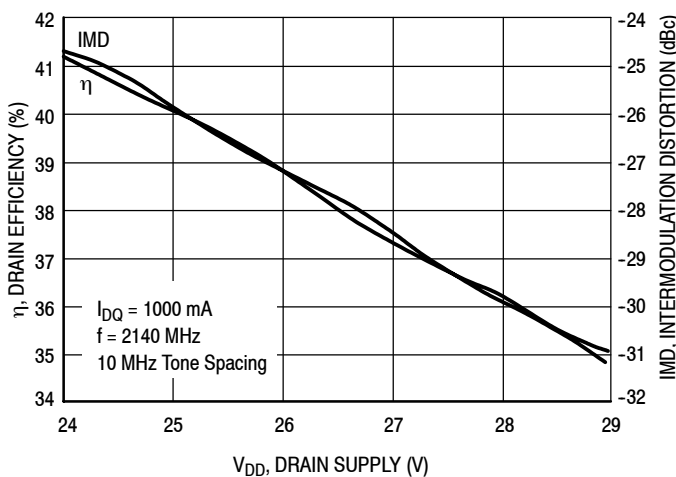
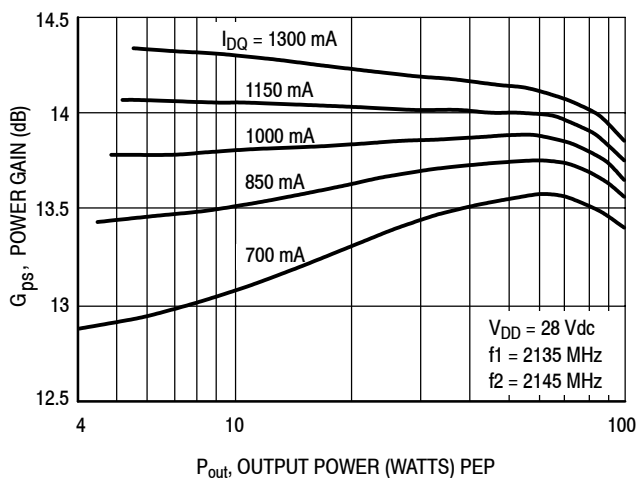

**Figure 8. Two-Tone Intermodulation Distortion and Drain Efficiency versus Drain Supply**

ARCHIVE INFORMATION

ARCHIVE INFORMATION

### TYPICAL CHARACTERISTICS



**Figure 9. Two-Tone Power Gain versus Output Power**

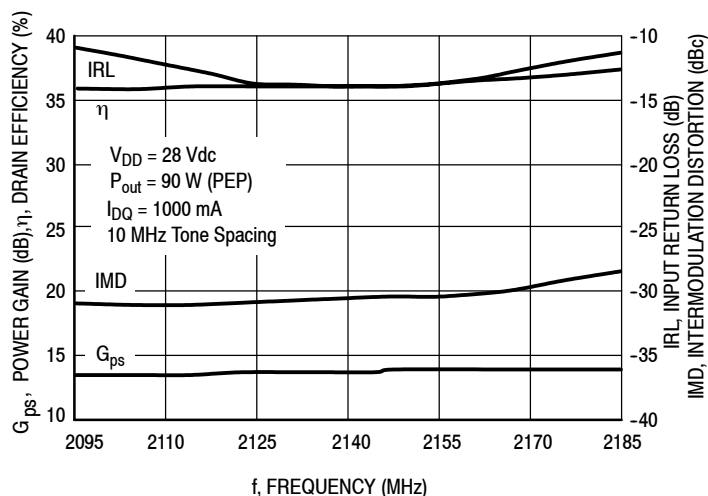

**Figure 10. Two-Tone Broadband Performance**

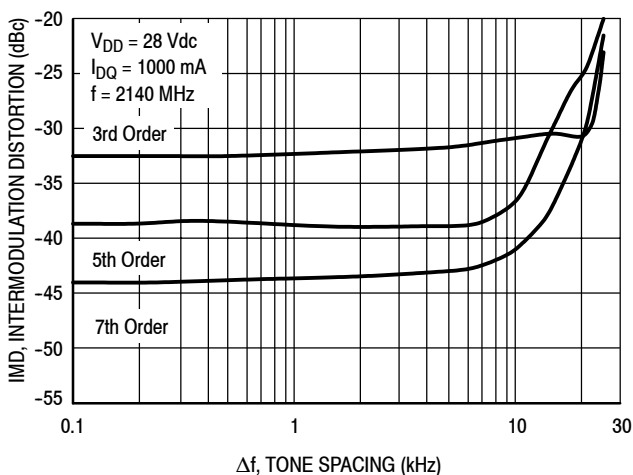

**Figure 11. Intermodulation Distortion Products versus Two-Tone Spacing**

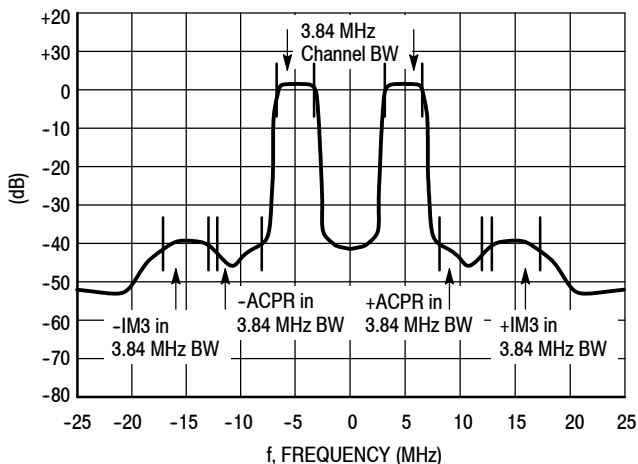

**Figure 12. 2-Carrier W-CDMA Spectrum**

ARCHIVE INFORMATION

ARCHIVE INFORMATION

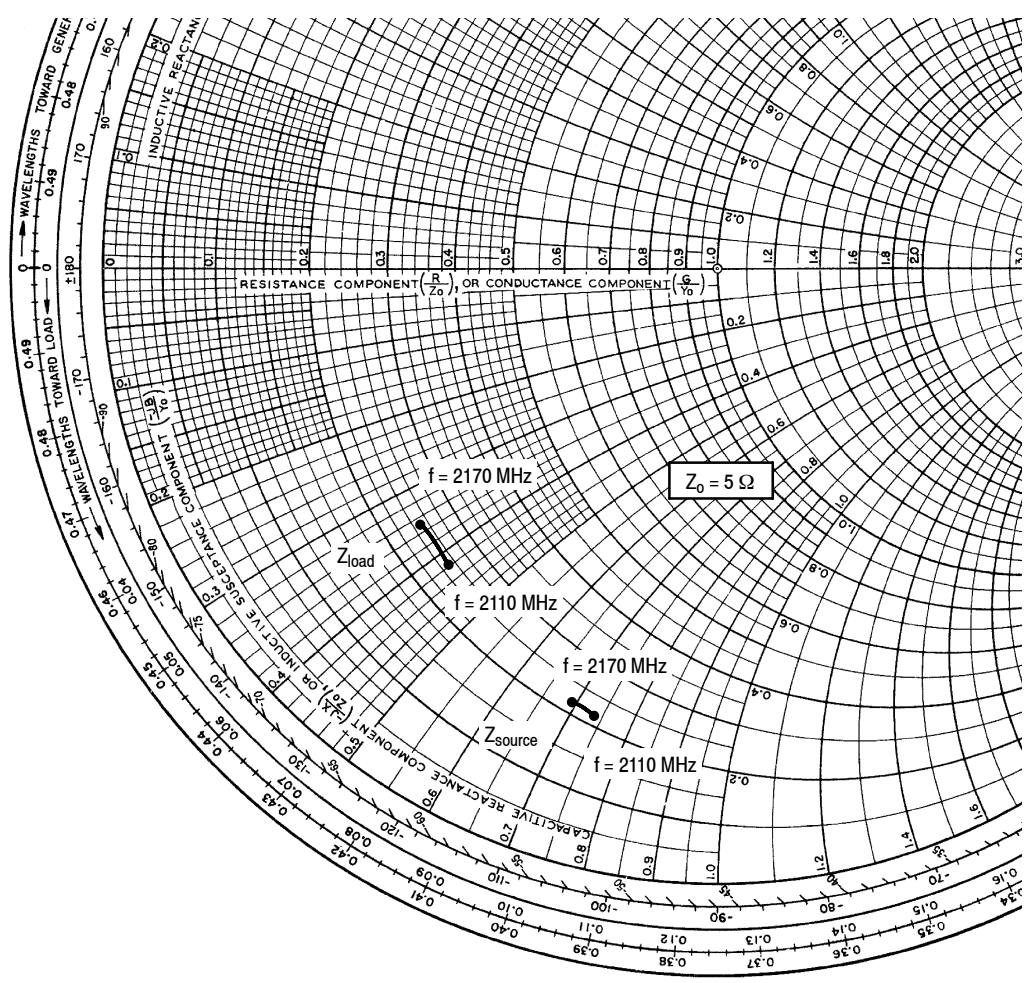

$V_{DD} = 28\text{ V}$ ,  $I_{DQ} = 1000\text{ mA}$ ,  $P_{out} = 19\text{ W Avg.}$

f MHz	$Z_{source}$ $\Omega$	$Z_{load}$ $\Omega$
2110	$1.10 - j3.71$	$1.23 - j2.10$
2140	$1.11 - j3.57$	$1.26 - j1.92$
2170	$1.12 - j3.40$	$1.25 - j1.76$

$Z_{source}$  = Test circuit impedance as measured from gate to ground.

$Z_{load}$  = Test circuit impedance as measured from drain to ground.

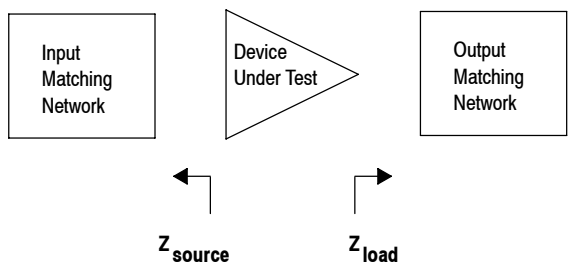

Figure 13. Series Equivalent Source and Load Impedance

ARCHIVE INFORMATION

ARCHIVE INFORMATION

ARCHIVE INFORMATION

ARCHIVE INFORMATION

### PACKAGE DIMENSIONS

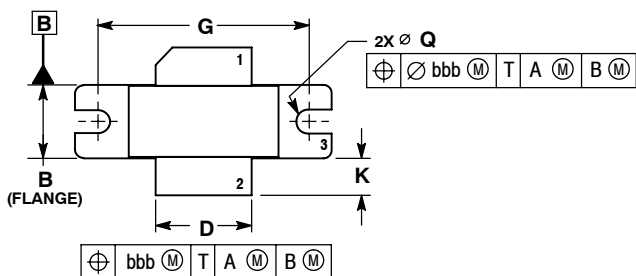

- NOTES:
1. DIMENSIONING AND TOLERANCING PER ANSI Y14.5M-1994.
  2. CONTROLLING DIMENSION: INCH.
  3. DELETED
  4. DIMENSION H IS MEASURED 0.030 (0.762) AWAY FROM PACKAGE BODY.

DIM	INCHES		MILLIMETERS	
	MIN	MAX	MIN	MAX
A	1.335	1.345	33.91	34.16
B	0.380	0.390	9.65	9.91
C	0.125	0.170	3.18	4.32
D	0.495	0.505	12.57	12.83
E	0.035	0.045	0.89	1.14
F	0.003	0.006	0.08	0.15
G	1.100 BSC		27.94 BSC	
H	0.057	0.067	1.45	1.70
K	0.170	0.210	4.32	5.33
M	0.774	0.786	19.66	19.96
N	0.772	0.788	19.60	20.00
Q	Ø.118	Ø.138	Ø3.00	Ø3.51
R	0.365	0.375	9.27	9.53
S	0.365	0.375	9.27	9.52
aaa	0.005 REF		0.127 REF	
bbb	0.010 REF		0.254 REF	
ccc	0.015 REF		0.381 REF	

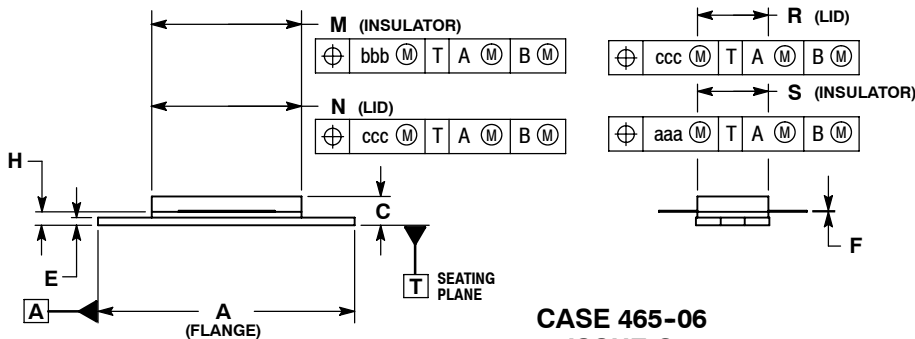

- STYLE 1:
1. DRAIN
  2. GATE
  3. SOURCE

**CASE 465-06  
ISSUE G  
NI-780  
MRF21085LR3**

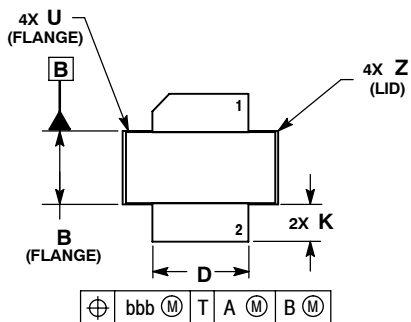

- NOTES:
1. DIMENSIONING AND TOLERANCING PER ANSI Y14.5M-1994.
  2. CONTROLLING DIMENSION: INCH.
  3. DELETED
  4. DIMENSION H IS MEASURED 0.030 (0.762) AWAY FROM PACKAGE BODY.

DIM	INCHES		MILLIMETERS	
	MIN	MAX	MIN	MAX
A	0.805	0.815	20.45	20.70
B	0.380	0.390	9.65	9.91
C	0.125	0.170	3.18	4.32
D	0.495	0.505	12.57	12.83
E	0.035	0.045	0.89	1.14
F	0.003	0.006	0.08	0.15
H	0.057	0.067	1.45	1.70
K	0.170	0.210	4.32	5.33
M	0.774	0.786	19.61	20.02
N	0.772	0.788	19.61	20.02
R	0.365	0.375	9.27	9.53
S	0.365	0.375	9.27	9.52
U	---	0.040	---	1.02
Z	---	0.030	---	0.76
aaa	0.005 REF		0.127 REF	
bbb	0.010 REF		0.254 REF	
ccc	0.015 REF		0.381 REF	

- STYLE 1:
1. DRAIN
  2. GATE
  5. SOURCE

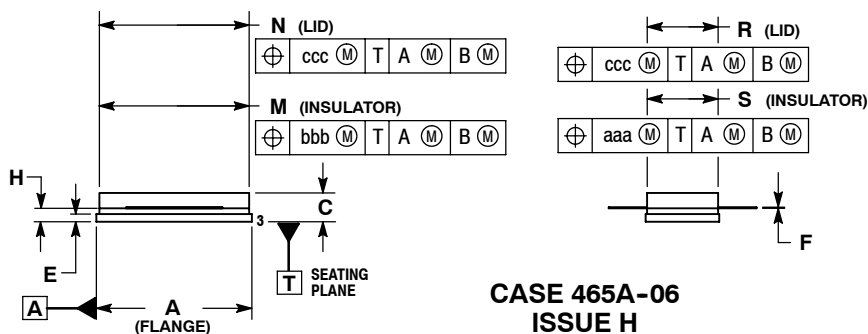

**CASE 465A-06  
ISSUE H  
NI-780S  
MRF21085LSR3**

ARCHIVE INFORMATION

ARCHIVE INFORMATION

## REVISION HISTORY

The following table summarizes revisions to this document.

Revision	Date	Description
9	Dec. 2010	<ul style="list-style-type: none"> <li>• MRF21085 Rev. 9 data sheet archived. Data sheet split due to change in part life cycle. See MRF21085-1 Rev. 10 for MRF21085LR3 and MRF21085-2 Rev. 11 for MRF21085LSR3.</li> </ul>

ARCHIVE INFORMATION

ARCHIVE INFORMATION

**How to Reach Us:**

**Home Page:**  
www.freescale.com

**E-mail:**  
support@freescale.com

**USA/Europe or Locations Not Listed:**  
Freescale Semiconductor  
Technical Information Center, CH370  
1300 N. Alma School Road  
Chandler, Arizona 85224  
+1-800-521-6274 or +1-480-768-2130  
support@freescale.com

**Europe, Middle East, and Africa:**  
Freescale Halbleiter Deutschland GmbH  
Technical Information Center  
Schatzbogen 7  
81829 Muenchen, Germany  
+44 1296 380 456 (English)  
+46 8 52200080 (English)  
+49 89 92103 559 (German)  
+33 1 69 35 48 48 (French)  
support@freescale.com

**Japan:**  
Freescale Semiconductor Japan Ltd.  
Headquarters  
ARCO Tower 15F  
1-8-1, Shimo-Meguro, Meguro-ku,  
Tokyo 153-0064  
Japan  
0120 191014 or +81 3 5437 9125  
support.japan@freescale.com

**Asia/Pacific:**  
Freescale Semiconductor Hong Kong Ltd.  
Technical Information Center  
2 Dai King Street  
Tai Po Industrial Estate  
Tai Po, N.T., Hong Kong  
+800 2666 8080  
support.asia@freescale.com

**For Literature Requests Only:**  
Freescale Semiconductor Literature Distribution Center  
P.O. Box 5405  
Denver, Colorado 80217  
1-800-441-2447 or 303-675-2140  
Fax: 303-675-2150  
LDCForFreescaleSemiconductor@hibbertgroup.com

Information in this document is provided solely to enable system and software implementers to use Freescale Semiconductor products. There are no express or implied copyright licenses granted hereunder to design or fabricate any integrated circuits or integrated circuits based on the information in this document.

Freescale Semiconductor reserves the right to make changes without further notice to any products herein. Freescale Semiconductor makes no warranty, representation or guarantee regarding the suitability of its products for any particular purpose, nor does Freescale Semiconductor assume any liability arising out of the application or use of any product or circuit, and specifically disclaims any and all liability, including without limitation consequential or incidental damages. "Typical" parameters that may be provided in Freescale Semiconductor data sheets and/or specifications can and do vary in different applications and actual performance may vary over time. All operating parameters, including "Typicals", must be validated for each customer application by customer's technical experts. Freescale Semiconductor does not convey any license under its patent rights nor the rights of others. Freescale Semiconductor products are not designed, intended, or authorized for use as components in systems intended for surgical implant into the body, or other applications intended to support or sustain life, or for any other application in which the failure of the Freescale Semiconductor product could create a situation where personal injury or death may occur. Should Buyer purchase or use Freescale Semiconductor products for any such unintended or unauthorized application, Buyer shall indemnify and hold Freescale Semiconductor and its officers, employees, subsidiaries, affiliates, and distributors harmless against all claims, costs, damages, and expenses, and reasonable attorney fees arising out of, directly or indirectly, any claim of personal injury or death associated with such unintended or unauthorized use, even if such claim alleges that Freescale Semiconductor was negligent regarding the design or manufacture of the part.

Freescale™ and the Freescale logo are trademarks of Freescale Semiconductor, Inc. All other product or service names are the property of their respective owners.  
© Freescale Semiconductor, Inc. 2006, 2010. All rights reserved.

## Looking for pricing, stock, or lifecycle information?

Click below to explore more details on WIN SOURCE:

 [View MRF21085LSR3 on WIN SOURCE](#)

 [NXP / Nexperia Information](#)

## Optimize Your Supply Chain with WIN SOURCE Solutions

-  Global Sourcing Solution
-  Obsolete Management
-  Cost Control Management
-  Shortage Management
-  Alternative Solution
-  Excess Inventory Management