



**THE DATASHEET OF
TPC33CAHM3/H**





Surface Mount PAR[®] Transient Voltage Suppressors

Bidirectional 1500 W TVS in TO-277 (SMPC) Package

eSMP[®] Series



SMPC (TO-277A)

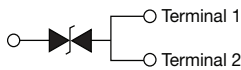

LINKS TO ADDITIONAL RESOURCES



PRIMARY CHARACTERISTICS	
V _{WM}	9.4 V to 30.8 V
V _{BR} (Bi-directional)	11 V to 36 V
P _{PPM}	1500 W
T _J max.	185 °C
Polarity	Bidirectional
Package	SMPC (TO-277A)

Note

- All electrical characteristics are only applicable when two identical polarity terminals are connected.

FEATURES

- Junction passivation optimized PAR[®] design
- T_J = 185 °C capability suitable for high reliability and automotive requirement
- Very low profile - typical height of 1.1 mm
- Ideal for automated placement
- Bidirectional
- Excellent clamping capability
- Low leakage current
- Very fast response time
- AEC-Q101 qualified
- Automotive ordering code: base P/NHM3
- Meet MSL level 1, per J-STD-020, LF maximum peak of 260 °C
- Material categorization: for definitions of compliance please see www.vishay.com/doc?99912



TYPICAL APPLICATIONS

Use in sensitive electronics protection against voltage transients induced by inductive load switching and lighting on ICs, MOSFET, signal lines of sensor units for automotive, consumer, computer, industrial, and telecommunication.

MECHANICAL DATA

Case: SMPC (TO-277A)

Molding compound meets UL 94 V-0 flammability rating Base P/NHM3 - halogen-free, RoHS-compliant, and AEC-Q101 qualified

Terminals: matte tin plated leads, solderable per J-STD-002 and JESD 22-B102

HM3 suffix meets JESD 201 class 2 whisker test

Polarity: no marking on bidirectional types

MAXIMUM RATINGS (T _A = 25 °C, unless otherwise noted)			
PARAMETER	SYMBOL	VALUE	UNIT
Peak power dissipation with a 10/1000 μs waveform ⁽¹⁾	P _{PPM}	1500	W
Peak pulse current with a 10/1000 μs waveform ⁽¹⁾	I _{PPM}	See next table	A
Operating junction and storage temperature range	T _J , T _{STG}	-65 to +185	°C

Note

⁽¹⁾ Non-repetitive current pulse per fig.3 and derated above T_A = 25 °C

**ELECTRICAL CHARACTERISTICS** ($T_A = 25\text{ }^\circ\text{C}$, unless otherwise noted)

DEVICE TYPE	DEVICE MARKING CODE	BREAKDOWN VOLTAGE V_{BR} ⁽¹⁾ AT I_T (V)		TEST CURRENT I_T (mA)	STAND-OFF VOLTAGE V_{WM} (V)	MAXIMUM REVERSE LEAKAGE AT V_{WM} I_D (μA)	MAXIMUM PEAK PULSE SURGE CURRENT I_{PPM} ⁽²⁾ (A)	MAXIMUM CLAMPING VOLTAGE AT I_{PPM} V_C (V)
		MIN.	MAX.					
TPC11CA	BAF	10.5	11.6	1.0	9.40	5.0	96.2	15.6
TPC12CA	BAG	11.4	12.6	1.0	10.2	2.0	89.8	16.7
TPC13CA	BAH	12.4	13.7	1.0	11.1	2.0	82.4	18.2
TPC15CA	BAI	14.3	15.8	1.0	12.8	1.0	70.8	21.2
TPC16CA	BAJ	15.2	16.8	1.0	13.6	1.0	66.7	22.5
TPC18CA	BAK	17.1	18.9	1.0	15.3	1.0	59.5	25.2
TPC20CA	BAL	19.0	21.0	1.0	17.1	1.0	54.2	27.7
TPC22CA	BAM	20.9	23.1	1.0	18.8	1.0	49.0	30.6
TPC24CA	BAN	22.8	25.2	1.0	20.5	1.0	45.2	33.2
TPC27CA	BAO	25.7	28.4	1.0	23.1	1.0	40.0	37.5
TPC30CA	BAP	28.5	31.5	1.0	25.6	1.0	36.2	41.4
TPC33CA	BAQ	31.4	34.7	1.0	28.2	1.0	32.8	45.7
TPC36CA	BAR	34.2	37.8	1.0	30.8	1.0	30.1	49.9

Notes

- All terms and symbols are consistent with ANSI/IEEE C62.35
- ⁽¹⁾ V_{BR} measured after I_T applied for 300 μs , I_T = square wave pulse or equivalent
- ⁽²⁾ Surge current waveform per fig.3

ORDERING INFORMATION (Example)

PREFERRED P/N	UNIT WEIGHT (g)	PREFERRED PACKAGE CODE	BASE QUANTITY	DELIVERY MODE
TPC11CAHM3/H ⁽¹⁾	0.10	H	1500	7" diameter plastic tape and reel
TPC11CAHM3/I ⁽¹⁾	0.10	I	6500	13" diameter plastic tape and reel

Note

- ⁽¹⁾ AEC-Q101 qualified



RATINGS AND CHARACTERISTICS CURVES ($T_A = 25\text{ }^\circ\text{C}$, unless otherwise noted)

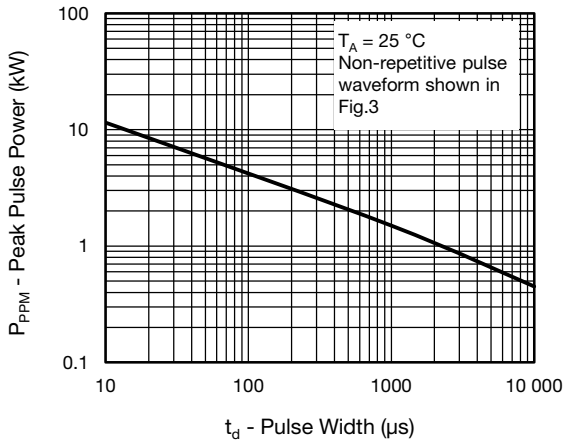

Fig. 1 - Peak Pulse Power Rating Curve

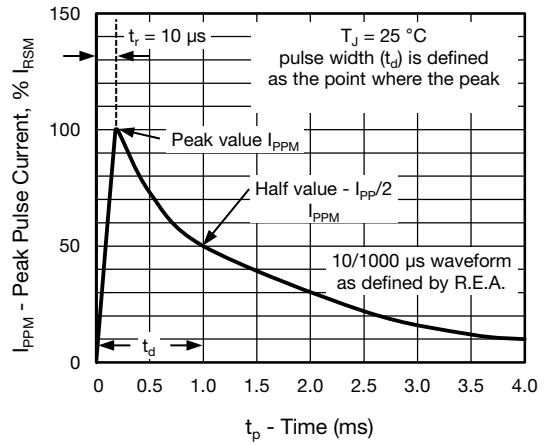

Fig. 3 - Pulse Waveform

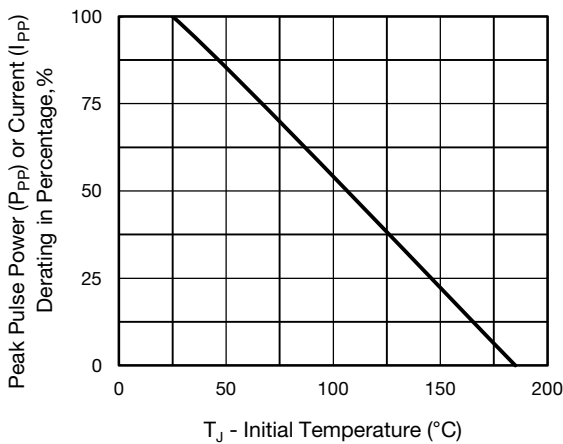

Fig. 2 - Pulse Power or Current vs. Initial Junction Temperature

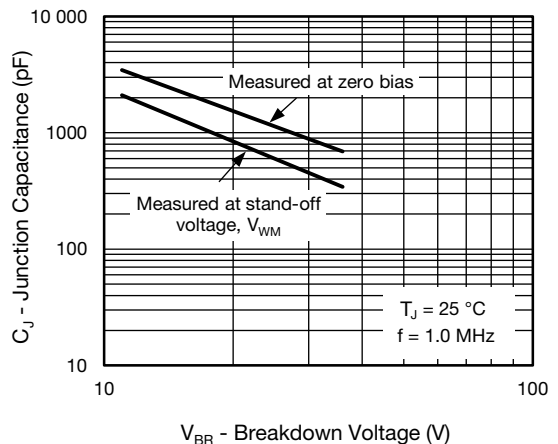

Fig. 4 - Typical Junction Capacitance

Note

- Fig.1 power calculation is based on I_{PPM} , times defined maximum clamping voltage by pulse width.



PACKAGE OUTLINE DIMENSIONS in inches (millimeters)

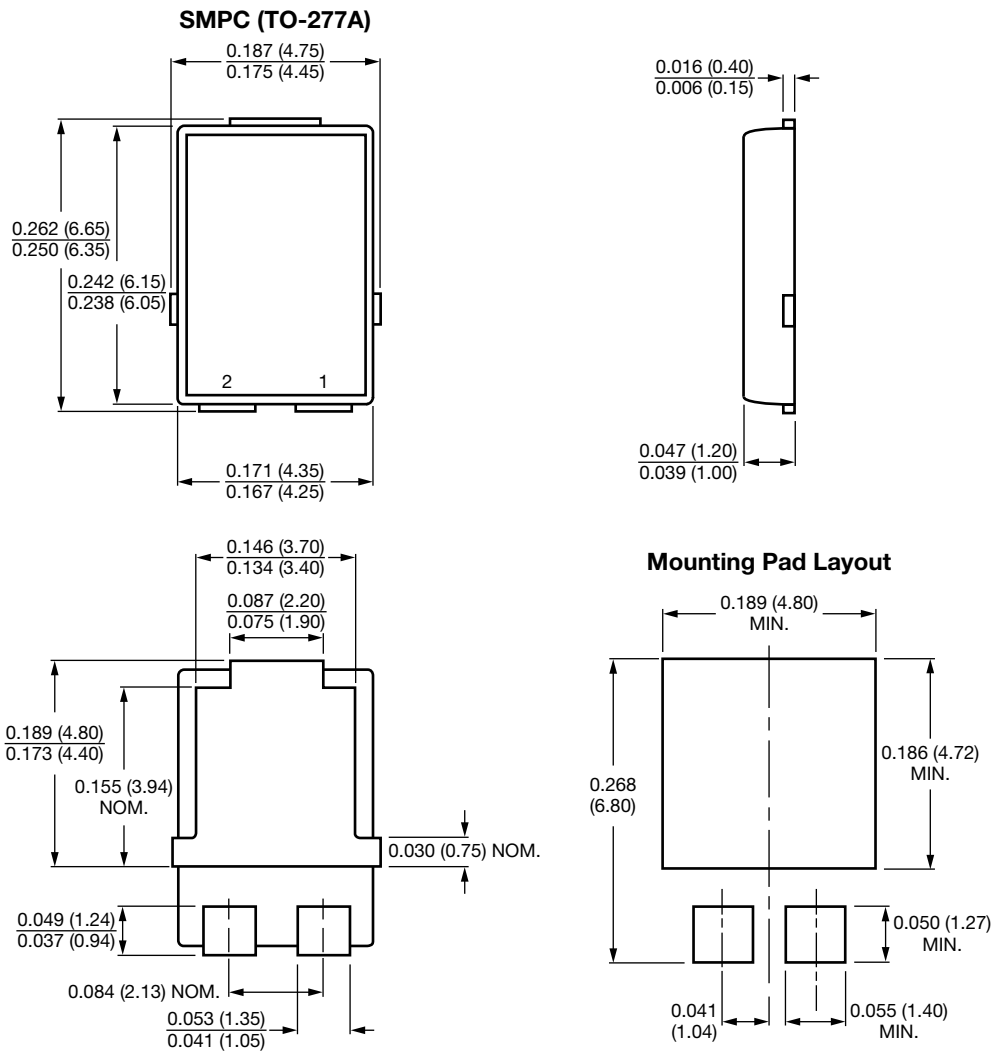

Conform to JEDEC® TO-277A



Disclaimer

ALL PRODUCT, PRODUCT SPECIFICATIONS AND DATA ARE SUBJECT TO CHANGE WITHOUT NOTICE TO IMPROVE RELIABILITY, FUNCTION OR DESIGN OR OTHERWISE.

Vishay Intertechnology, Inc., its affiliates, agents, and employees, and all persons acting on its or their behalf (collectively, "Vishay"), disclaim any and all liability for any errors, inaccuracies or incompleteness contained in any datasheet or in any other disclosure relating to any product.

Vishay makes no warranty, representation or guarantee regarding the suitability of the products for any particular purpose or the continuing production of any product. To the maximum extent permitted by applicable law, Vishay disclaims (i) any and all liability arising out of the application or use of any product, (ii) any and all liability, including without limitation special, consequential or incidental damages, and (iii) any and all implied warranties, including warranties of fitness for particular purpose, non-infringement and merchantability.

Statements regarding the suitability of products for certain types of applications are based on Vishay's knowledge of typical requirements that are often placed on Vishay products in generic applications. Such statements are not binding statements about the suitability of products for a particular application. It is the customer's responsibility to validate that a particular product with the properties described in the product specification is suitable for use in a particular application. Parameters provided in datasheets and / or specifications may vary in different applications and performance may vary over time. All operating parameters, including typical parameters, must be validated for each customer application by the customer's technical experts. Product specifications do not expand or otherwise modify Vishay's terms and conditions of purchase, including but not limited to the warranty expressed therein.



Hyperlinks included in this datasheet may direct users to third-party websites. These links are provided as a convenience and for informational purposes only. Inclusion of these hyperlinks does not constitute an endorsement or an approval by Vishay of any of the products, services or opinions of the corporation, organization or individual associated with the third-party website. Vishay disclaims any and all liability and bears no responsibility for the accuracy, legality or content of the third-party website or for that of subsequent links.

Vishay products are not designed for use in life-saving or life-sustaining applications or any application in which the failure of the Vishay product could result in personal injury or death unless specifically qualified in writing by Vishay. Customers using or selling Vishay products not expressly indicated for use in such applications do so at their own risk. Please contact authorized Vishay personnel to obtain written terms and conditions regarding products designed for such applications.

No license, express or implied, by estoppel or otherwise, to any intellectual property rights is granted by this document or by any conduct of Vishay. Product names and markings noted herein may be trademarks of their respective owners.

Looking for pricing, stock, or lifecycle information?

Click below to explore more details on WIN SOURCE:

-  [View TPC33CAHM3/H on WIN SOURCE](#)
-  [Vishay Information](#)

Optimize Your Supply Chain with WIN SOURCE Solutions

-  Global Sourcing Solution
-  Obsolete Management
-  Cost Control Management
-  Shortage Management
-  Alternative Solution
-  Excess Inventory Management