



**THE DATASHEET OF
CDCVF25081PW**



CDCVF25081 3.3-V PHASED-LOCK LOOP CLOCK DRIVER

SCAS671A – OCTOBER 2001 – REVISED FEBRUARY 2003

- Phase-Locked Loop-Based Zero-Delay Buffer
- Operating Frequency: 8 MHz to 200 MHz
- Low Jitter (Cycle-Cycle): ± 100 ps Over the Range 66 MHz to 200 MHz
- Distributes One Clock Input to Two Banks of Four Outputs
- Auto Frequency Detection to Disable Device (Power Down Mode)
- Consumes Less Than 20 μ A in Power Down Mode
- Operates From Single 3.3-V Supply
- Industrial Temperature Range -40°C to 85°C
- 25- Ω On-Chip Series Damping Resistors
- No External RC Network Required
- Spread Spectrum Clock Compatible (SSC)
- Available in 16-Pin TSSOP or 16-Pin SOIC Packages

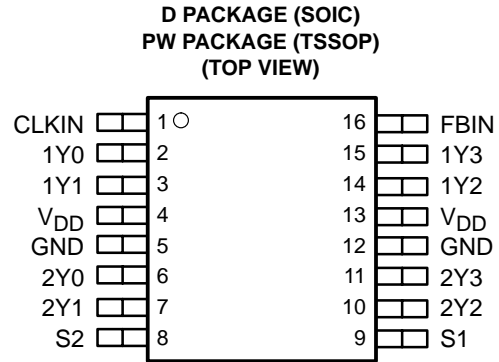

description

The CDCVF25081 is a high-performance, low-skew, low-jitter, phase-lock loop clock driver. It uses a PLL to precisely align, in both frequency and phase, the output clocks to the input clock signal. The CDCVF25081 operates from a nominal supply voltage of 3.3 V. The device also includes integrated series-damping resistors in the output drivers that make it ideal for driving point-to-point loads.

Two banks of four outputs each provide low-skew, low-jitter copies of CLKIN. All outputs operate at the same frequency. Output duty cycles are adjusted to 50%, independent of duty cycle at CLKIN. The device automatically goes into power-down mode when no input signal is applied to CLKIN and the outputs go into a low state. Unlike many products containing PLLs, the CDCVF25081 does not require an external RC network. The loop filter for the PLL is included on-chip, minimizing component count, space, and cost.

Because it is based on a PLL circuitry, the CDCVF25081 requires a stabilization time to achieve phase lock of the feedback signal to the reference signal. This stabilization is required following power up and application of a fixed-frequency signal at CLKIN and any following changes to the PLL reference.

The CDCVF25081 is characterized for operation from -40°C to 85°C .

FUNCTION TABLE

S2	S1	1Y0–1Y3	2Y0–2Y3	OUTPUT SOURCE	PLL SHUTDOWN
0	0	Hi-Z	Hi-Z	N/A.	Yes
0	1	Active	Hi-Z	PLL [†]	No
1	0	Active	Active	Input clock (PLL bypass)	Yes
1	1	Active	Active	PLL [†]	No

[†] CLK input frequency < 2 MHz switches the outputs to low level



Please be aware that an important notice concerning availability, standard warranty, and use in critical applications of Texas Instruments semiconductor products and disclaimers thereto appears at the end of this data sheet.

PRODUCTION DATA information is current as of publication date. Products conform to specifications per the terms of Texas Instruments standard warranty. Production processing does not necessarily include testing of all parameters.

**TEXAS
INSTRUMENTS**

POST OFFICE BOX 655303 • DALLAS, TEXAS 75265

Copyright © 2001 – 2003, Texas Instruments Incorporated

CDCVF25081

3.3-V PHASED-LOCK LOOP CLOCK DRIVER

SCAS671A – OCTOBER 2001 – REVISED FEBRUARY 2003

Terminal Functions

TERMINAL NAME	PIN NO.	TYPE	DESCRIPTION
1Y[0:3]	2, 3, 14, 15	O	Bank 1Yn clock outputs. These outputs are low-skew copies of CLKIN. Each output has an integrated 25-Ω series-damping resistor.
2Y[0:3]	6, 7, 10, 11	O	Bank 2Yn clock outputs. These outputs are low-skew copies of CLKIN. Each output has an integrated 25-Ω series-damping resistor.
CLKIN	1	I	Clock input. CLKIN provides the clock signal to be distributed by the CDCVF25081 clock driver. CLKIN is used to provide the reference signal to the integrated PLL that generates the output signal. CLKIN must have a fixed frequency and phase in order for the PLL to acquire lock. Once the circuit is powered up and a valid signal is applied, a stabilization time is required for the PLL to phase lock the feedback signal to CLKIN.
FBIN	16	I	Feedback input. FBIN provides the feedback signal to the internal PLL. FBIN must be wired to one of the outputs to complete the feedback loop of the internal PLL. The integrated PLL synchronizes the FBIN and output signal so there is nominally zero-delay from input clock to output clock.
GND	5, 12	Ground	Ground
S1, S2	9, 8	I	Select pins to determine mode of operation. See the <i>FUNCTION TABLE</i> for mode selection options.
V _{DD}	4, 13	Power	Supply voltage. The supply voltage range is 3 V to 3.6 V



POST OFFICE BOX 655303 • DALLAS, TEXAS 75265

functional block diagram

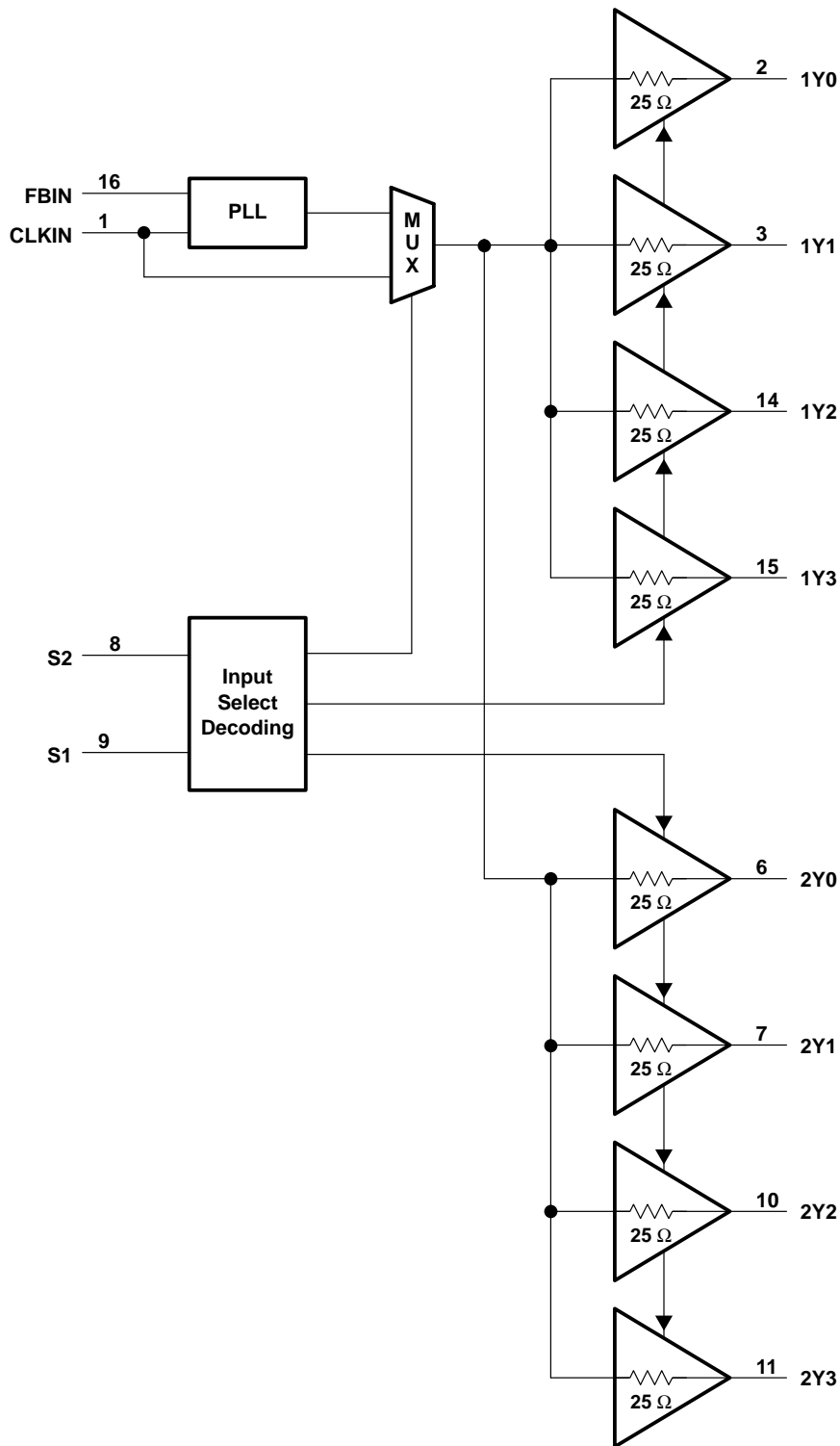

CDCVF25081

3.3-V PHASED-LOCK LOOP CLOCK DRIVER

SCAS671A – OCTOBER 2001 – REVISED FEBRUARY 2003

absolute maximum ratings over operating free-air temperature (unless otherwise noted)†

Supply voltage range, V_{DD}	-0.5 V to 4.6 V
Input voltage range, V_I (see Notes 1 and 2)	-0.5 V to 4.6 V
Output voltage range, V_O (see Notes 1 and 2)	-0.5 V to $V_{DD} + 0.5$ V
Input clamp current, I_{IK} ($V_I < 0$)	-50 mA
Output clamp current, I_{OK} ($V_O < 0$)	-50 mA
Continuous total output current, I_O ($V_O = 0$ to V_{DD})	-50 mA
Package thermal impedance, θ_{JA} (see Note 3): PW package	147°C/W
D package	112°C/W
Storage temperature range, T_{stg}	-65°C to 150°C

† Stresses beyond those listed under “absolute maximum ratings” may cause permanent damage to the device. These are stress ratings only, and functional operation of the device at these or any other conditions beyond those indicated under “recommended operating conditions” is not implied. Exposure to absolute-maximum-rated conditions for extended periods may affect device reliability.

- NOTES: 1. The input and output negative voltage ratings may be exceeded if the input and output clamp-current ratings are observed.
 2. This value is limited to 4.6 V maximum.
 3. The package thermal impedance is calculated in accordance with JESD 51.

recommended operating conditions

	MIN	NOM	MAX	UNIT
Supply voltage, V_{DD}	3	3.3	3.6	V
Low level input voltage, V_{IL}			0.8	V
High level input voltage, V_{IH}	2			V
Input voltage, V_I	0		3.6	V
High-level output current, I_{OH}			-12	mA
Low-level output current, I_{OL}			12	mA
Operating free-air temperature, T_A	-40		85	°C

timing requirements over recommended ranges of supply voltage, load and operating free-air temperature

	MIN	NOM	MAX	UNIT
Clock frequency, f_{clk}	$C_L = 25$ pF	8	100	MHz
	$C_L = 15$ pF	66	200	



CDCVF25081

3.3-V PHASED-LOCK LOOP CLOCK DRIVER

SCAS671A – OCTOBER 2001 – REVISED FEBRUARY 2003

electrical characteristics over recommended operating free-air temperature range (unless otherwise noted)

PARAMETER		TEST CONDITIONS	MIN	TYP†	MAX	UNIT
V_{IK}	Input voltage	$V_{DD} = 3\text{ V}$, $I_I = -18\text{ mA}$			-1.2	V
I_I	Input current	$V_I = 0\text{ V}$ or V_{DD}			±5	μA
$I_{PD}‡$	Power down current	$f_{CLKIN} = 0\text{ MHz}$, $V_{DD} = 3.3\text{ V}$			20	μA
I_{OZ}	Output 3-state	$V_O = 0\text{ V}$ or V_{DD} , $V_{DD} = 3.6\text{ V}$			±5	μA
C_I	Input capacitance at FBIN, CLKIN	$V_I = 0\text{ V}$ or V_{DD}		4		pF
C_I	Input capacitance at S1, S2	$V_I = 0\text{ V}$ or V_{DD}		2.2		pF
C_O	Output capacitance	$V_I = 0\text{ V}$ or V_{DD}		3		pF
V_{OH}	High-level output voltage	$V_{DD} = \text{min to max}$, $I_{OH} = -100\text{ μA}$	$V_{DD} - 0.2$			V
		$V_{DD} = 3\text{ V}$, $I_{OH} = -12\text{ mA}$	2.1			
		$V_{DD} = 3\text{ V}$, $I_{OH} = -6\text{ mA}$	2.4			
V_{OL}	Low-level output voltage	$V_{DD} = \text{min to max}$, $I_{OL} = 100\text{ μA}$			0.2	V
		$V_{DD} = 3\text{ V}$, $I_{OL} = 12\text{ mA}$			0.8	
		$V_{DD} = 3\text{ V}$, $I_{OL} = 6\text{ mA}$			0.55	
I_{OH}	High-level output current	$V_{DD} = 3\text{ V}$, $V_O = 1\text{ V}$			-24	mA
		$V_{DD} = 3.3\text{ V}$, $V_O = 1.65\text{ V}$			-30	
		$V_{DD} = 3.6\text{ V}$, $V_O = 3.135\text{ V}$			-15	
I_{OL}	Low-level output current	$V_{DD} = 3\text{ V}$, $V_O = 1.95\text{ V}$			26	mA
		$V_{DD} = 3.3\text{ V}$, $V_O = 1.65\text{ V}$			33	
		$V_{DD} = 3.6\text{ V}$, $V_O = 0.4\text{ V}$			14	

† All typical values are at respective nominal V_{DD} .

‡ For I_{DD} over frequency see Figure 7.

CDCVF25081

3.3-V PHASED-LOCK LOOP CLOCK DRIVER

SCAS671A – OCTOBER 2001 – REVISED FEBRUARY 2003

switching characteristics over recommended operating free-air temperature range (unless otherwise noted)

PARAMETER		TEST CONDITIONS	MIN	TYP†	MAX	UNIT
t _(lock)	PLL lock time	f = 100 MHz		10		μs
t _(phoffset)	Phase offset (CLKIN to FBIN)	f = 8 MHz to 66 MHz, V _{th} = V _{DD} /2 (see Note 5)	-200		200	ps
		f = 66 MHz to 200 MHz, V _{th} = V _{DD} /2 (see Note 5)	-150		150	
t _{PLH}	Low-to-high level output propagation delay	S2 = High, S1 = Low (PLL bypass)	2.5		6	ns
t _{PHL}	High-to-low level output propagation delay	f = 1 MHz, C _L = 25 pF				
t _{sk(o)}	Output skew (Y _n to Y _n) (see Note 4)				150	ps
t _{sk(pp)}	Part-to-part skew	S2 = high, S1 = high (PLL mode)			600	ps
		S2 = high, S1 = low (PLL bypass)			700	
t _{jit(cc)}	Jitter (cycle-to-cycle)	f = 66 MHz to 200 MHz, C _L = 15 pF			±100	ps
		f = 66 MHz to 100 MHz, C _L = 25 pF f = 8 MHz to 66 MHz (see Figure 6)			±150	
odc	Output duty cycle	f = 8 MHz to 200 MHz	43%		57%	
t _{sk(p)}	Pulse skew	S2 = High, S1 = low (PLL bypass) f = 1 MHz, C _L = 25 pF			0.7	ns
t _r	Rise time rate	C _L = 15 pF, See Figure 4	0.8		3.3	V/ns
		C _L = 25 pF, See Figure 4	0.5		2	
t _f	Fall time rate	C _L = 15 pF, See Figure 4	0.8		3.3	V/ns
		C _L = 25 pF, See Figure 4	0.5		2	

† All typical values are at respective nominal V_{DD}.

NOTES: 4. The t_{sk(o)} specification is only valid for equal loading of all outputs.

5. Similar waveform at CLKIN and FBIN are required. For phase displacement between CLKIN and Y-outputs see Figure 5.



PARAMETER MEASUREMENT INFORMATION

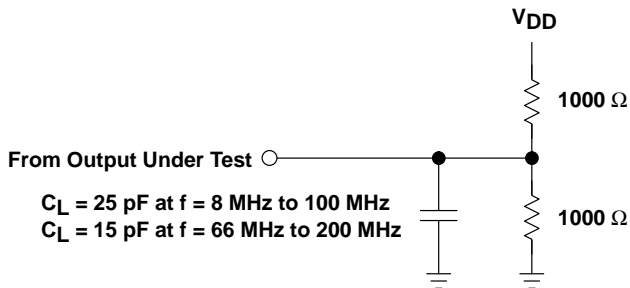

- NOTES: A. C_L includes probe and jig capacitance.
 B. All input pulses are supplied by generators having the following characteristics: $Z_O = 50 \Omega$, $t_r < 1.2 \text{ ns}$, $t_f < 1.2 \text{ ns}$.
 C. The outputs are measured one at a time with one transition per measurement.

Figure 1. Test Load Circuit

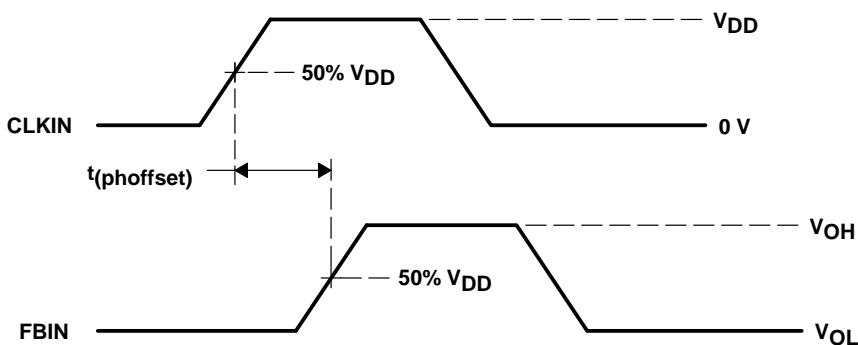
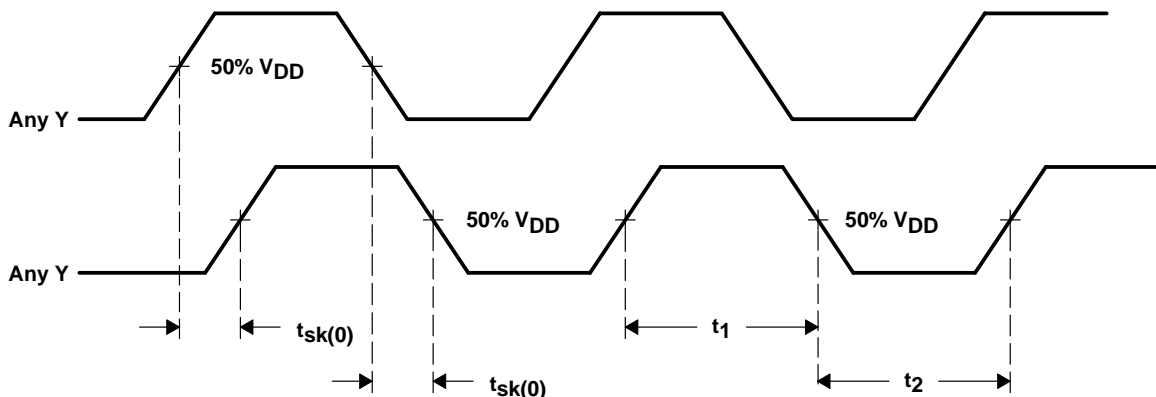

Figure 2. Voltage Thresholds for Measurements, Phase Offset (PLL Mode)



NOTE: $odc = t_1 / (t_1 + t_2) \times 100\%$

Figure 3. Output Skew and Output Duty Cycle (PLL Mode)

CDCVF25081 3.3-V PHASED-LOCK LOOP CLOCK DRIVER

SCAS671A – OCTOBER 2001 – REVISED FEBRUARY 2003

PARAMETER MEASUREMENT INFORMATION

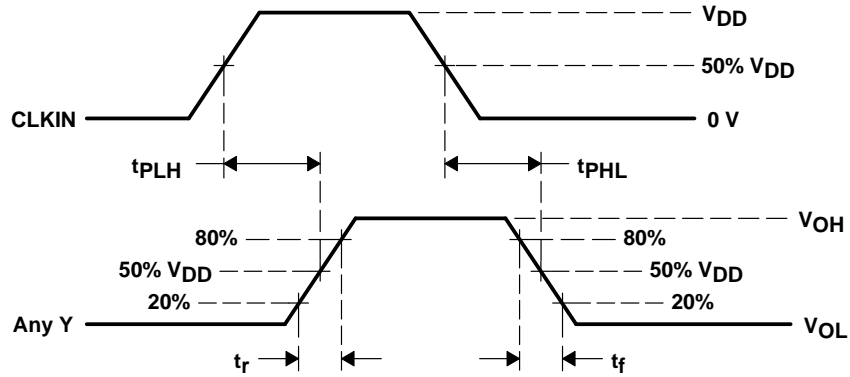

NOTE: $t_{sk(p)} = |t_{PLH} - t_{PHL}|$

Figure 4. Propagation Delay and Pulse Skew (Non-PLL Mode)

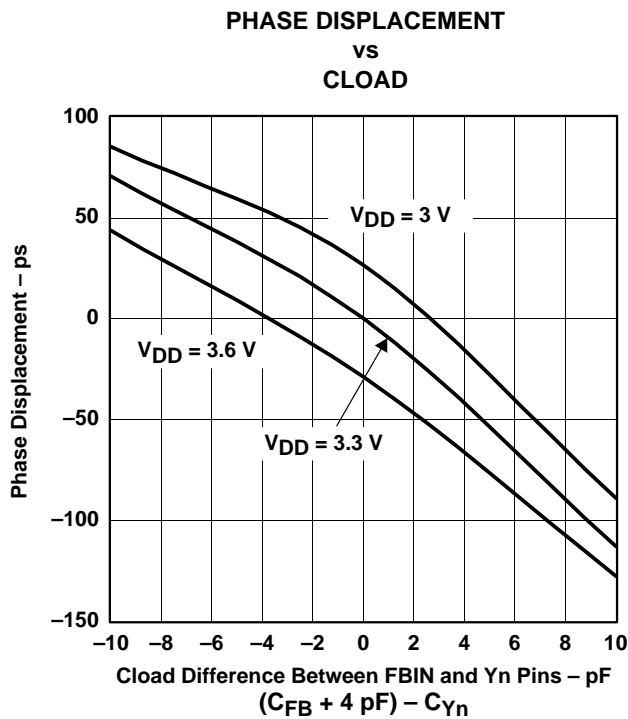

Figure 5

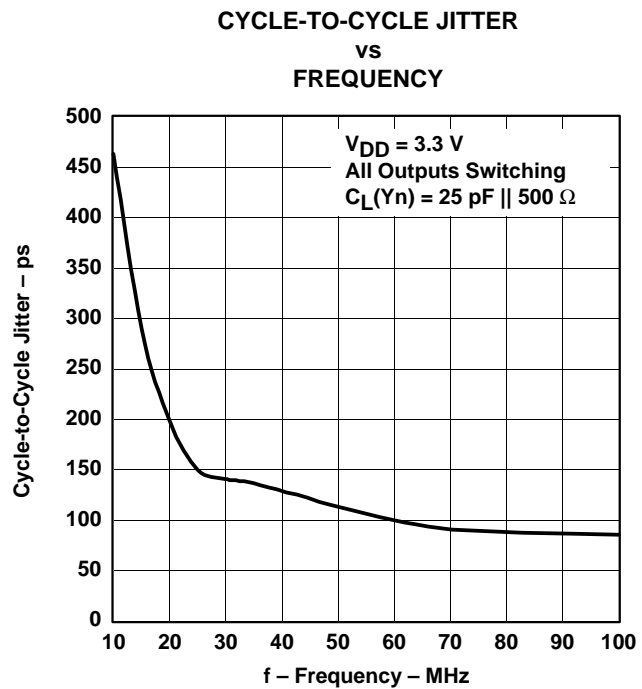
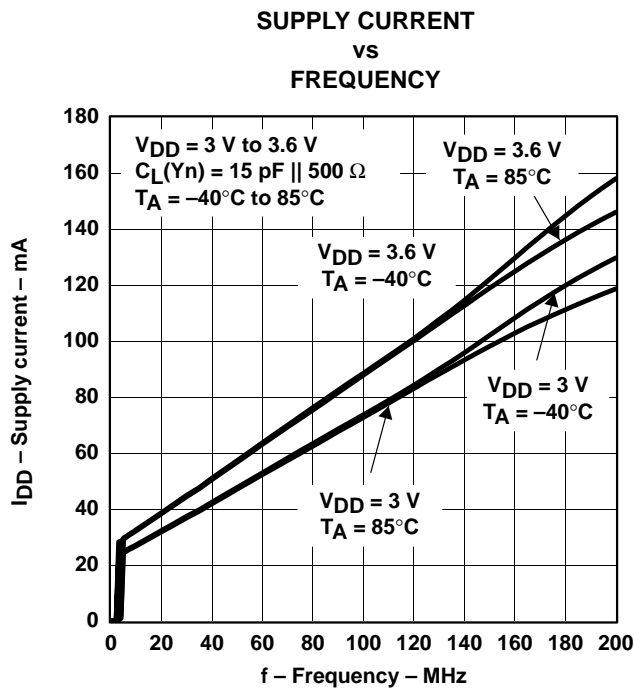

Figure 6

PARAMETER MEASUREMENT INFORMATION



PACKAGING INFORMATION

Orderable Device	Status (1)	Package Type	Package Drawing	Pins	Package Qty	Eco Plan (2)	Lead/Ball Finish	MSL Peak Temp (3)	Op Temp (°C)	Top-Side Markings (4)	Samples
CDCVF25081D	ACTIVE	SOIC	D	16	40	Green (RoHS & no Sb/Br)	CU NIPDAU	Level-1-260C-UNLIM	-40 to 85	CKV25081	Samples
CDCVF25081DG4	ACTIVE	SOIC	D	16	40	Green (RoHS & no Sb/Br)	CU NIPDAU	Level-1-260C-UNLIM	-40 to 85	CKV25081	Samples
CDCVF25081DR	ACTIVE	SOIC	D	16	2500	Green (RoHS & no Sb/Br)	CU NIPDAU	Level-1-260C-UNLIM	-40 to 85	CKV25081	Samples
CDCVF25081DRG4	ACTIVE	SOIC	D	16	2500	Green (RoHS & no Sb/Br)	CU NIPDAU	Level-1-260C-UNLIM	-40 to 85	CKV25081	Samples
CDCVF25081PW	ACTIVE	TSSOP	PW	16	90	Green (RoHS & no Sb/Br)	CU NIPDAU	Level-1-260C-UNLIM	-40 to 85	CK081	Samples
CDCVF25081PWG4	ACTIVE	TSSOP	PW	16	90	Green (RoHS & no Sb/Br)	CU NIPDAU	Level-1-260C-UNLIM	-40 to 85	CK081	Samples
CDCVF25081PWR	ACTIVE	TSSOP	PW	16	2000	Green (RoHS & no Sb/Br)	CU NIPDAU	Level-1-260C-UNLIM	-40 to 85	CK081	Samples
CDCVF25081PWRG4	ACTIVE	TSSOP	PW	16	2000	Green (RoHS & no Sb/Br)	CU NIPDAU	Level-1-260C-UNLIM	-40 to 85	CK081	Samples

(1) The marketing status values are defined as follows:

ACTIVE: Product device recommended for new designs.

LIFEBUY: TI has announced that the device will be discontinued, and a lifetime-buy period is in effect.

NRND: Not recommended for new designs. Device is in production to support existing customers, but TI does not recommend using this part in a new design.

PREVIEW: Device has been announced but is not in production. Samples may or may not be available.

OBSELETE: TI has discontinued the production of the device.

(2) Eco Plan - The planned eco-friendly classification: Pb-Free (RoHS), Pb-Free (RoHS Exempt), or Green (RoHS & no Sb/Br) - please check <http://www.ti.com/productcontent> for the latest availability information and additional product content details.

TBD: The Pb-Free/Green conversion plan has not been defined.

Pb-Free (RoHS): TI's terms "Lead-Free" or "Pb-Free" mean semiconductor products that are compatible with the current RoHS requirements for all 6 substances, including the requirement that lead not exceed 0.1% by weight in homogeneous materials. Where designed to be soldered at high temperatures, TI Pb-Free products are suitable for use in specified lead-free processes.

Pb-Free (RoHS Exempt): This component has a RoHS exemption for either 1) lead-based flip-chip solder bumps used between the die and package, or 2) lead-based die adhesive used between the die and leadframe. The component is otherwise considered Pb-Free (RoHS compatible) as defined above.

Green (RoHS & no Sb/Br): TI defines "Green" to mean Pb-Free (RoHS compatible), and free of Bromine (Br) and Antimony (Sb) based flame retardants (Br or Sb do not exceed 0.1% by weight in homogeneous material)

(3) MSL, Peak Temp. -- The Moisture Sensitivity Level rating according to the JEDEC industry standard classifications, and peak solder temperature.

⁽⁴⁾ Multiple Top-Side Markings will be inside parentheses. Only one Top-Side Marking contained in parentheses and separated by a "~" will appear on a device. If a line is indented then it is a continuation of the previous line and the two combined represent the entire Top-Side Marking for that device.

Important Information and Disclaimer:The information provided on this page represents TI's knowledge and belief as of the date that it is provided. TI bases its knowledge and belief on information provided by third parties, and makes no representation or warranty as to the accuracy of such information. Efforts are underway to better integrate information from third parties. TI has taken and continues to take reasonable steps to provide representative and accurate information but may not have conducted destructive testing or chemical analysis on incoming materials and chemicals. TI and TI suppliers consider certain information to be proprietary, and thus CAS numbers and other limited information may not be available for release.

In no event shall TI's liability arising out of such information exceed the total purchase price of the TI part(s) at issue in this document sold by TI to Customer on an annual basis.

TAPE AND REEL INFORMATION

QUADRANT ASSIGNMENTS FOR PIN 1 ORIENTATION IN TAPE

*All dimensions are nominal

Device	Package Type	Package Drawing	Pins	SPQ	Reel Diameter (mm)	Reel Width W1 (mm)	A0 (mm)	B0 (mm)	K0 (mm)	P1 (mm)	W (mm)	Pin1 Quadrant
CDCVF25081DR	SOIC	D	16	2500	330.0	16.4	6.5	10.3	2.1	8.0	16.0	Q1
CDCVF25081PWR	TSSOP	PW	16	2000	330.0	12.4	6.9	5.6	1.6	8.0	12.0	Q1

TAPE AND REEL BOX DIMENSIONS

*All dimensions are nominal

Device	Package Type	Package Drawing	Pins	SPQ	Length (mm)	Width (mm)	Height (mm)
CDCVF25081DR	SOIC	D	16	2500	350.0	350.0	43.0
CDCVF25081PWR	TSSOP	PW	16	2000	367.0	367.0	35.0

D (R-PDSO-G16)

PLASTIC SMALL OUTLINE



4211283-4/E 08/12

- NOTES:
- All linear dimensions are in millimeters.
 - This drawing is subject to change without notice.
 - Publication IPC-7351 is recommended for alternate designs.
 - Laser cutting apertures with trapezoidal walls and also rounding corners will offer better paste release. Customers should contact their board assembly site for stencil design recommendations. Refer to IPC-7525 for other stencil recommendations.
 - Customers should contact their board fabrication site for solder mask tolerances between and around signal pads.



4220204/A 02/2017

NOTES:

1. All linear dimensions are in millimeters. Any dimensions in parenthesis are for reference only. Dimensioning and tolerancing per ASME Y14.5M.
2. This drawing is subject to change without notice.
3. This dimension does not include mold flash, protrusions, or gate burrs. Mold flash, protrusions, or gate burrs shall not exceed 0.15 mm per side.
4. This dimension does not include interlead flash. Interlead flash shall not exceed 0.25 mm per side.
5. Reference JEDEC registration MO-153.

EXAMPLE BOARD LAYOUT

PW0016A

TSSOP - 1.2 mm max height

SMALL OUTLINE PACKAGE



LAND PATTERN EXAMPLE
EXPOSED METAL SHOWN
SCALE: 10X



4220204/A 02/2017

NOTES: (continued)

- 6. Publication IPC-7351 may have alternate designs.
- 7. Solder mask tolerances between and around signal pads can vary based on board fabrication site.

EXAMPLE STENCIL DESIGN

PW0016A

TSSOP - 1.2 mm max height

SMALL OUTLINE PACKAGE



SOLDER PASTE EXAMPLE
BASED ON 0.125 mm THICK STENCIL
SCALE: 10X

4220204/A 02/2017

NOTES: (continued)

8. Laser cutting apertures with trapezoidal walls and rounded corners may offer better paste release. IPC-7525 may have alternate design recommendations.
9. Board assembly site may have different recommendations for stencil design.

IMPORTANT NOTICE AND DISCLAIMER

TI PROVIDES TECHNICAL AND RELIABILITY DATA (INCLUDING DATASHEETS), DESIGN RESOURCES (INCLUDING REFERENCE DESIGNS), APPLICATION OR OTHER DESIGN ADVICE, WEB TOOLS, SAFETY INFORMATION, AND OTHER RESOURCES "AS IS" AND WITH ALL FAULTS, AND DISCLAIMS ALL WARRANTIES, EXPRESS AND IMPLIED, INCLUDING WITHOUT LIMITATION ANY IMPLIED WARRANTIES OF MERCHANTABILITY, FITNESS FOR A PARTICULAR PURPOSE OR NON-INFRINGEMENT OF THIRD PARTY INTELLECTUAL PROPERTY RIGHTS.

These resources are intended for skilled developers designing with TI products. You are solely responsible for (1) selecting the appropriate TI products for your application, (2) designing, validating and testing your application, and (3) ensuring your application meets applicable standards, and any other safety, security, or other requirements. These resources are subject to change without notice. TI grants you permission to use these resources only for development of an application that uses the TI products described in the resource. Other reproduction and display of these resources is prohibited. No license is granted to any other TI intellectual property right or to any third party intellectual property right. TI disclaims responsibility for, and you will fully indemnify TI and its representatives against, any claims, damages, costs, losses, and liabilities arising out of your use of these resources.

TI's products are provided subject to TI's Terms of Sale (www.ti.com/legal/termsofsale.html) or other applicable terms available either on ti.com or provided in conjunction with such TI products. TI's provision of these resources does not expand or otherwise alter TI's applicable warranties or warranty disclaimers for TI products.

Mailing Address: Texas Instruments, Post Office Box 655303, Dallas, Texas 75265
Copyright © 2019, Texas Instruments Incorporated

Looking for pricing, stock, or lifecycle information?

Click below to explore more details on WIN SOURCE:

 [View CDCVF25081PW](#) on WIN SOURCE

 [Texas Instruments](#) Information

Optimize Your Supply Chain with WIN SOURCE Solutions

-  Global Sourcing Solution
-  Obsolete Management
-  Cost Control Management
-  Shortage Management
-  Alternative Solution
-  Excess Inventory Management