



**THE DATASHEET OF  
RK-0505S/H6**



# Features

- High 6.4kVDC/1s isolation
- Wide operating temperature range from -40°C to +90°C without derating
- High capacitive load capability
- Continuous short circuit protection
- Efficiency up to 80%

# Unregulated Converters

## Description

The RK/H6 and RH/H6 series 1W DC/DC converters feature high 6.4kVDC isolation and an extended operating temperature range up to +90°C without derating, yet are lower cost than standard high isolation converters. They are suitable for demanding industrial and high isolation test and measurement applications.

## Selection Guide

Part Number	nom. Input Voltage Range [VDC]	Output Voltage [VDC]	Output Current [mA]	Efficiency typ. [%]	Max. Capacitive Load <sup>(1)</sup> [µF]
RK-xx3.3S/H6	5, 12, 15, 24	3.3	303	71-74	1000
RK-xx05S/H6	5, 12, 15, 24	5	200	74-77	1000
RK-xx12S/H6	5, 12, 15, 24	12	84	77-79	220
RK-xx15S/H6	5, 12, 15, 24	15	66	77-80	220
RH-xx3.3D/H6	5, 12, 15, 24	±3.3	±152	73-74	±330
RH-xx05D/H6	5, 12, 15, 24	±5	±100	74-77	±330
RH-xx12D/H6	5, 12, 15, 24	±12	±42	77-80	±100
RH-xx15D/H6	5, 12, 15, 24	±15	±33	78-80	±100

### Notes:

Note1: Max. capacitive load is tested at nominal input voltage and full load

## Model Numbering

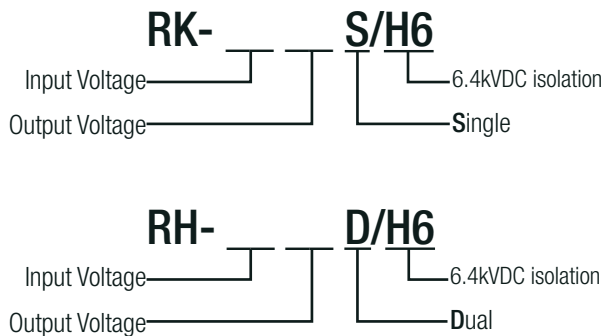

### Notes:

Note2: add suffix „K“ for Single output or suffix „H“ for Dual output

### Ordering Examples:

RK-123.3S/H6 = 12VDC Input Voltage, 3.3VDC Output Voltage, Single Output, 6.4kVDC/1s isolation  
 RH-0505D/H6 = 5VDC Input Voltage, 5VDC Output Voltage, Dual Output, 6.4kVDC/1s isolation

**RECOM**  
DC/DC Converter

## RK/H6 & RH/H6

1 Watt  
SIP7  
Single and Dual Output



UL60950-1 certified  
 CAN/CSA C22.2 No. 60950-1-07 certified  
 UL62368-1 certified  
 CAN/CSA C22.2 No. 62368-1-14 certified  
 IEC/EN60950-1 certified  
 IEC/EN62368-1 certified  
 CB report

**Specifications** (measured @ Ta= 25°C, nom. Vin, full load and after warm-up unless otherwise stated)

**BASIC CHARACTERISTICS**

Parameter	Condition	Min.	Typ.	Max.
Internal Input Filter				capacitor
Input Voltage Range			±10%	
Start-up Time			20ms	
Internal Operating Frequency			80kHz	
Minimum Load			0%	
Output Ripple and Noise	20MHz BW		60mVp-p	120mVp-p

**Efficiency vs. Load**

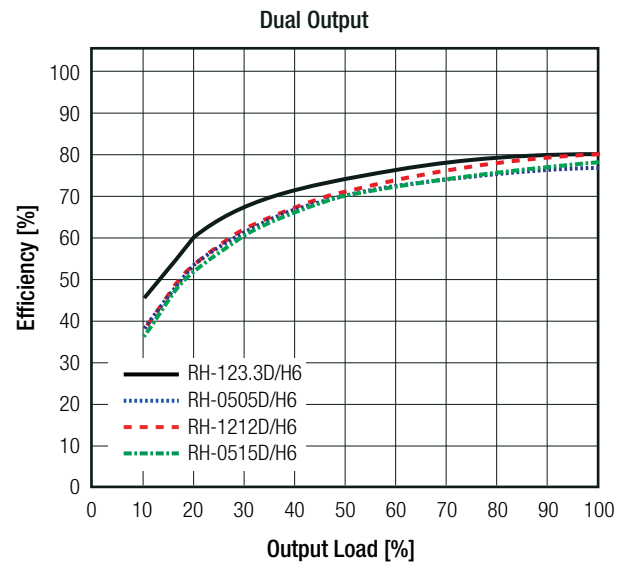
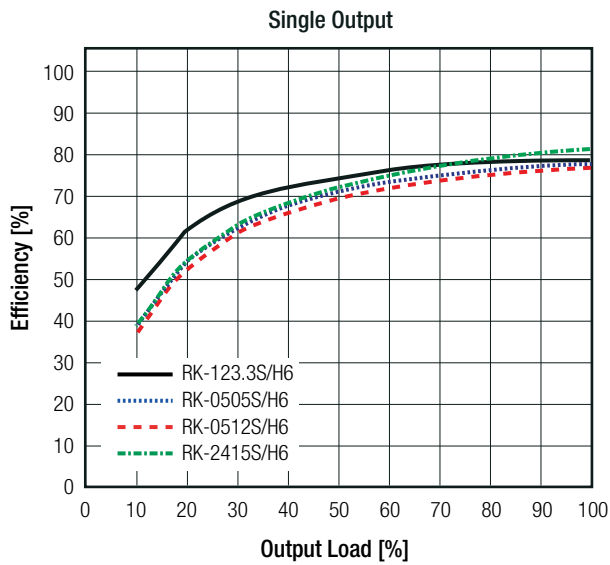

**REGULATIONS**

Parameter	Condition	Values
Output Accuracy		±5.0% max.
Line Regulation	low line to high line, max. load	±1.2% of 1.0% Vin typ.
Load Regulation <sup>(3)</sup>	10% to 100% load	10% max.

**Notes:**

Note3: Operation below 10% load will not harm the converter, but specifications may not be met

**Deviation vs. Load**

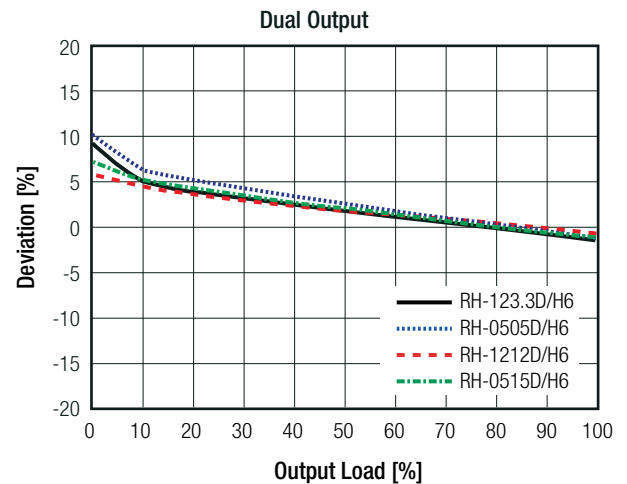
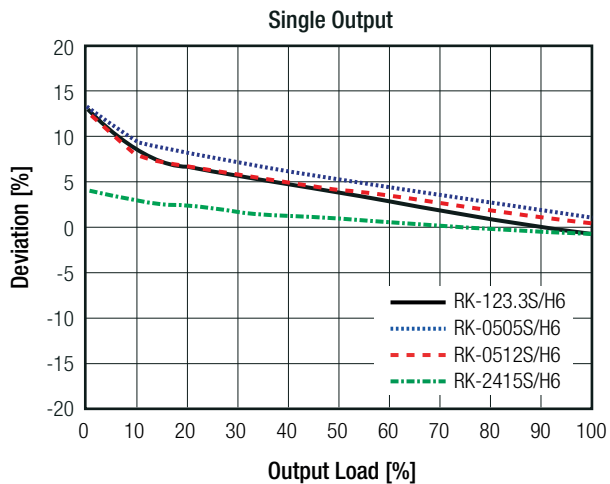

**Specifications** (measured @ Ta= 25°C, nom. Vin, full load and after warm-up unless otherwise stated)

**PROTECTIONS**

Parameter	Condition		Value
Short Circuit Protection (SCP)			continuous
Isolation Voltage <sup>(4)</sup>	I/P to O/P	tested for 1 second rated for 1 minute	6.4kVDC 5.2kVDC
Isolation Resistance			10GΩ min.
Isolation Capacitance			75pF max.
Insulation Grade			functional

**Notes:**

Note4: For repeat Hi-Pot testing, reduce the time and/or the test voltage

Note5: Refer to local safety regulations if input over-current protection is also required. Recommended fuse: slow blow type

**ENVIRONMENTAL**

Parameter	Condition		Value
Operating Temperature Range	without derating @ free air convection (see graph)		-40°C to +90°C
Operating Altitude			5000m
Operating Humidity	non-condensing		5% - 95% RH max.
MTBF	according to MIL-HDBK-217F; G.B.	+25°C +85°C	14919 x 10 <sup>3</sup> hours 9468 x 10 <sup>3</sup> hours

**Derating Graph**

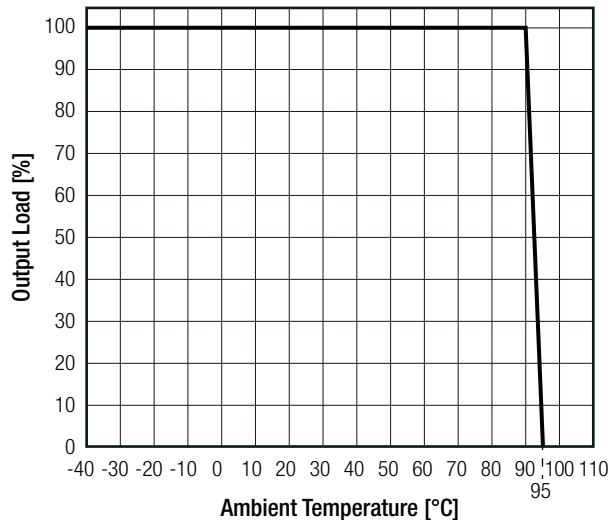

**SAFETY AND CERTIFICATIONS**

Certificate Type	Report / File Number	Standard
Information Technology Equipment - General Requirements for Safety	E224736-A25-UL	UL60950-1, 2nd Edition, 2014 CAN/CSA-C22.2 No. 60950-1-07, 2nd Edition, 2014
Audio/Video, information and communication technology equipment - Part1: Safety requirements		UL62368-1, 2nd Edition, 2014 CAN/CSA-C22.2 No. 62368-1-14, 2nd Edition, 2014
Information Technology Equipment, General Requirements for Safety (CB)	E224736-A26-CB-1	IEC60950-1:2005, 2nd Edition + A2:2013
Information Technology Equipment, General Requirements for Safety		EN60950-1:2006 + A2:2013
Audio/video, information and communication technology equipment Part 1: safety requirements (CB)	OFF-4787079973-A-2	IEC62368-1:2014, 2nd Edition
Audio/video, information and communication technology equipment Part 1: safety requirements		EN62368-1:2014

continued on next page

### Specifications (measured @ Ta= 25°C, nom. Vin, full load and after warm-up unless otherwise stated)

Certificate Type	Report / File Number	Standard
EAC	RU-AT.49.09571	TP TC 004/2011
RoHS 2		RoHS-2011/65/EU + AM-2015/863

EMI Compliance	Condition	Standard / Criterion
Electromagnetic compatibility of multimedia equipment - Emission requirements	with external filter (see filter suggestion below)	EN55032, Class B EN55032, Class A

### EMC Filter Suggestion according to EN55032

#### Single Output

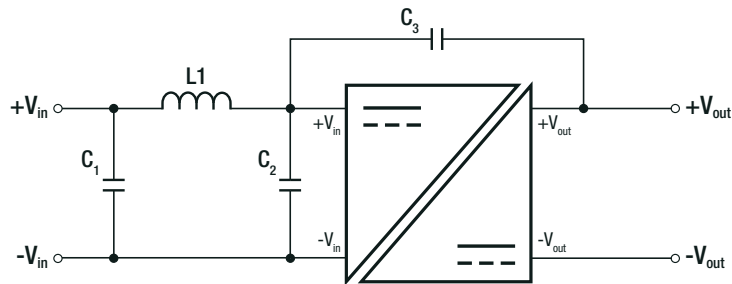

#### Component List Class A

MODEL	C1	L1	C2	C3
RK-0505S/H6	10µF 100V MLCC	<a href="#">12µH choke</a> <a href="#">RLS-126</a>	N/A	N/A
RK-0515S/H6				
RK-2405S/H6				

#### Component List Class B

MODEL	C1	L1	C2	C3
RK-0505S/H6	10µF 100V MLCC	<a href="#">12µH choke</a> <a href="#">RLS-126</a>	4.7µF 50V MLCC	N/A
RK-0515S/H6				2.2nF
RK-2405S/H6				

#### Dual Output

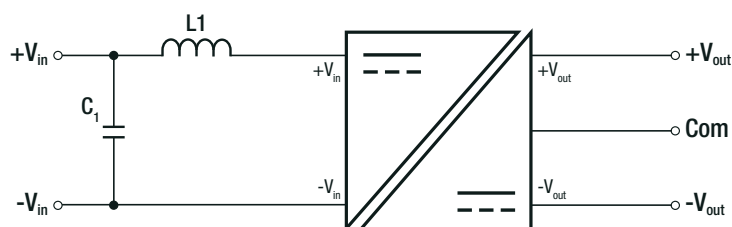

#### Component List Class A

MODEL	C1	L1
RH-0505D/H6	1µF 100V MLCC	<a href="#">68µH choke</a> <a href="#">RLS-686</a>
RH-1205D/H6		
RH-1212D/H6		
RH-2405D/H6		

#### Component List Class B

MODEL	C1	L1
RH-0505D/H6	4.7µF 50V MLCC	<a href="#">68µH choke</a> <a href="#">RLS-686</a>
RH-1205D/H6		
RH-1212D/H6		
RH-2405D/H6		

#### Notes:

Note6: Filter suggestions are valid for indicated part numbers only. For other part numbers, please contact RECOM tech support for advice

### DIMENSION and PHYSICAL CHARACTERISTICS

Parameter	Type	Value
Material	case potting	non-conductive black plastic, (UL94 V-0) epoxy, (UL94 V-0)
Dimension (LxWxH)		19.65 x 7.05 x 10.2mm
Weight		2.7g typ.

continued on next page

Specifications (measured @ Ta= 25°C, nom. Vin, full load and after warm-up unless otherwise stated)

Dimension Drawing (mm)

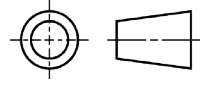
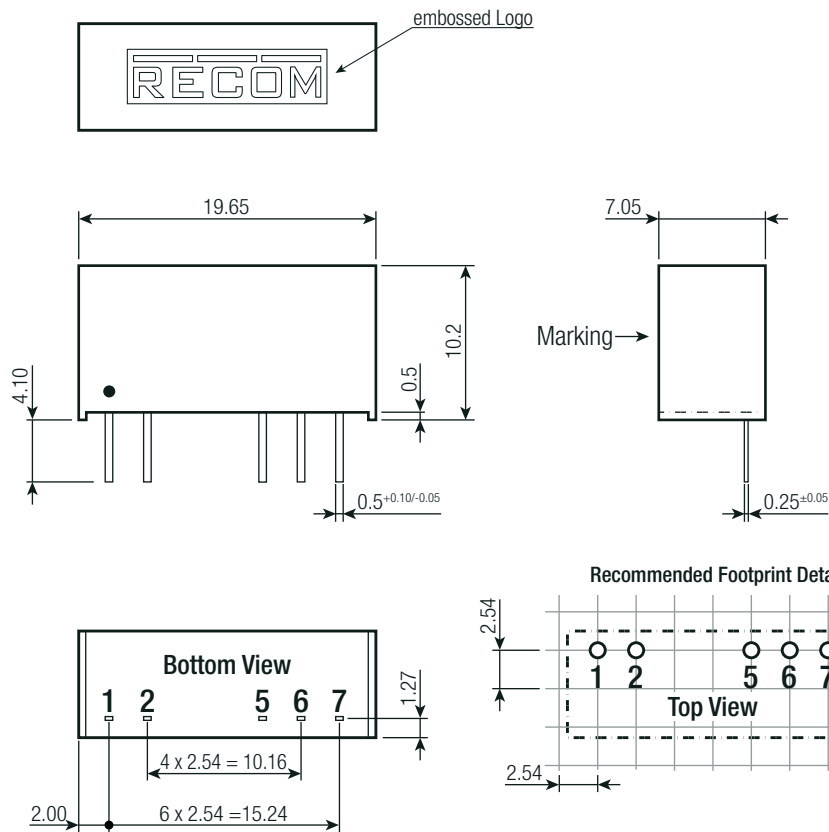

Pinning information

Pin #	Single	Dual
1	+Vin	+Vin
2	-Vin	-Vin
5	-Vout	-Vout
6	no pin	Com
7	+Vout	+Vout

Tolerance:  
xx.x= ±0.5mm  
xx.xx= ±0.25mm



PACKAGING INFORMATION

Parameter	Type	Value
Packaging Dimension (LxWxH)	tube	520.0 x 16.5 x 9.0mm
Packaging Quantity	tube	25pcs
Storage Temperature Range		-55°C to +125°C
Storage Humidity	non-condensing	95% RH max.

The product information and specifications may be subject to changes even without prior written notice. The product has been designed for various applications; its suitability lies in the responsibility of each customer. The products are not authorized for use in safety-critical applications without RECOM's explicit written consent. A safety-critical application is an application where a failure may reasonably be expected to endanger or cause loss of life, inflict bodily harm or damage property. The applicant shall indemnify and hold harmless RECOM, its affiliated companies and its representatives against any damage claims in connection with the unauthorized use of RECOM products in such safety-critical applications.

## Looking for pricing, stock, or lifecycle information?

Click below to explore more details on WIN SOURCE:

-  [View RK-0505S/H6 on WIN SOURCE](#)
-  [Recom Power Information](#)

## Optimize Your Supply Chain with WIN SOURCE Solutions

-  Global Sourcing Solution
-  Obsolete Management
-  Cost Control Management
-  Shortage Management
-  Alternative Solution
-  Excess Inventory Management