



**THE DATASHEET OF
RT9018A-10GSP**



Maximum 3A, Ultra Low Dropout Regulator

General Description

The RT9018A/B is a high performance positive voltage regulator designed for use in applications requiring very low Input voltage and very low dropout voltage at up to 3A(Peak). It operates with a VIN as low as 1.4V and VDD voltage 3V with output voltage programmable as low as 0.8V. The significant feature includes ultra low dropout, ideal for applications where VOUT is very close to VIN. Additionally, there is an enable pin to further reduce power dissipation while shutdown. The RT9018A/B provides excellent regulation over variations in line, load and temperature. and provides a power OK signal to indicate if the voltage level of Vo reaches 90% of its rating value.

The RT9018A/B is available in the SOP-8 (Exposed Pad) and WDFN-10L 3x3 packages with 1V, 1.05V, 1.2V, 1.5V, 1.8V and 2.5V internally preset outputs that are also adjustable using external resistors.

Ordering Information

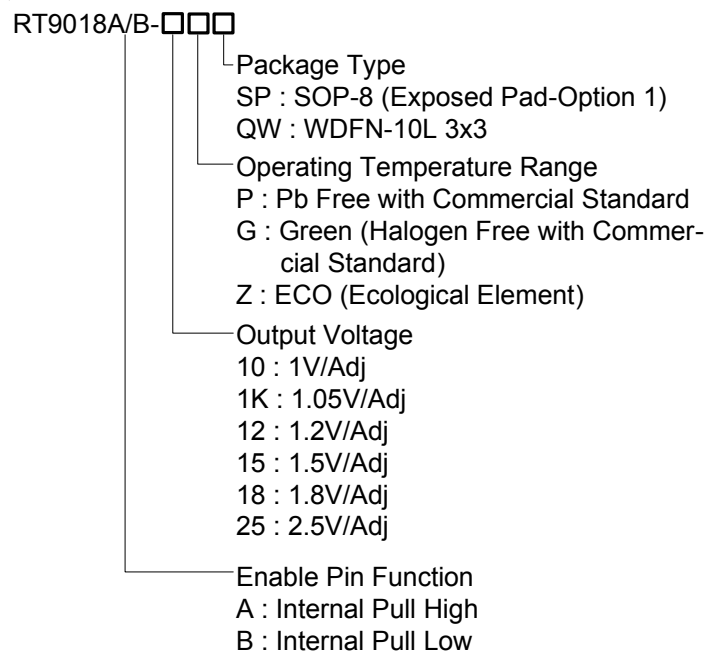

Note :

Richtek Green products are :

- ▶ RoHS compliant and compatible with the current requirements of IPC/JEDEC J-STD-020.
- ▶ Suitable for use in SnPb or Pb-free soldering processes.

Features

- Maximum 3A Low-Dropout Voltage Regulator
- High Accuracy Output Voltage $\pm 1.5\%$
- Typically 220mV Dropout at 3A
- Power Good Output
- Output Voltage Pull Low Resistance when Disable
- Thermal and Over Current Protection
- RoHS Compliant and 100% Lead (Pb)-Free

Applications

- Front Side Bus VTT (1.2V/3A)
- Notebook PC Applications
- Motherboard Applications

Marking Information

For marking information, contact our sales representative directly or through a Richtek distributor located in your area, otherwise visit our website for detail.

Pin Configurations

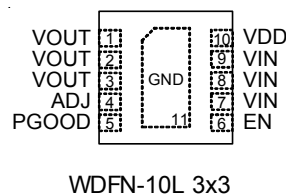
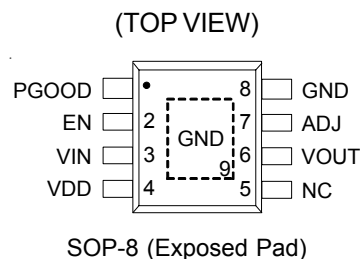

Pin Description

Pin No.		Pin Name	Pin Function
PSOP-8	WDFN 3x3		
3	7, 8, 9	VIN	Supply Input Voltage.
2	6	EN	Chip Enable (Active-High).
4	10	VDD	Supply Voltage of Control Circuitry.
1	5	PGOOD	Power Good Open Drain Output.
7	4	ADJ	Set the output voltage by the internal feedback resistors when ADJ is grounded. If external feedback resistors is used, $V_{OUT} = 0.8V \times (R1 + R2)/R2$.
6	1, 2, 3	VOUT	Output Voltage.
5	--	NC	No Internal Connection.
8, Exposed Pad (9)	Exposed Pad (11)	GND	Ground. The exposed pad must be soldered to a large PCB and connected to GND for maximum power dissipation.

Typical Application Circuit

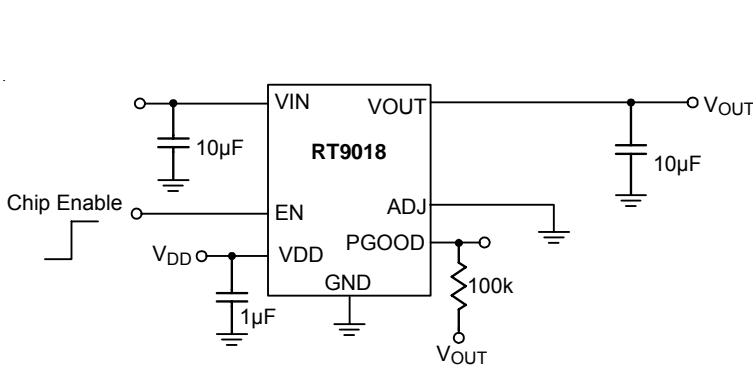

Figure 1. Fixed Voltage Regulator

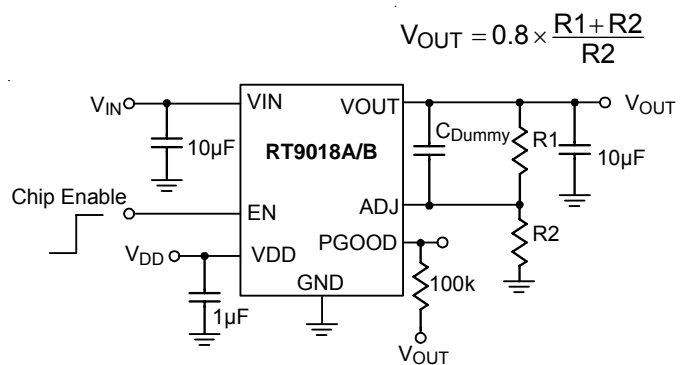
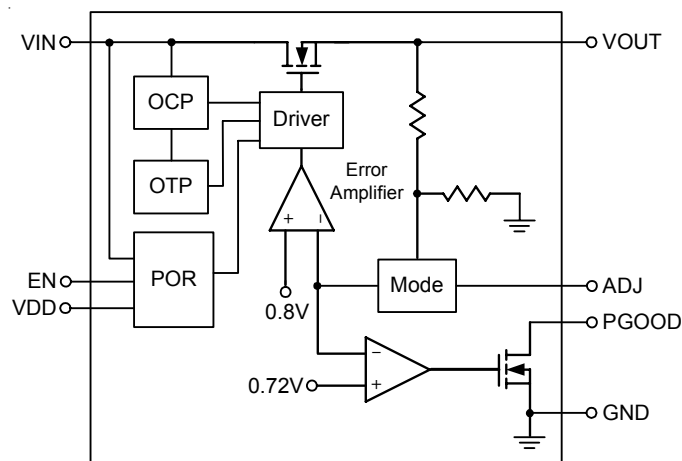

Figure 2. Adjustable Voltage Regulator

Function Block Diagram



Absolute Maximum Ratings (Note 1)

- Supply Voltage, V_{IN} ----- 1V to 6V
- Control Voltage, V_{DD} ----- 3V to 6V
- Output Voltage, V_{OUT} ----- 0.8 to 6V
- Power Dissipation, P_D @ $T_A = 25^\circ\text{C}$
 - SOP-8 (Exposed Pad) ----- 1.33W
 - WDFN-10L 3x3 ----- 1.67W
- Package Thermal Resistance (Note 2)
 - SOP-8 (Exposed Pad), θ_{JA} ----- 75°C/W
 - SOP-8 (Exposed Pad), θ_{JC} ----- 15°C/W
 - WDFN-10L 3x3, θ_{JA} ----- 60°C/W
- Junction Temperature ----- 150°C
- Lead Temperature (Soldering, 10 sec.) ----- 260°C
- Storage Temperature Range ----- -65°C to 150°C
- ESD Susceptibility (Note 3)
 - HBM (Human Body Mode) ----- 2kV
 - MM (Machine Mode) ----- 200V

Recommended Operating Conditions (Note 4)

- Supply Voltage, V_{IN} ----- 1.4V to 5.5V
- Control Voltage, V_{DD} ($V_{DD} \geq V_{OUT} + 1.5V$) ----- 3V to 5.5V
- Junction Temperature Range ----- -40°C to 125°C
- Ambient Temperature Range ----- -40°C to 85°C

Electrical Characteristics

($V_{IN} = V_{OUT} + 500\text{mV}$, $V_{EN} = V_{DD} = 5V$, $C_{IN} = C_{OUT} = 10\mu\text{F}$, $T_A = T_J = 25^\circ\text{C}$, unless otherwise specified)

Parameter	Symbol	Test Conditions	Min	Typ	Max	Unit
POR Threshold			2.4	2.7	3	V
POR Hysteresis			0.15	0.2	--	V
Adjustable Pin Threshold	V_{TH_ADJ}	$I_{OUT} = 1\text{mA}$	--	0.2	0.4	V
Reference Voltage (ADJ Pin Voltage)	V_{ADJ}	$I_{OUT} = 1\text{mA}$	0.788	0.8	0.812	V
Fixed Output Voltage Range	ΔV_{OUT}		-1.5	0	+1.5	%
Line Regulation (V_{IN})	ΔV_{LINE_IN}	$V_{IN} = V_{OUT} + 0.5V$ to $5V$, $I_{OUT} = 1\text{mA}$	--	0.2	0.6	%
Load Regulation (Note 7)	ΔV_{LOAD}	$V_{IN} = V_{OUT} + 1V$, $I_{OUT} = 1\text{mA}$ to $3A$	--	0.2	1	%
Dropout Voltage (Note 5)	V_{DROP}	$I_{OUT} = 2A$	--	150	250	mV
		$I_{OUT} = 3A$	--	210	350	mV
Quiescent Current (Note 6)	I_Q	$V_{DD} = 5.5V$	--	0.6	1.2	mA
Current Limit	I_{LIM}		3.2	4.5	--	A
Short Circuit Current		$V_{OUT} < 0.2V$	0.5	1.8	--	A
In-rush Current		$C_{OUT} = 10\mu\text{F}$, Enable Start-up	--	0.6	--	A
V_{OUT} Pull Low Resistance		$V_{EN} = 0V$	--	150	--	Ω

To be continued

Parameter	Symbol	Test Conditions	Min	Typ	Max	Unit	
Chip Enable							
EN Input Bias Current	I_{EN}	$V_{EN} = 0V$	--	12	--	μA	
VDD Shutdown Current	RT9018A	$V_{EN} = 0V$	--	10	20	μA	
	RT9018B						--
EN Threshold	Logic-Low Voltage	V_{ENL}	$V_{DD} = 5V$	--	--	0.2	V
	Logic-High Voltage	V_{ENH}	$V_{DD} = 5V$	1.2	--	--	
Power Good							
PGOOD Rising Threshold			--	90	93	%	
PGOOD Hysteresis			3	10	--	%	
PGOOD Sink Capability		$I_{PGOOD} = 10mA$	--	0.2	0.4	V	
PGOOD Delay			0.5	1.5	5	ms	
Thermal Protection							
Thermal Shutdown Temperature	T_{SD}		--	160	--	$^{\circ}C$	
Thermal Shutdown Hysteresis	ΔT_{SD}		--	30	--	$^{\circ}C$	
Thermal Shutdown Temperature Fold-back		$V_{OUT} < 0.4V$	--	110	--	$^{\circ}C$	

Note 1. Stresses listed as the above "Absolute Maximum Ratings" may cause permanent damage to the device. These are for stress ratings. Functional operation of the device at these or any other conditions beyond those indicated in the operational sections of the specifications is not implied. Exposure to absolute maximum rating conditions for extended periods may remain possibility to affect device reliability.

Note 2. θ_{JA} is measured in the natural convection at $T_A = 25^{\circ}C$ on a high effective thermal conductivity test board (4 Layers, 2S2P) of JEDEC 51-7 thermal measurement standard. The case point of θ_{JC} is on the expose pad for SOP-8 (Exposed Pad) package.

Note 3. Devices are ESD sensitive. Handling precaution recommended.

Note 4. The device is not guaranteed to function outside its operating conditions.

Note 5. The dropout voltage is defined as $V_{IN} - V_{OUT}$, which is measured when V_{OUT} is $V_{OUT(NORMAL)} - 100mV$.

Note 6. Quiescent, or ground current, is the difference between input and output currents. It is defined by $I_Q = I_{IN} - I_{OUT}$ under no load condition ($I_{OUT} = 0mA$). The total current drawn from the supply is the sum of the load current plus the ground pin current.

Note 7. Regulation is measured at constant junction temperature by using a 2ms current pulse. Devices are tested for load regulation in the load range from 1mA to 3A.

Typical Operating Characteristics

Load Transient Response

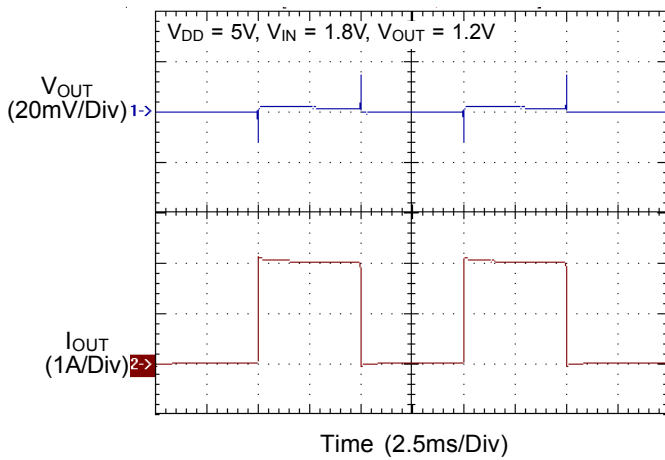

Load Transient Response

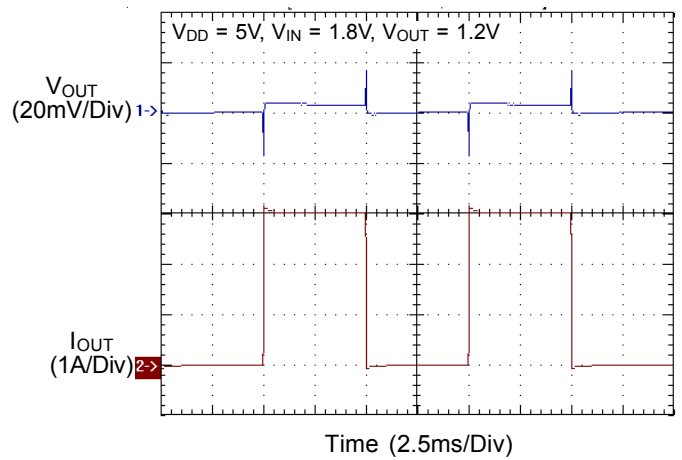

VIN Line Transient Response

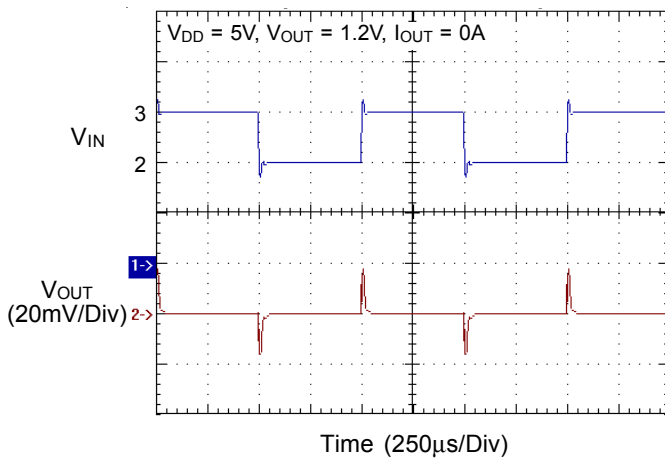

VIN Line Transient Response

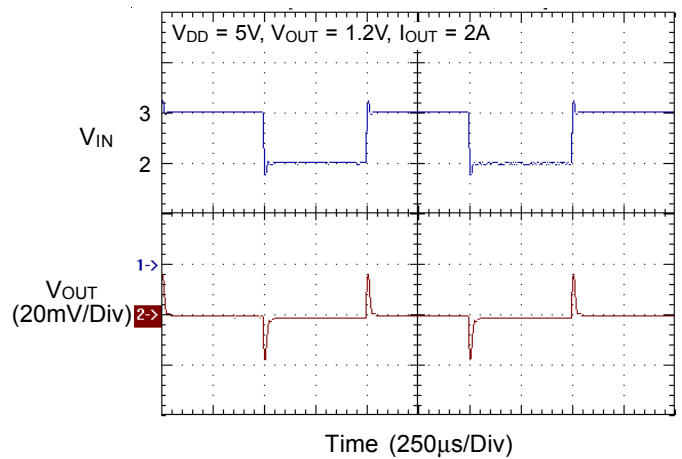

VDD Line Transient Response

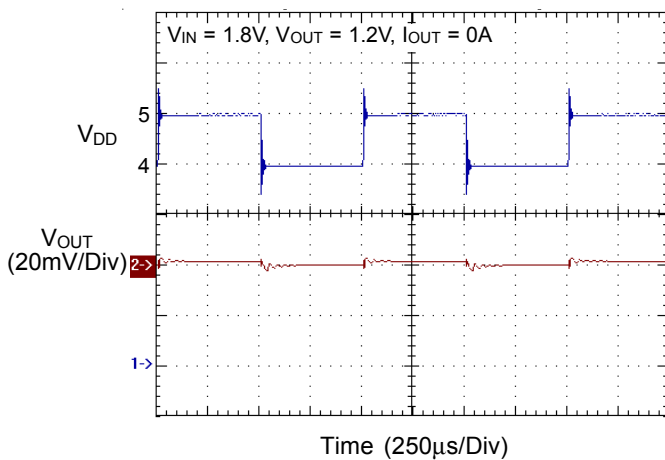

VDD Line Transient Response

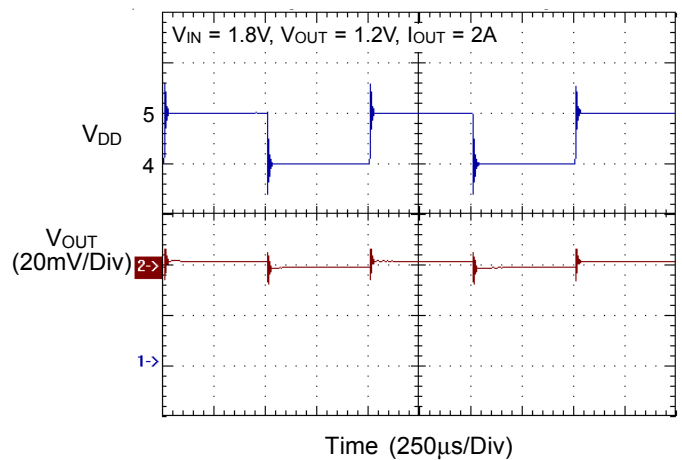

Dropout Voltage vs. Load Current

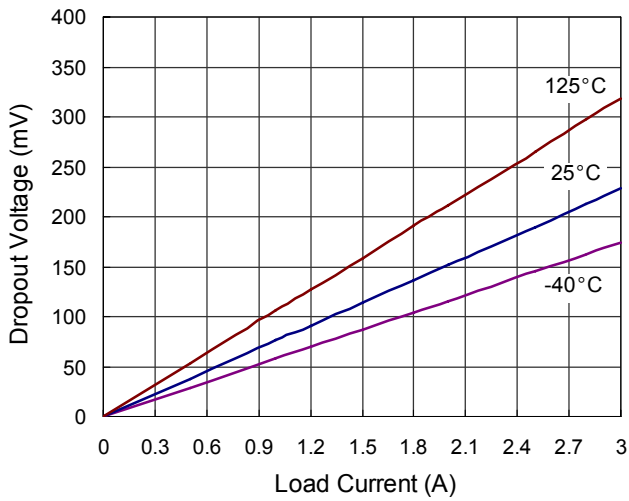

Start Up from Enable

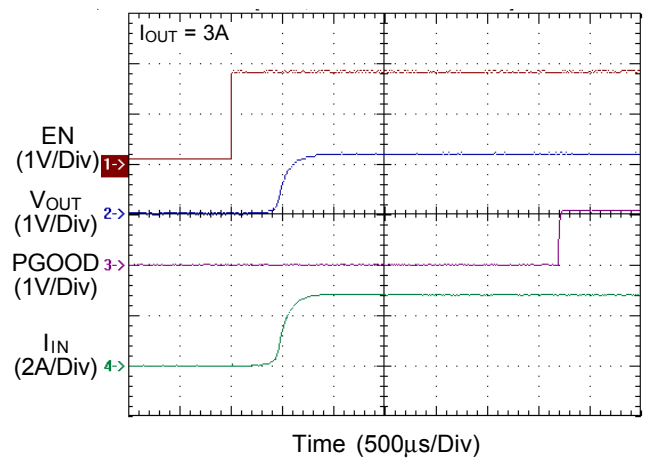

Start Up from V_{IN}

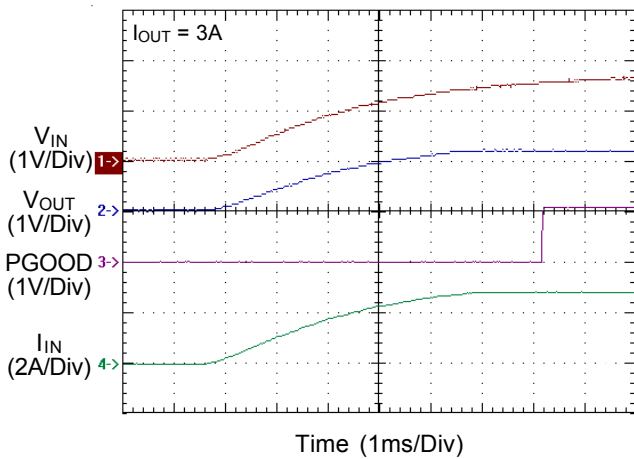

Start Up from V_{DD}

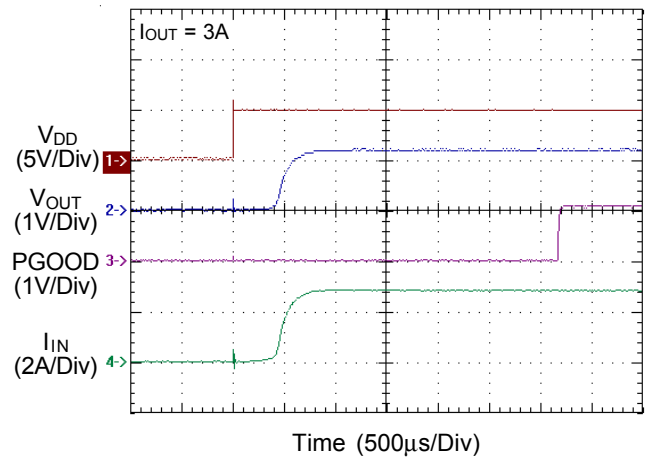

Short Circuit Protection

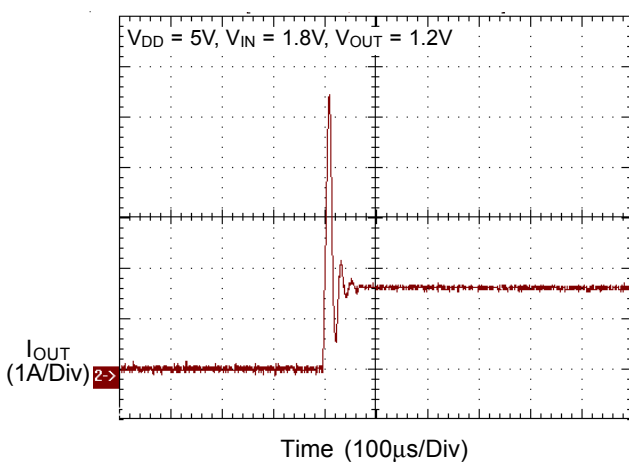

Short Circuit Current vs. Temperature

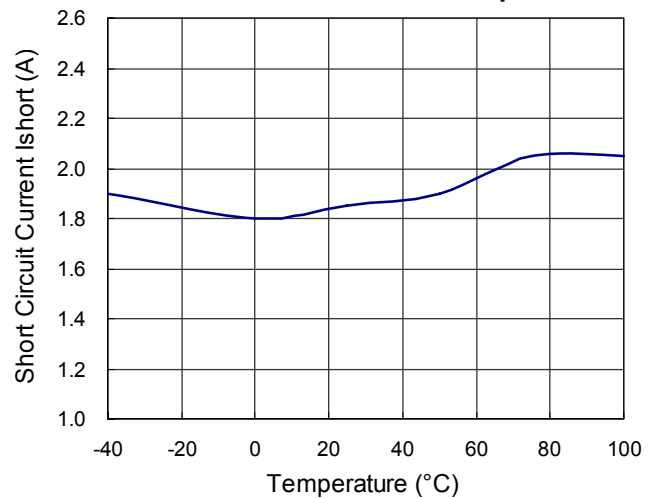

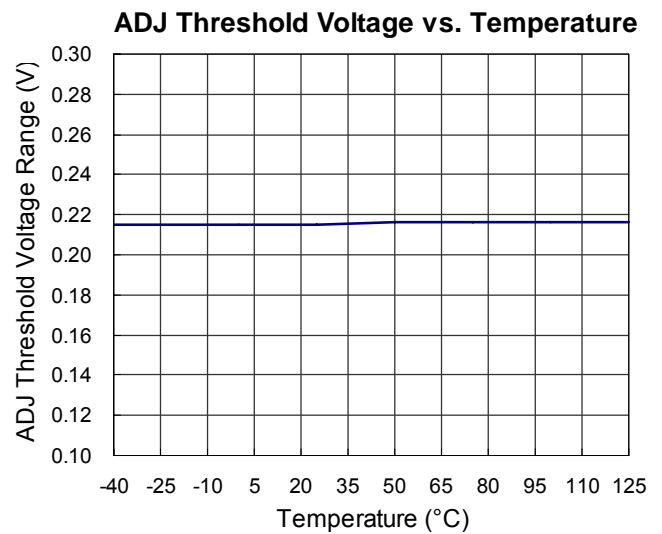
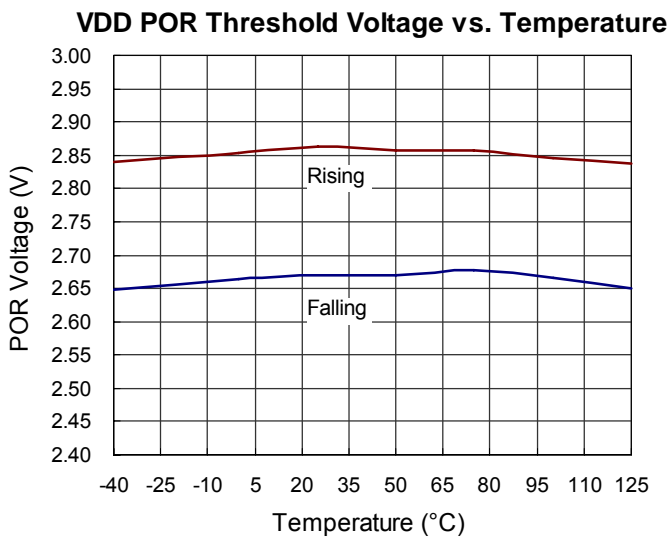
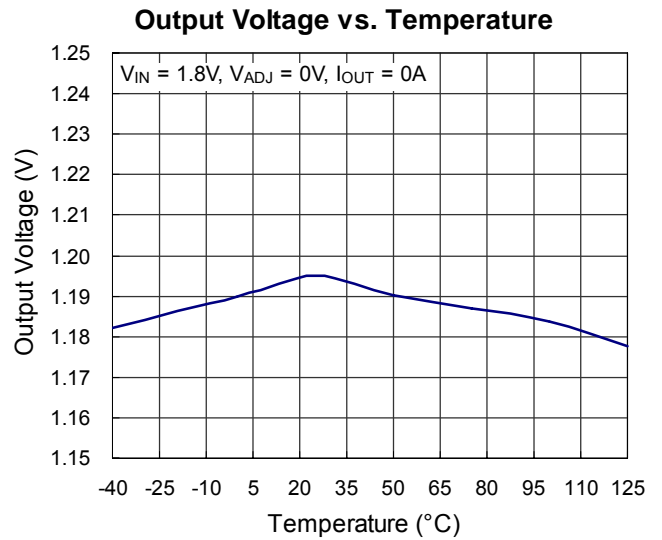
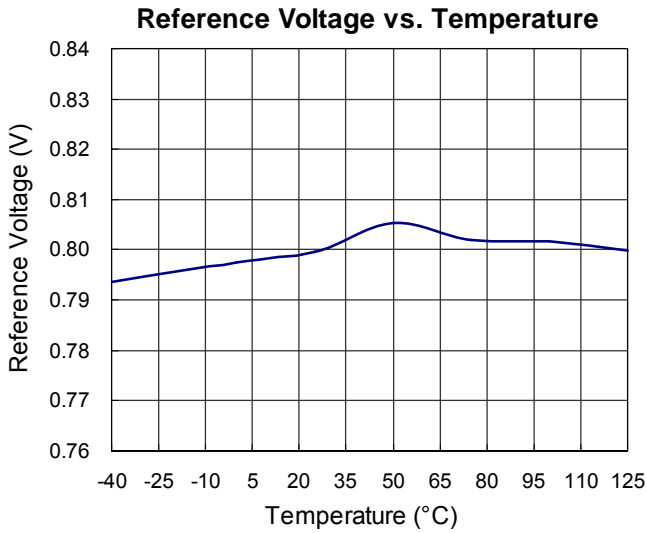
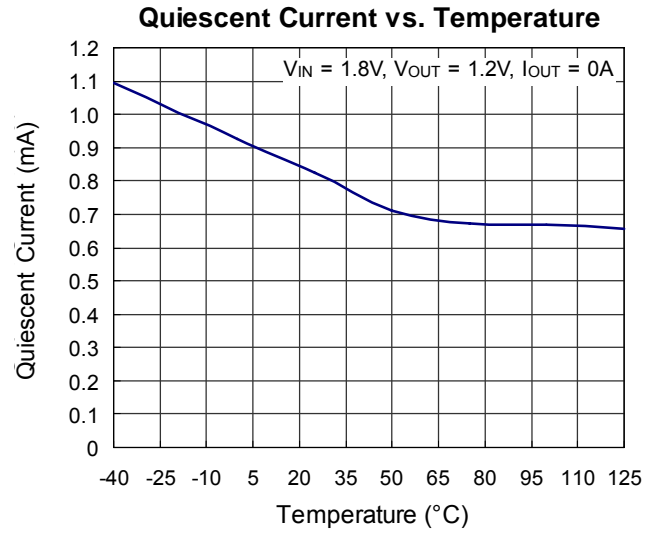
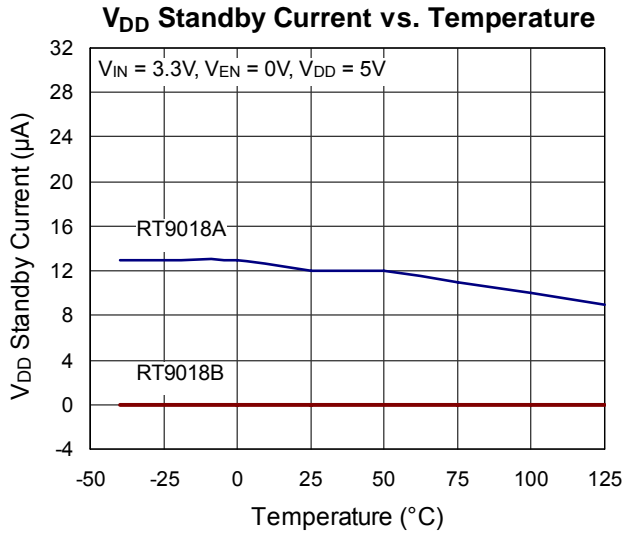

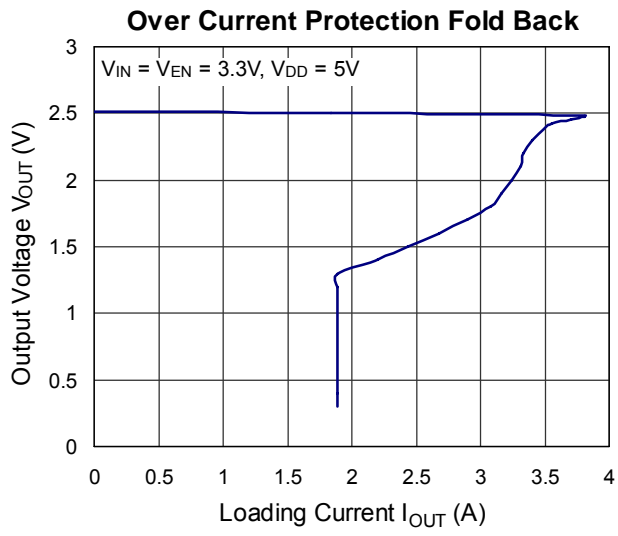

Application Information

Adjustable Mode Operation

The output voltage of RT9018A/B is adjustable from 0.8V to $(V_{IN} - V_{DROP})$ by external voltage divider resistors as shown in Typical Application Circuit (Figure 2). The value of resistors R1 and R2 should be more than 10kΩ to reduce the power loss. The V_{DD} must be greater than $(V_{OUT} + 1.5V)$.

Enable

The RT9018A/B goes into shutdown mode when the EN pin is in the logic low condition. During this condition, the pass transistor, error amplifier, and band gap are turned off, reducing the supply current to 10μA typical. The RT9018A/B goes into operation mode when the EN pin is in the logic high condition. If the EN pin is floating, NOTE that the RT9018A/B internal initial logic level. For RT9018A, the EN pin function pulls high level internally. So the regulator will be turn on when EN pin is floating. For RT9018B, the EN pin function pulls low level internally. So the regulator will be turn off when EN pin is floating.

Output Capacitor

The RT9018A/B is specifically designed to employ ceramic output capacitors as low as 10μF. The ceramic capacitors offer significant cost and space savings, along with high frequency noise filtering.

Input Capacitor

Good bypassing is recommended from input to ground to help improve AC performance. A 10μF input capacitor or greater located as close as possible to the IC is recommended.

Current Limit

The RT9018A/B contains an independent current limit and the short circuit current protection to prevent unexpected applications. The current limit monitors and controls the pass transistor's gate voltage, limiting the output current to higher than 4.5A typical. When the output voltage is less than 0.4V, the short circuit current protection starts the current fold back function and maintains the loading current 1.8A. The output can be shorted to ground indefinitely without damaging the part.

Power Good

The power good function is an open-drain output. Connects 100kΩ pull up resistor to VOUT to obtain an output voltage. The PGOOD pin will output high immediately after the output voltage arrives 90% of normal output voltage. The PGOOD pin will output high with typical 1.5ms delay time.

Thermal-Shutdown Protection

Thermal protection limits power dissipation to prevent IC over temperature in RT9018A/B. When the operation junction temperature exceeds 160°C, the over-temperature protection circuit starts the thermal shutdown function and turns the pass transistor off. The pass transistor turn on again after the junction temperature cools by 30°C. RT9018A/B lowers its OTP trip level from 160°C to 110°C when output short circuit occurs ($V_{OUT} < 0.4V$). It limits IC case temperature under 100°C and provides maximum safety to customer while output short circuit occurring.

Power Dissipation

For continuous operation, do not exceed absolute maximum operation junction temperature 125°C. The power dissipation definition in device is:

$$P_D = (V_{IN} - V_{OUT}) \times I_{OUT} + V_{IN} \times I_Q$$

The maximum power dissipation depends on the thermal resistance of IC package, PCB layout, the rate of surroundings airflow and temperature difference between junctions to ambient. The maximum power dissipation can be calculated by following formula:

$$P_{D(MAX)} = (T_{J(MAX)} - T_A) / \theta_{JA}$$

Where $T_{J(MAX)}$ is the maximum operation junction temperature 125°C, T_A is the ambient temperature and the θ_{JA} is the junction to ambient thermal resistance.

For recommended operating conditions specification of RT9018A/B, where $T_{J(MAX)}$ is the maximum junction temperature of the die (125°C) and T_A is the maximum ambient temperature. The junction to ambient thermal resistance for SOP-8 (Exposed Pad) package is 75°C/W on the standard JEDEC 51-7 (4 layers, 2S2P) thermal test board. The copper thickness is 2oz. The maximum power dissipation at $T_A = 25^\circ\text{C}$ can be calculated by

following formula:

$$P_{D(MAX)} = (125^{\circ}\text{C} - 25^{\circ}\text{C}) / (75^{\circ}\text{C/W}) = 1.33\text{W (SOP-8 Exposed Pad on the minimum layout)}$$

Layout Considerations

The thermal resistance θ_{JA} of SOP-8 (Exposed Pad) is determined by the package design and the PCB design. However, the package design had been designed. If possible, it's useful to increase thermal performance by the PCB design. The thermal resistance θ_{JA} can be decreased by adding a copper under the exposed pad of SOP-8 (Exposed Pad) package.

As shown in Figure 3, the amount of copper area to which the SOP-8 (Exposed Pad) is mounted affects thermal performance. When mounted to the standard SOP-8 (Exposed Pad) pad (Figure 3.a), θ_{JA} is 75°C/W . Adding copper area of pad under the SOP-8 (Exposed Pad) Figure 3.b) reduces the θ_{JA} to 64°C/W . Even further, increasing the copper area of pad to 70mm^2 (Figure 3.e) reduces the θ_{JA} to 49°C/W .

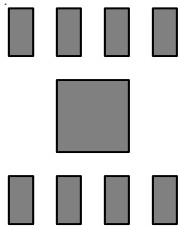

Figure 3 (a). Minimum Footprint, $\theta_{JA} = 75^{\circ}\text{C/W}$

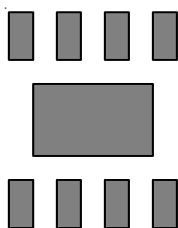

Figure 3 (b). Copper Area = 10mm^2 , $\theta_{JA} = 64^{\circ}\text{C/W}$

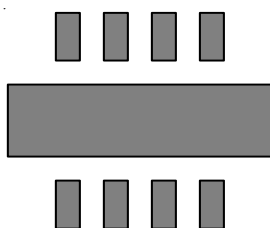

Figure 3 (c). Copper Area = 30mm^2 , $\theta_{JA} = 54^{\circ}\text{C/W}$

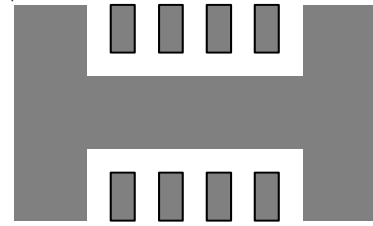

Figure 3 (d). Copper Area = 50mm^2 , $\theta_{JA} = 51^{\circ}\text{C/W}$

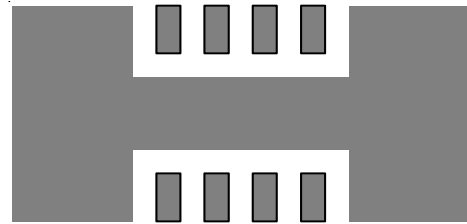

Figure 3 (e). Copper Area = 70mm^2 , $\theta_{JA} = 49^{\circ}\text{C/W}$

Figure 3. Thermal Resistance vs. Different Cooper Area Layout Design

The maximum power dissipation depends on operating ambient temperature for fixed $T_{J(MAX)}$ and thermal resistance θ_{JA} . For RT9018A/B packages, the Figure 4 of de-rating curves allows the designer to see the effect of rising ambient temperature on the maximum power allowed.

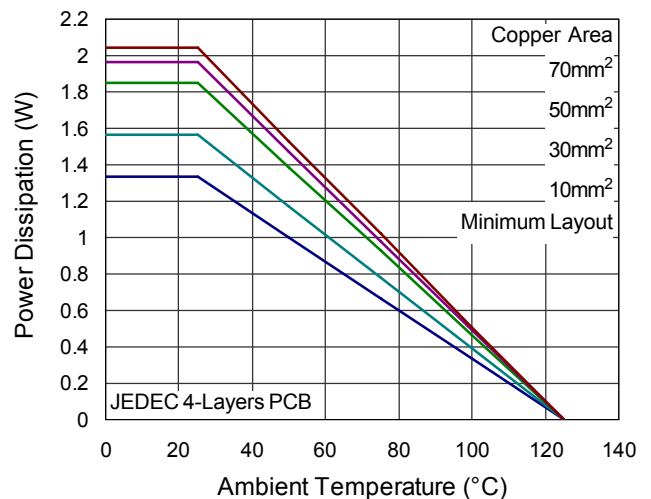
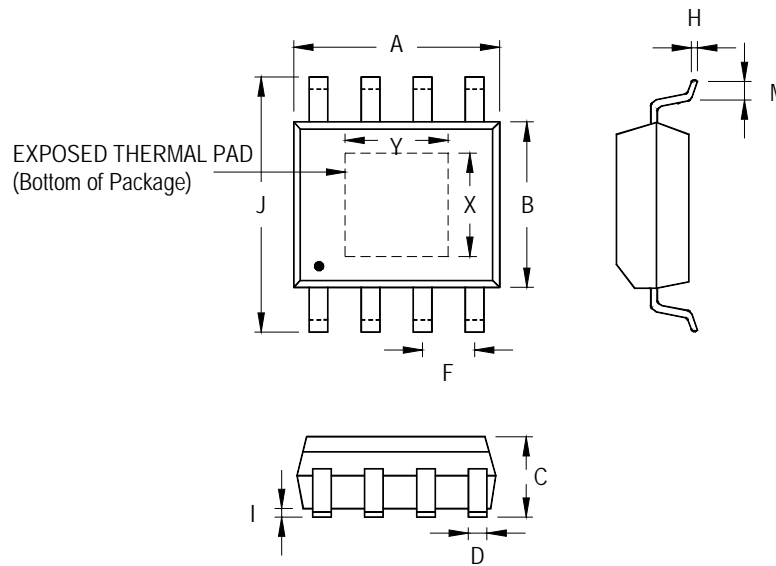

Figure 4. De-rating Curves

Outline Dimension



Symbol	Dimensions In Millimeters		Dimensions In Inches		
	Min	Max	Min	Max	
A	4.801	5.004	0.189	0.197	
B	3.810	4.000	0.150	0.157	
C	1.346	1.753	0.053	0.069	
D	0.330	0.510	0.013	0.020	
F	1.194	1.346	0.047	0.053	
H	0.170	0.254	0.007	0.010	
I	0.000	0.152	0.000	0.006	
J	5.791	6.200	0.228	0.244	
M	0.406	1.270	0.016	0.050	
Option 1	X	2.000	2.300	0.079	0.091
	Y	2.000	2.300	0.079	0.091
Option 2	X	2.100	2.500	0.083	0.098
	Y	3.000	3.500	0.118	0.138

8-Lead SOP (Exposed Pad) Plastic Package

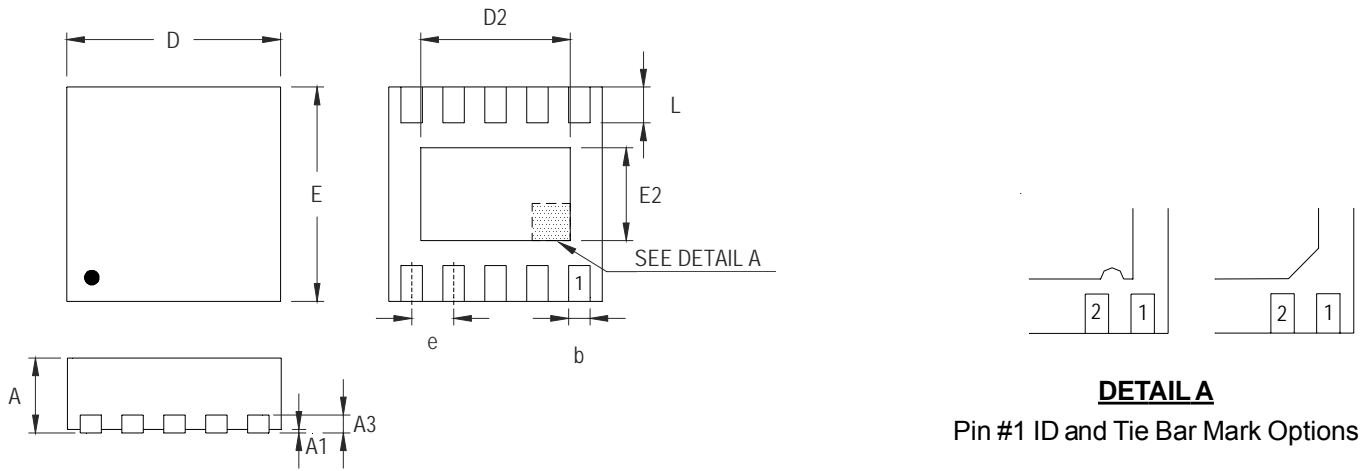

DETAIL A

Pin #1 ID and Tie Bar Mark Options

Note : The configuration of the Pin #1 identifier is optional, but must be located within the zone indicated.

Symbol	Dimensions In Millimeters		Dimensions In Inches	
	Min	Max	Min	Max
A	0.700	0.800	0.028	0.031
A1	0.000	0.050	0.000	0.002
A3	0.175	0.250	0.007	0.010
b	0.180	0.300	0.007	0.012
D	2.950	3.050	0.116	0.120
D2	2.300	2.650	0.091	0.104
E	2.950	3.050	0.116	0.120
E2	1.500	1.750	0.059	0.069
e	0.500		0.020	
L	0.350	0.450	0.014	0.018

W-Type 10L DFN 3x3 Package

Richtek Technology Corporation

Headquarter
 5F, No. 20, Taiyuen Street, Chupei City
 Hsinchu, Taiwan, R.O.C.
 Tel: (8863)5526789 Fax: (8863)5526611



Richtek Technology Corporation

Taipei Office (Marketing)
 8F, No. 137, Lane 235, Paochiao Road, Hsintien City
 Taipei County, Taiwan, R.O.C.
 Tel: (8862)89191466 Fax: (8862)89191465
 Email: marketing@richtek.com

Information that is provided by Richtek Technology Corporation is believed to be accurate and reliable. Richtek reserves the right to make any change in circuit design, specification or other related things if necessary without notice at any time. No third party intellectual property infringement of the applications should be guaranteed by users when integrating Richtek products into any application. No legal responsibility for any said applications is assumed by Richtek.

Looking for pricing, stock, or lifecycle information?

Click below to explore more details on WIN SOURCE:

-  [View RT9018A-10GSP on WIN SOURCE](#)
-  [Richtek USA Inc. Information](#)

Optimize Your Supply Chain with WIN SOURCE Solutions

-  Global Sourcing Solution
-  Obsolete Management
-  Cost Control Management
-  Shortage Management
-  Alternative Solution
-  Excess Inventory Management