



**THE DATASHEET OF  
CDRH125-150MC**



|                      |         |                                      |
|----------------------|---------|--------------------------------------|
| <b>SPECIFICATION</b> |         |                                      |
| SUMIDA TYPE          | CDRH125 | PART NO. REF. TO THE ATTACHED SHEET. |

1. DIMENSION (UNIT mm)

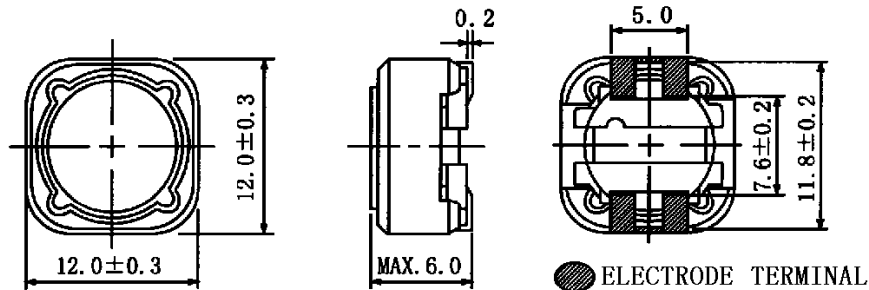

\* DIMENSION WITHOUT TOLERANCE ARE APPROX.

2. CONNECTION (BOTTOM)

3. STAMP (Ex.)

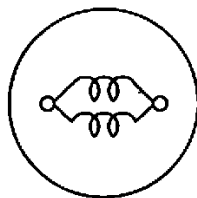

10  $\mu$ H ~ 47  $\mu$ H

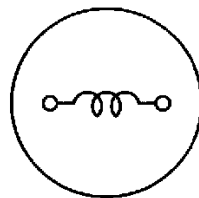

56  $\mu$ H ~ 1 mH

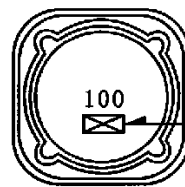

DATE CODE

DIRECTLY STAMP  
UNFIXED THE POSITION

4. NOTE

\* PLEASE DO NOT USE A WASHING AGENT.

\* ENCLOSING CONDITION OF COILS.

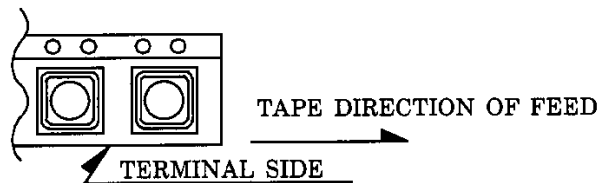

\* CARRIER TAPE PACKING SPECIFICATION IN DETAIL.(S-074-500)

\* RECOMMENDED REFLOW CONDITION TO BE ACCORDING TO S-074-5003.

|                    |             |             |             |      |              |
|--------------------|-------------|-------------|-------------|------|--------------|
| 22 nd JUN . , 1994 |             |             | SUMIDA CODE | 4735 |              |
| CH K.              | CH K.       | DR G.       |             |      | DRG. NO. 2/5 |
| O.SATO             | KOMA<br>ITA | SUZUKI<br>K |             |      | S-074-501    |

|                 |
|-----------------|
| TYPE<br>CDRH125 |
|-----------------|

GENERAL CHARACTERISTICS

1. STORAGE TEMPERATURE RANGE : -40°C~+85°C  $\Delta$
2. OPERATING TEMPERATURE : -25 ~ +80 °C (COIL CONTAIN HEAT)
3. EXTERNAL APPEARANCE : ON VISUAL INSPECTION, THE COIL HAS NO EXTERNAL DEFECTS.
4. ELECTRODE STRENGTH  $\Delta$  : AFTER SOLDERING, BETWEEN COPPER PLATE AND ELECTRODE OF COIL, PUSH IN THREE DIRECTIONS OF X, Y WITHSTANDING 4.9N(0.5kgf) FOR 10±2 SECONDS. ELECTRODE SHOULD NOT PEEL OFF. (REFER TO FIGURE AT RIGHT)
5. HEAT ENDURANCE TEST: REFER TO THE S-074-5002.
6. DIELECTRIC STRENGTH : NO APPARENT AT 100V D.C. FOR 1 MINUTE BETWEEN COIL-CORE.
7. INSULATING RESISTANCE : OVER 100 MΩ AT 100V D.C. BETWEEN COIL-CORE.
8. INDUCTANCE TEMPERATURE COEFFICIENT : ( 0 ~ 2000 )×10<sup>-6</sup>/°C (-25 ~ + 80 °C)
9. HUMIDITY TEST : INDUCTANCE DEVIATION WITHIN ± 5.0 %  
AFTER 96 HOURS IN 90 ~ 95 % RELATIVE HUMIDITY AT 40 ± 2 °C AND 1 HOUR DRYING UNDER NORMAL CONDITION.
10. VIBRATION TEST : INDUCTANCE DEVIATION WITHIN ± 3.0 % AFTER VIBRATION FOR 1 HOUR. IN EACH OF THREE ORIENTATIONS AT SWEEP VIBRATION (10~55~10 Hz) WITH 1.5 mm P-P AMPLITUDE.
11. SHOCK TEST : INDUCTANCE DEVIATION WITHIN ± 3.0 % AFTER DROP DOWN WITH 981m/s<sup>2</sup>(100G) SHOCK ATTITUDE UPON A RUBBER BLOCK METHOD SHOCK TESTING MACHINE, FOR 1 TIME, IN EACH OF THREE ORIENTATIONS.

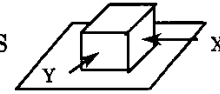

7 th DEC . , 1993

| CHK.   | CHK.   | DRG.       |
|--------|--------|------------|
| O.SATO | SUZUKI | MONMA<br>S |

|           |     |
|-----------|-----|
| DRG. NO.  | 3/5 |
| S-074-501 |     |

# SPECIFICATION

|      |         |
|------|---------|
| TYPE | CDRH125 |
|------|---------|

## ELECTRICAL CHARACTERISTICS

| NO. | PART NO.       | STAMP | INDUCTANCE<br>[WITHIN]<br>※1 | D.C.R.<br>(Ω) [MAX.]<br>(at 20°C)<br>(TYPICAL BALUE) | RATED<br>CURRENT<br>(A)<br>※2 | SUMIDA<br>CODE |
|-----|----------------|-------|------------------------------|--|-------------------------------|----------------|
| 01  | CDRH125-100 MC | 100   | 10 μH ± 20 %                 | 25 m (19 m)  | 4.00                          | -0001          |
| 02  | CDRH125-120 MC | 120   | 12 μH ± 20 %                 | 27 m (21 m)  | 3.50                          | -0012          |
| 03  | CDRH125-150 MC | 150   | 15 μH ± 20 %                 | 30 m (23 m)  | 3.30                          | -0023          |
| 04  | CDRH125-180 MC | 180   | 18 μH ± 20 %                 | 34 m (26 m)  | 3.00                          | -0034          |
| 05  | CDRH125-220 MC | 220   | 22 μH ± 20 %                 | 36 m (28 m)  | 2.80                          | -0045          |
| 06  | CDRH125-270 MC | 270   | 27 μH ± 20 %                 | 51 m (39 m)  | 2.30                          | -0056          |
| 07  | CDRH125-330 MC | 330   | 33 μH ± 20 %                 | 57 m (44 m)  | 2.10                          | -0067          |
| 08  | CDRH125-390 MC | 390   | 39 μH ± 20 %                 | 68 m (52 m)  | 2.00                          | -0078          |
| 09  | CDRH125-470 MC | 470   | 47 μH ± 20 %                 | 75 m (58 m)  | 1.80                          | -0089          |
| 10  | CDRH125-560 MC | 560   | 56 μH ± 20 %                 | 0.11 (84 m)  | 1.70                          | -0090          |
| 11  | CDRH125-680 MC | 680   | 68 μH ± 20 %                 | 0.12 (93 m)  | 1.50                          | -0101          |
| 12  | CDRH125-820 MC | 820   | 82 μH ± 20 %                 | 0.14 (0.11)  | 1.40                          | -0112          |
| 13  | CDRH125-101 MC | 101   | 100 μH ± 20 %                | 0.16 (0.12)  | 1.30                          | -0123          |
| 14  | CDRH125-121 MC | 121   | 120 μH ± 20 %                | 0.17 (0.13)  | 1.10                          | -0134          |
| 15  | CDRH125-151 MC | 151   | 150 μH ± 20 %                | 0.23 (0.18)  | 1.00                          | -0145          |
| 16  | CDRH125-181 MC | 181   | 180 μH ± 20 %                | 0.29 (0.22)  | 0.90                          | -0156          |
| 17  | CDRH125-221 MC | 221   | 220 μH ± 20 %                | 0.40 (0.31)  | 0.80                          | -0167          |
| 18  | CDRH125-271 MC | 271   | 270 μH ± 20 %                | 0.46 (0.35)  | 0.75                          | -0178          |
| 19  | CDRH125-331 MC | 331   | 330 μH ± 20 %                | 0.51 (0.39)  | 0.68                          | -0189          |
| 20  | CDRH125-391 MC | 391   | 390 μH ± 20 %                | 0.69 (0.53)  | 0.65                          | -0191          |
| 21  | CDRH125-471 MC | 471   | 470 μH ± 20 %                | 0.77 (0.59)  | 0.58                          | -0202          |
| 22  | CDRH125-561 MC | 561   | 560 μH ± 20 %                | 0.86 (0.66)  | 0.54                          | -0213          |
| 23  | CDRH125-681 MC | 681   | 680 μH ± 20 %                | 1.20 (0.92)  | 0.48                          | -0224          |
| 24  | CDRH125-821 MC | 821   | 820 μH ± 20 %                | 1.34 (1.03)  | 0.43                          | -0235          |
| 25  | CDRH125-102 MC | 102   | 1.0 mH ± 20 %                | 1.53 (1.18)  | 0.40                          | -0246          |

※1: MEASURED FREQUENCY L at 1 kHz

※2: THIS INDICATES THE VALUE OF CURRENT WHEN THE INDUCTANCE IS 75% MORE THAN IT'S NOMINAL VALUE AND TEMPERATURE RISING  $\Delta t = 40^\circ\text{C}$  LOWER AT D.C. SUPERPOSITION. ( $T_a = 20^\circ\text{C}$ )

|                   |        |            |             |      |
|-------------------|--------|------------|-------------|------|
| 7 th DEC . , 1993 |        |            | SUMIDA CODE | 4735 |
| C H K.            | C H K. | D R G.     | DEG NO. 4/5 |      |
| O.SATO            | SUZUKI | MONMA<br>S |             |      |
|                   |        |            | S-074-501   |      |



# SPECIFICATION

|      |         |
|------|---------|
| TYPE | CDRH125 |
|------|---------|

DIMENSION RECOMMENDED (mm)

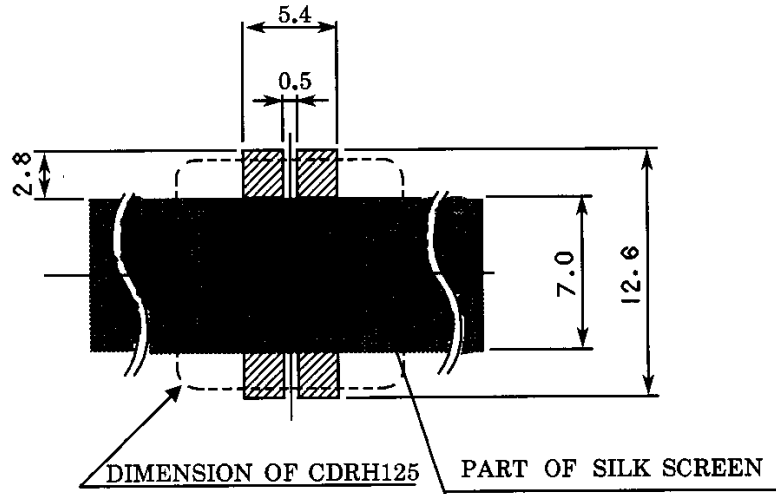

PLEASE COAT WITH SILK BETWEEN ELECTRODE.  $\triangle$

7 th DEC . , 1993

| C H K. | C H K. | D R G.     |
|--------|--------|------------|
| O.SATO | SUZUKI | MONMA<br>S |

|           |     |
|-----------|-----|
| DRG. NO.  | 5/5 |
| S-074-501 |     |

## Looking for pricing, stock, or lifecycle information?

Click below to explore more details on WIN SOURCE:

- ⊖ [View CDRH125-150MC on WIN SOURCE](#)
- ⊖ [Sumida America Components Inc. Information](#)

## Optimize Your Supply Chain with WIN SOURCE Solutions

- ✓ Global Sourcing Solution
- ✓ Obsolete Management
- ✓ Cost Control Management
- ✓ Shortage Management
- ✓ Alternative Solution
- ✓ Excess Inventory Management