



**THE DATASHEET OF
CDRH125-221MC**



SPECIFICATION		
SUMIDA TYPE	CDRH125	PART NO. REF. TO THE ATTACHED SHEET.

1. DIMENSION (UNIT mm)

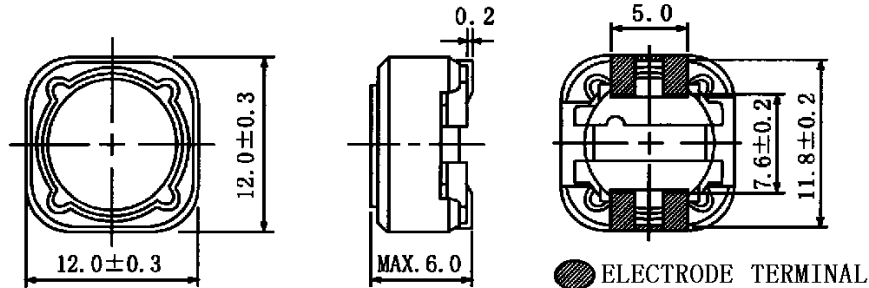

* DIMENSION WITHOUT TOLERANCE ARE APPROX.

2. CONNECTION (BOTTOM)

3. STAMP (Ex.)

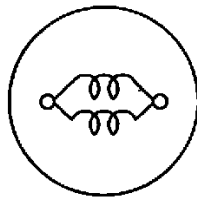

10 µH ~ 47 µH

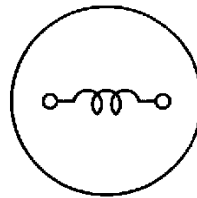

56 µH ~ 1 mH

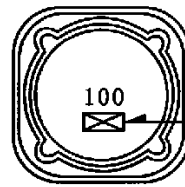

DATE CODE

DIRECTLY STAMP
UNFIXED THE POSITION

4. NOTE

* PLEASE DO NOT USE A WASHING AGENT.

* ENCLOSING CONDITION OF COILS.

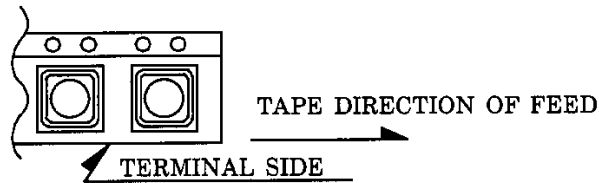

* CARRIER TAPE PACKING SPECIFICATION IN DETAIL.(S-074-500)

* RECOMMENDED REFLOW CONDITION TO BE ACCORDING TO S-074-5003.

22 nd JUN . , 1994			SUMIDA CODE	4735	
CHK.	CHK.	DRG.			DRG. NO. 2/5
O.SATO	KOMA ITA	SUZUKI K			S-074-501

TYPE CDRH125

GENERAL CHARACTERISTICS

1. STORAGE TEMPERATURE RANGE : -40°C~+85°C Δ
2. OPERATING TEMPERATURE : -25 ~ +80 °C (COIL CONTAIN HEAT)
3. EXTERNAL APPEARANCE : ON VISUAL INSPECTION, THE COIL HAS NO EXTERNAL DEFECTS.
4. ELECTRODE STRENGTH Δ : AFTER SOLDERING, BETWEEN COPPER PLATE AND ELECTRODE OF COIL, PUSH IN THREE DIRECTIONS OF X, Y WITHSTANDING 4.9N(0.5kgf) FOR 10±2 SECONDS. ELECTRODE SHOULD NOT PEEL OFF. (REFER TO FIGURE AT RIGHT)
5. HEAT ENDURANCE TEST: REFER TO THE S-074-5002.
6. DIELECTRIC STRENGTH : NO APPARENT AT 100V D.C. FOR 1 MINUTE BETWEEN COIL-CORE.
7. INSULATING RESISTANCE : OVER 100 MΩ AT 100V D.C. BETWEEN COIL-CORE.
8. INDUCTANCE TEMPERATURE COEFFICIENT : (0 ~ 2000)×10⁻⁶/°C (-25 ~ + 80 °C)
9. HUMIDITY TEST : INDUCTANCE DEVIATION WITHIN ± 5.0 %
AFTER 96 HOURS IN 90 ~ 95 % RELATIVE HUMIDITY AT 40 ± 2 °C AND 1 HOUR DRYING UNDER NORMAL CONDITION.
10. VIBRATION TEST : INDUCTANCE DEVIATION WITHIN ± 3.0 % AFTER VIBRATION FOR 1 HOUR. IN EACH OF THREE ORIENTATIONS AT SWEEP VIBRATION (10~55~10 Hz) WITH 1.5 mm P-P AMPLITUDE.
11. SHOCK TEST : INDUCTANCE DEVIATION WITHIN ± 3.0 % AFTER DROP DOWN WITH 981m/s²(100G) SHOCK ATTITUDE UPON A RUBBER BLOCK METHOD SHOCK TESTING MACHINE, FOR 1 TIME, IN EACH OF THREE ORIENTATIONS.

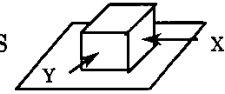

7 th DEC . , 1993

CHK.	CHK.	DRG.
O.SATO	SUZUKI	MONMA S

DRG. NO.	3/5
S-074-501	

SPECIFICATION

TYPE	CDRH125
------	---------

ELECTRICAL CHARACTERISTICS

NO.	PART NO.	STAMP	INDUCTANCE [WITHIN] ※1	D.C.R. (Ω) [MAX.] (at 20°C) (TYPICAL BALUE)	RATED CURRENT (A) ※2	SUMIDA CODE
01	CDRH125-100 MC	100	10 μ H \pm 20 %	25 m (19 m)	4.00	-0001
02	CDRH125-120 MC	120	12 μ H \pm 20 %	27 m (21 m)	3.50	-0012
03	CDRH125-150 MC	150	15 μ H \pm 20 %	30 m (23 m)	3.30	-0023
04	CDRH125-180 MC	180	18 μ H \pm 20 %	34 m (26 m)	3.00	-0034
05	CDRH125-220 MC	220	22 μ H \pm 20 %	36 m (28 m)	2.80	-0045
06	CDRH125-270 MC	270	27 μ H \pm 20 %	51 m (39 m)	2.30	-0056
07	CDRH125-330 MC	330	33 μ H \pm 20 %	57 m (44 m)	2.10	-0067
08	CDRH125-390 MC	390	39 μ H \pm 20 %	68 m (52 m)	2.00	-0078
09	CDRH125-470 MC	470	47 μ H \pm 20 %	75 m (58 m)	1.80	-0089
10	CDRH125-560 MC	560	56 μ H \pm 20 %	0.11 (84 m)	1.70	-0090
11	CDRH125-680 MC	680	68 μ H \pm 20 %	0.12 (93 m)	1.50	-0101
12	CDRH125-820 MC	820	82 μ H \pm 20 %	0.14 (0.11)	1.40	-0112
13	CDRH125-101 MC	101	100 μ H \pm 20 %	0.16 (0.12)	1.30	-0123
14	CDRH125-121 MC	121	120 μ H \pm 20 %	0.17 (0.13)	1.10	-0134
15	CDRH125-151 MC	151	150 μ H \pm 20 %	0.23 (0.18)	1.00	-0145
16	CDRH125-181 MC	181	180 μ H \pm 20 %	0.29 (0.22)	0.90	-0156
17	CDRH125-221 MC	221	220 μ H \pm 20 %	0.40 (0.31)	0.80	-0167
18	CDRH125-271 MC	271	270 μ H \pm 20 %	0.46 (0.35)	0.75	-0178
19	CDRH125-331 MC	331	330 μ H \pm 20 %	0.51 (0.39)	0.68	-0189
20	CDRH125-391 MC	391	390 μ H \pm 20 %	0.69 (0.53)	0.65	-0191
21	CDRH125-471 MC	471	470 μ H \pm 20 %	0.77 (0.59)	0.58	-0202
22	CDRH125-561 MC	561	560 μ H \pm 20 %	0.86 (0.66)	0.54	-0213
23	CDRH125-681 MC	681	680 μ H \pm 20 %	1.20 (0.92)	0.48	-0224
24	CDRH125-821 MC	821	820 μ H \pm 20 %	1.34 (1.03)	0.43	-0235
25	CDRH125-102 MC	102	1.0 mH \pm 20 %	1.53 (1.18)	0.40	-0246

※1: MEASURED FREQUENCY L at 1 kHz

※2: THIS INDICATES THE VALUE OF CURRENT WHEN THE INDUCTANCE IS 75% MORE THAN IT'S NOMINAL VALUE AND TEMPERATURE RISING $\Delta t = 40^\circ\text{C}$ LOWER AT D.C. SUPERPOSITION. ($T_a = 20^\circ\text{C}$)

7 th DEC . , 1993			SUMIDA CODE	4735
C H K.	C H K.	D R G.	DEG NO. 4/5	
O.SATO	SUZUKI	MONMA S		
			S-074-501	



SPECIFICATION

TYPE	CDRH125
------	---------

DIMENSION RECOMMENDED (mm)

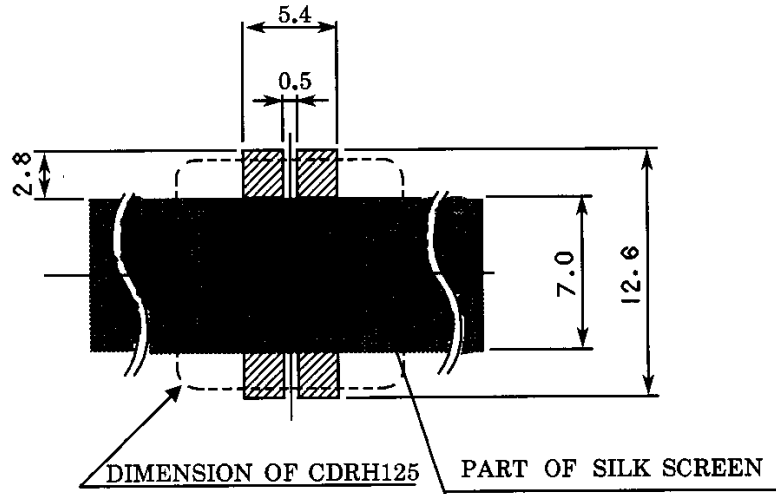

PLEASE COAT WITH SILK BETWEEN ELECTRODE. \triangle

7 th DEC . , 1993

C H K.	C H K.	D R G.
O.SATO	SUZUKI	MONMA S

DRG. NO.	5/5
S-074-501	

Looking for pricing, stock, or lifecycle information?

Click below to explore more details on WIN SOURCE:

- ⊖ [View CDRH125-221MC on WIN SOURCE](#)
- ⊖ [Sumida America Components Inc. Information](#)

Optimize Your Supply Chain with WIN SOURCE Solutions

- ✓ Global Sourcing Solution
- ✓ Obsolete Management
- ✓ Cost Control Management
- ✓ Shortage Management
- ✓ Alternative Solution
- ✓ Excess Inventory Management