



**THE DATASHEET OF  
CDRH127C/ANP-470MC**



# SMD Power Inductor CDRH127C/A



## Description

- Ferrite drum core construction.
- Magnetically shielded.
- L × W × H: 12.9 × 12.9 × 8.0 mm Max.
- Product weight: 4.4 g(Ref.)
- Moisture Sensitivity Level: 1
- RoHS compliance.

## Environmental Data

- Operating temperature range: -40°C~+125°C (including coil's self temperature rise).
- Storage temperature range: -40°C~+85°C
- Solder reflow temperature: 260 °C peak.

## Packaging

- Carrier tape and reel packaging.
- 13.0" diameter reel
- 500pcs per reel

## Applications

- Automotive and other high temperature, high reliability application.

## Dimension - [mm]

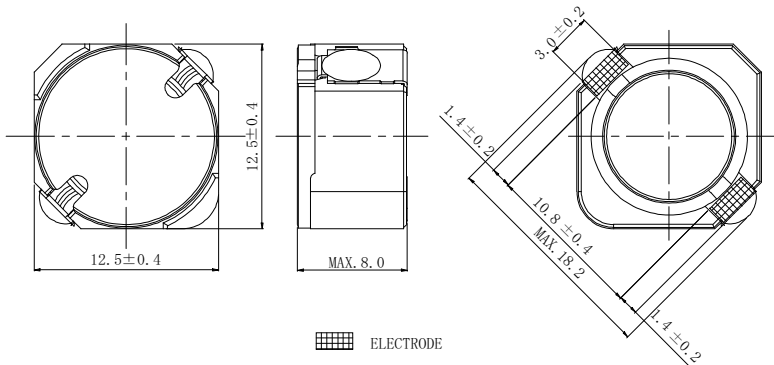

## Land pattern and Schematics - [mm]

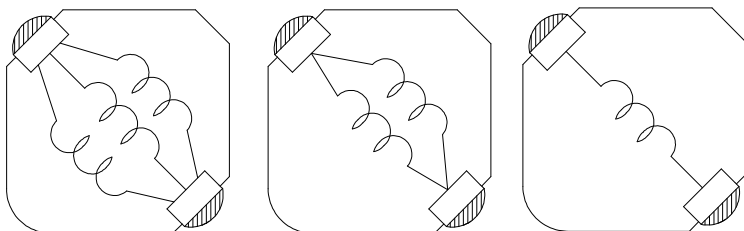
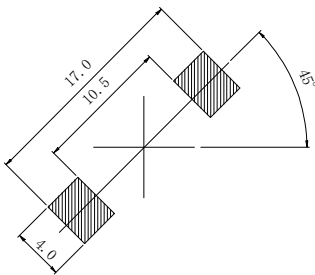

(10 μH ~ 15 μH) (18 μH ~ 100 μH) (120 μH ~ 470 μH)

# SMD Power Inductor CDRH127C/A

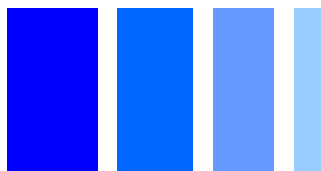

## Electrical Characteristics

Part NO.	Stamp	Inductance [ $\mu$ H] [Within] ※1	D.C.R. (m $\Omega$ ) [MAX.] (Typ.) (at 20°C)	Rated current (at 125°C) (A) ※2
CDRH127C/ANP-100MC	100	10 $\mu$ H $\pm$ 20%	16.8(13.4)	4.6
CDRH127C/ANP-120MC	120	12 $\mu$ H $\pm$ 20%	18.7(14.9)	4.3
CDRH127C/ANP-150MC	150	15 $\mu$ H $\pm$ 20%	20.5(16.4)	4.1
CDRH127C/ANP-180MC	180	18 $\mu$ H $\pm$ 20%	25.4(20.3)	3.5
CDRH127C/ANP-220MC	220	22 $\mu$ H $\pm$ 20%	30.0(23.8)	3.3
CDRH127C/ANP-270MC	270	27 $\mu$ H $\pm$ 20%	32.0(25.6)	3.2
CDRH127C/ANP-330MC	330	33 $\mu$ H $\pm$ 20%	46.0(36.8)	2.5
CDRH127C/ANP-390MC	390	39 $\mu$ H $\pm$ 20%	57.4(45.9)	2.2
CDRH127C/ANP-470MC	470	47 $\mu$ H $\pm$ 20%	64.7(51.7)	2.1
CDRH127C/ANP-560MC	560	56 $\mu$ H $\pm$ 20%	80.3(64.2)	1.9
CDRH127C/ANP-680MC	680	68 $\mu$ H $\pm$ 20%	88.2(70.5)	1.8
CDRH127C/ANP-820MC	820	82 $\mu$ H $\pm$ 20%	123.0(98.4)	1.55
CDRH127C/ANP-101MC	101	100 $\mu$ H $\pm$ 20%	139.4(111.5)	1.50
CDRH127C/ANP-121MC	121	120 $\mu$ H $\pm$ 20%	174.9(139.9)	1.35
CDRH127C/ANP-151MC	151	150 $\mu$ H $\pm$ 20%	200.6(160.5)	1.30
CDRH127C/ANP-181MC	181	180 $\mu$ H $\pm$ 20%	218.9(175.1)	1.25
CDRH127C/ANP-221MC	221	220 $\mu$ H $\pm$ 20%	315.3(252.2)	1.00
CDRH127C/ANP-271MC	271	270 $\mu$ H $\pm$ 20%	354.4(283.5)	0.95
CDRH127C/ANP-331MC	331	330 $\mu$ H $\pm$ 20%	501.5(401.2)	0.80
CDRH127C/ANP-391MC	391	390 $\mu$ H $\pm$ 20%	554.4(443.5)	0.75
CDRH127C/ANP-471MC	471	470 $\mu$ H $\pm$ 20%	620.1(496.1)	0.70

※1. Inductance measuring condition: at 100 kHz.

※2. Rated current: The DC current at which the inductance decreases to 65% of its nominal value or when  $\Delta t=30^{\circ}\text{C}$ , whichever is lower .

# SMD Power Inductor CDRH127C/A



## Saturation Current & Temperature Rise Graph

— L (20°C) — L (125°C) —  $\Delta T$

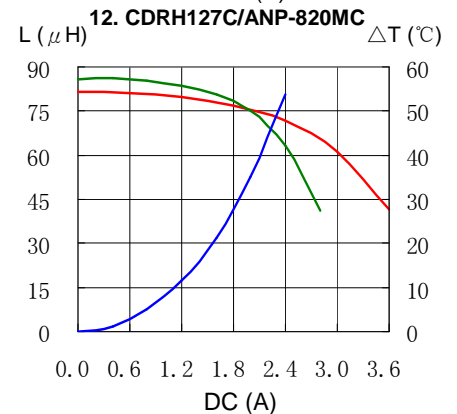
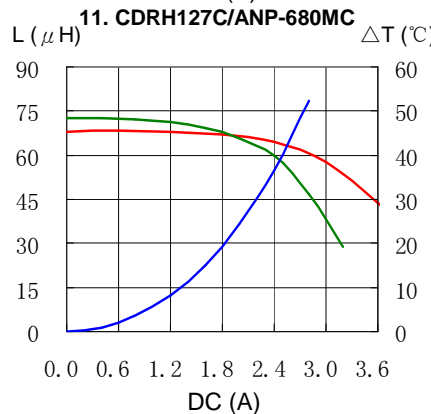
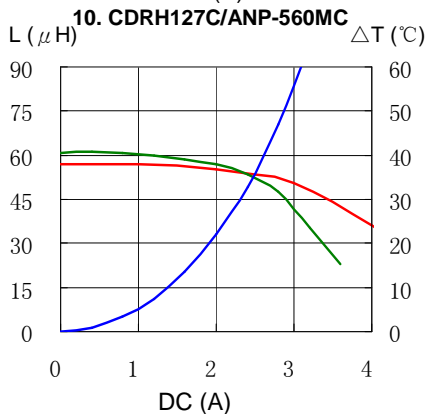
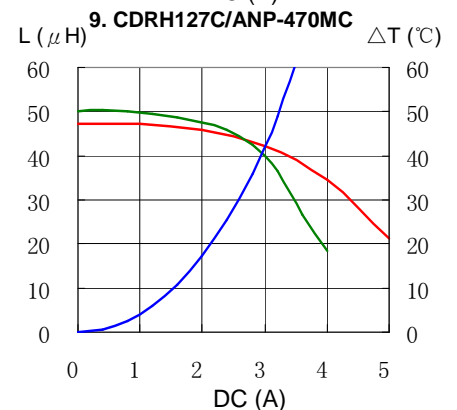
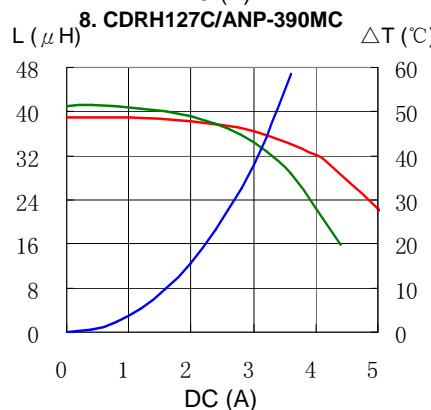
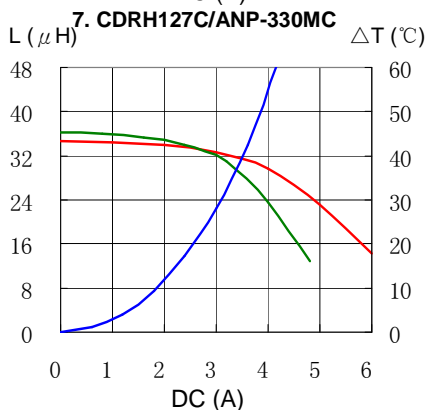
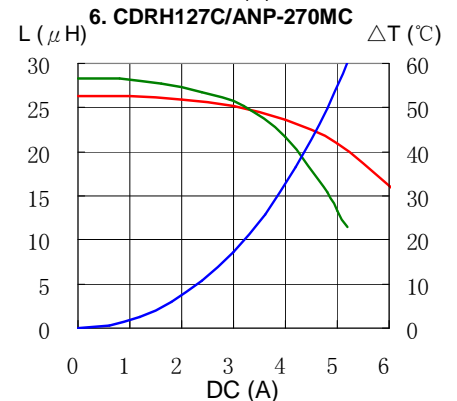
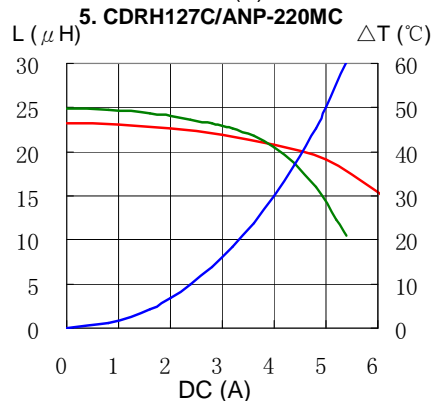
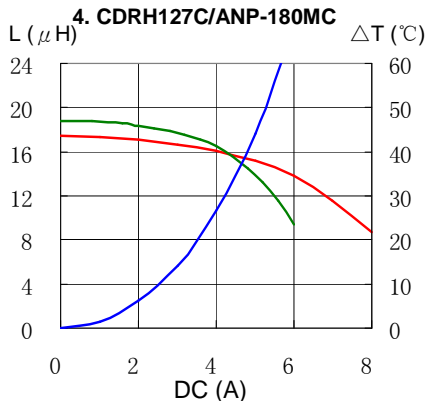
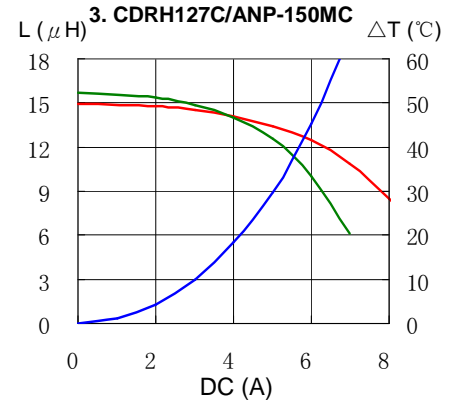
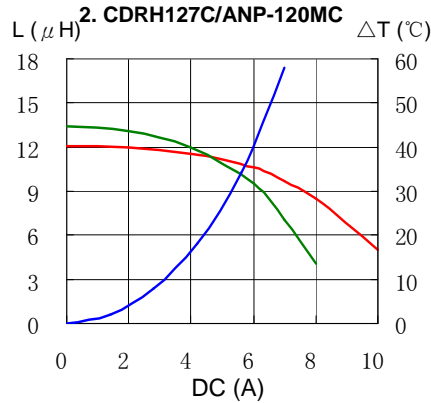
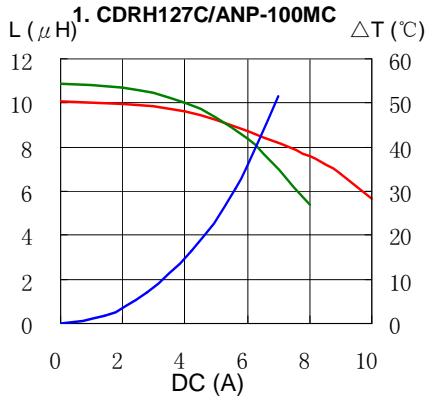

# SMD Power Inductor CDRH127C/A



## Saturation Current & Temperature Rise Graph

— L (20°C) — L (125°C) —  $\Delta T$

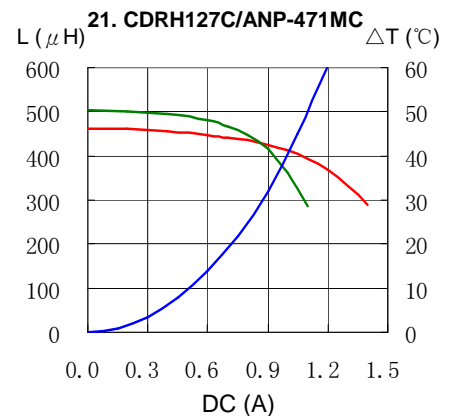
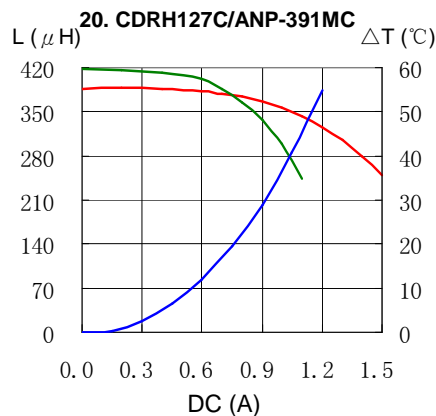
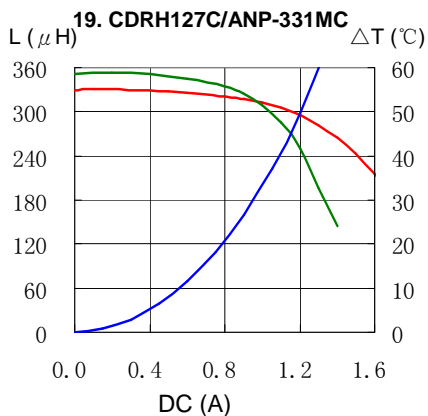
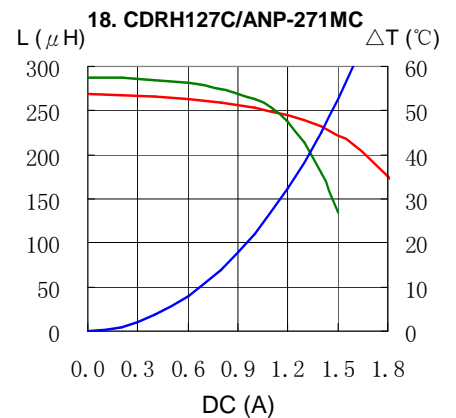
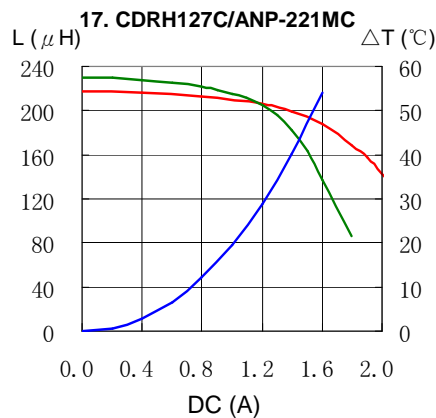
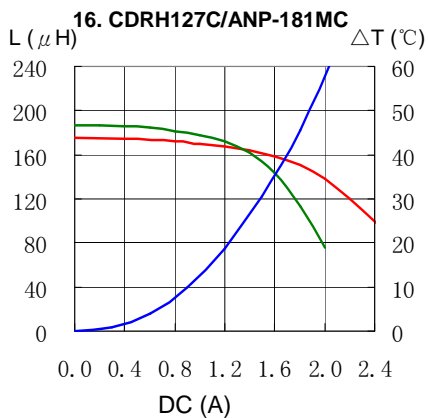
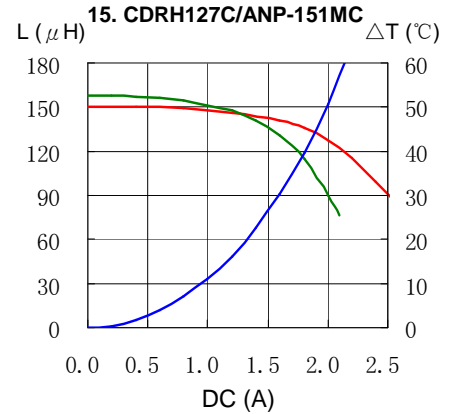
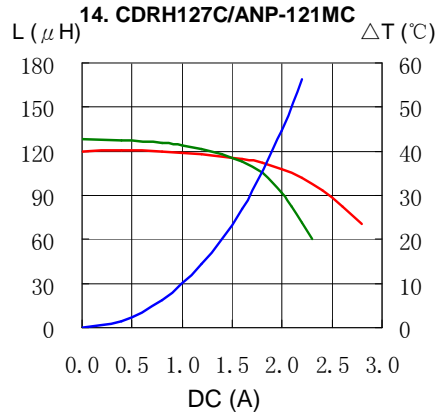
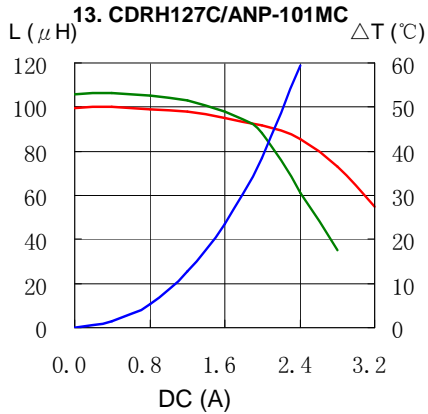

# SMD Power Inductor CDRH127C/A



## Solder Reflow Condition

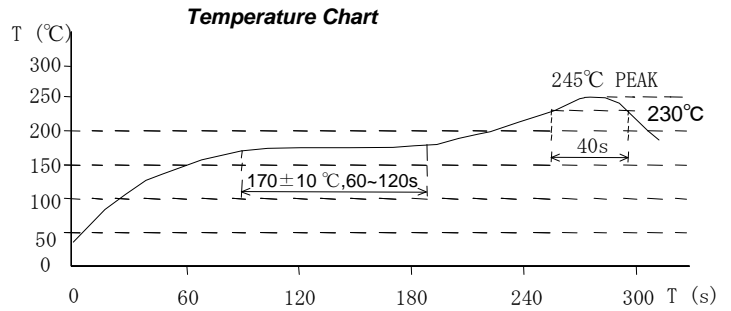
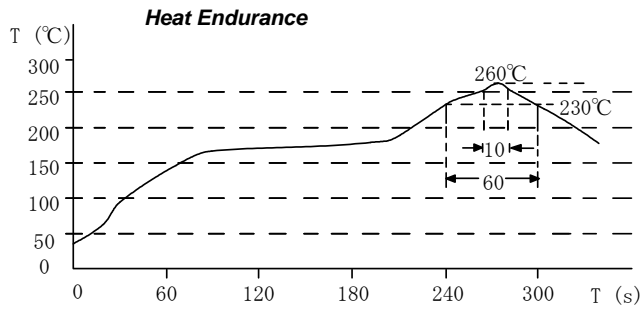

Please refer to the sales offices on our website - <http://www.sumida.com>

**Hong Kong**  
Tel.+852-2880-6781  
FAX.+852-2565-9600  
[sales@hk.sumida.com](mailto:sales@hk.sumida.com)

**Saitama(Japan)**  
Tel.+81-48-691-7300  
FAX.+81-48-691-7340  
[sales@jp.sumida.com](mailto:sales@jp.sumida.com)

**Chicago**  
Tel.+1-847-545-6700  
FAX. +1-847-545-6720  
[sales@us.sumida.com](mailto:sales@us.sumida.com)

**Shanghai**  
Tel.+86-21-5836-3299  
FAX.+86-21-5836-3266  
[shanghai.sales@cn.sumida.com](mailto:shanghai.sales@cn.sumida.com)

**Seoul**  
Tel.+82-2-6237-0777  
FAX.+82-2-6237-0778  
[sales@kr.sumida.com](mailto:sales@kr.sumida.com)

**Oberzell**  
Tel.+49-8591-937-0  
FAX. +49-8591-937-103  
[contact@eu.sumida.com](mailto:contact@eu.sumida.com)

**Shenzhen**  
Tel.+86-755-8291-0228  
FAX.+86-755-8291-0338  
[shenzhen.sales@cn.sumida.com](mailto:shenzhen.sales@cn.sumida.com)

**Singapore**  
Tel.+65-6296-3388  
FAX.+65-6841-4426  
[sales@sg.sumida.com](mailto:sales@sg.sumida.com)

**Neumarkt**  
Tel.+49-9181-4509-110  
FAX. +49-9181-4509-310  
[infocomp@eu.sumida.com](mailto:infocomp@eu.sumida.com)

**Taipei**  
Tel.+886-2-8751-2737  
FAX.+886-2-8751-2738  
[sales@tw.sumida.com](mailto:sales@tw.sumida.com)

**San Jose**  
Tel.+1-408-321-9660  
FAX.+1-408-321-9308  
[sales@us.sumida.com](mailto:sales@us.sumida.com)

## Looking for pricing, stock, or lifecycle information?

Click below to explore more details on WIN SOURCE:

- ⊖ [View CDRH127C/ANP-470MC on WIN SOURCE](#)
- ⊖ [Sumida America Components Inc. Information](#)

## Optimize Your Supply Chain with WIN SOURCE Solutions

- ✓ Global Sourcing Solution
- ✓ Obsolete Management
- ✓ Cost Control Management
- ✓ Shortage Management
- ✓ Alternative Solution
- ✓ Excess Inventory Management