



**THE DATASHEET OF
CDRH2D18/LDNP-4R7NC**



SMD Power Inductor CDRH2D18/LD



Halogen Free

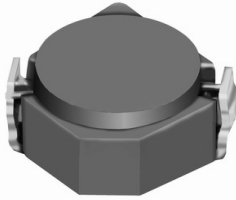

Description

- Ferrite drum core construction.
- Magnetically shielded.
- L × W × H: 3.2 × 3.2 × 2.0 mm Max.
- Product weight: 65mg(Ref.)
- Moisture Sensitivity Level: 1
- RoHS compliance.
- Halogen Free available.

Environmental Data

- Operating temperature range: -40°C~+105°C (including coil's self temperature rise)
- Storage temperature range: -40°C~+105°C
- Solder reflow temperature: 260 °C peak.

Packaging

- Carrier tape and reel packaging
- 7.0" diameter reel
- 1000pcs per reel

Applications

- Ideally used in Mobilephone, PDA, MP3, DSC/DVC, Portable DVD, etc as DC-DC converter inductors.

Dimension - [mm]

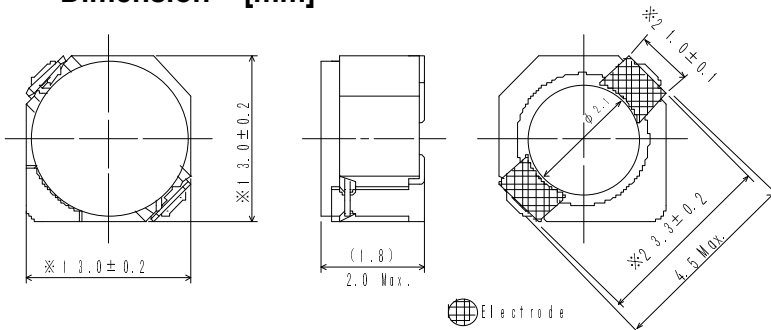

Electrode

Land pattern and Schematics - [mm]

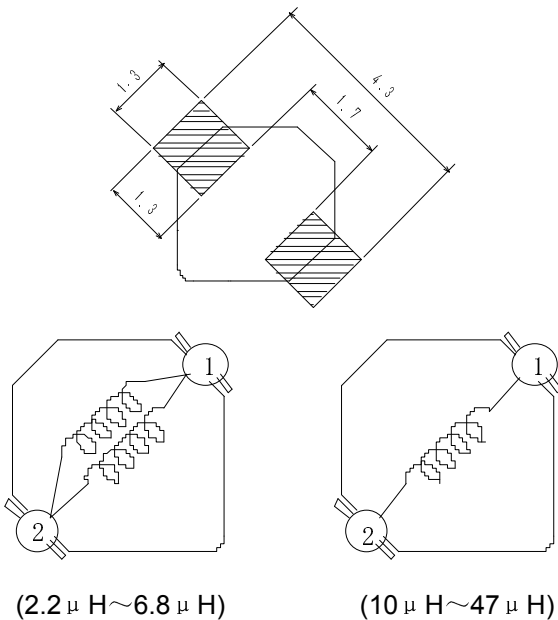

SMD Power Inductor CDRH2D18/LD



Electrical Characteristics

Part Name	Stamp	Inductance (μ H) [within] ※1	D.C.R. (m Ω) Max. (Typ.) (at 20°C)	Saturation Current (A) ※2		Temperature Rise Current (A) ※3
				at 20°C	at 100°C	
CDRH2D18/LDNP-2R2NC	C	2.2 \pm 30%	41(33)	0.85	0.67	2.30
CDRH2D18/LDNP-3R3NC	E	3.3 \pm 30%	54(43)	0.75	0.55	2.10
CDRH2D18/LDNP-4R7NC	G	4.7 \pm 30%	78(62)	0.63	0.47	1.65
CDRH2D18/LDNP-6R8NC	I	6.8 \pm 30%	106(85)	0.52	0.40	1.32
CDRH2D18/LDNP-100NC	K	10 \pm 30%	180(145)	0.43	0.33	1.00
CDRH2D18/LDNP-150NC	M	15 \pm 30%	220(175)	0.35	0.28	0.80
CDRH2D18/LDNP-220NC	O	22 \pm 30%	320(255)	0.30	0.22	0.68
CDRH2D18/LDNP-330NC	Q	33 \pm 30%	460(370)	0.24	0.18	0.56
CDRH2D18/LDNP-470NC	S	47 \pm 30%	660(530)	0.20	0.15	0.48

※1. Inductance measuring condition: at 100kHz.

※2. Saturation current: The value of D.C. current when the inductance decreases to 65% of its nominal value.

※3. Temperature rise current: The value of D.C. current when the temperature rise is $\Delta t=40^{\circ}\text{C}$ ($T_a=20^{\circ}\text{C}$).

SMD Power Inductor CDRH2D18/LD

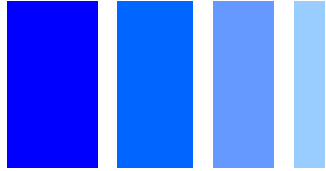

Saturation Current & Temperature Rise Graph

— L (20°C) — L (100°C) — ΔT

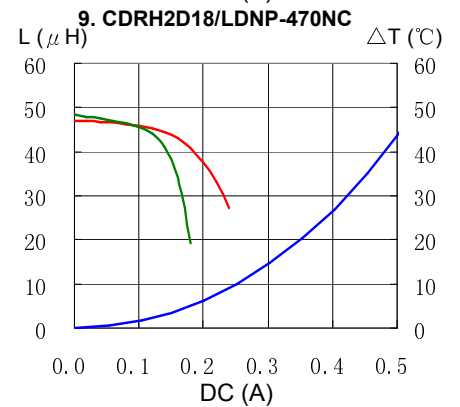
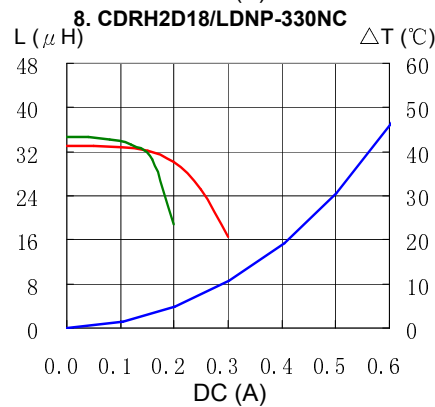
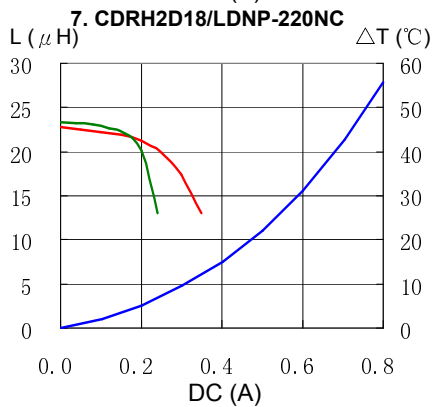
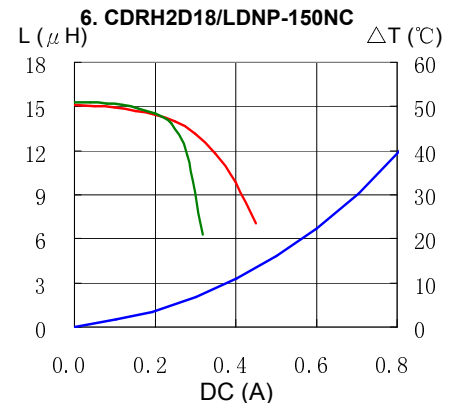
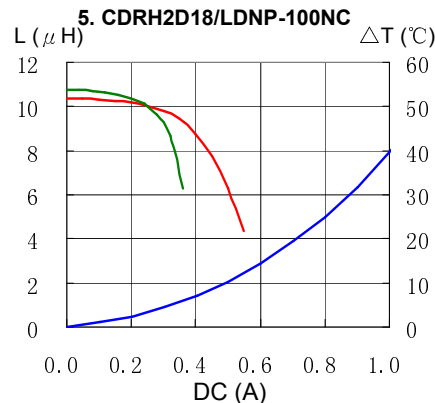
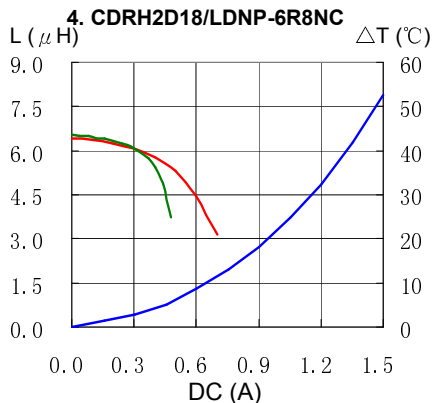
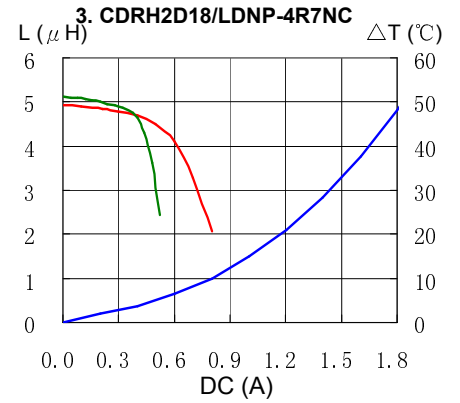
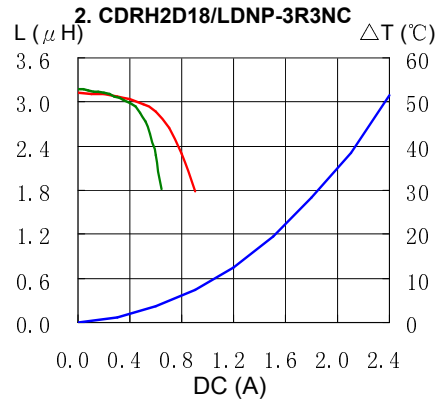
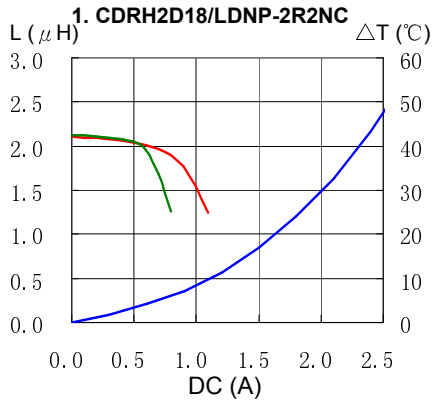

SMD Power Inductor CDRH2D18/LD



Solder Reflow Condition

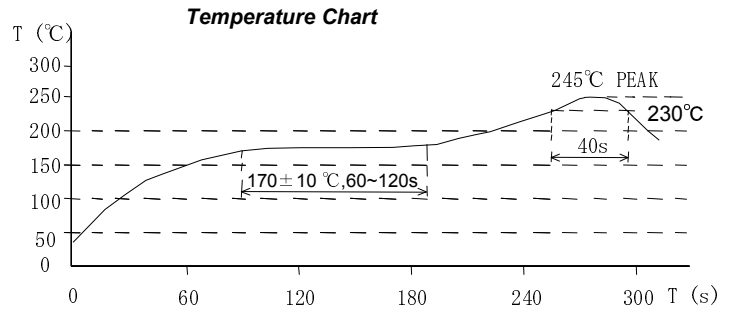
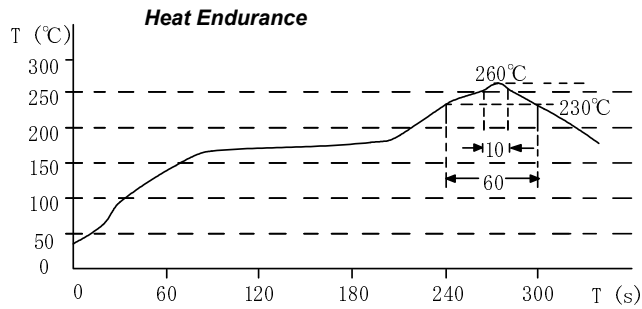

Please refer to the sales offices on our website - <http://www.sumida.com>

Hong Kong

Tel.+852-2880-6781
FAX.+852-2565-9600
sales@hk.sumida.com

Saitama(Japan)

Tel.+81-48-691-7300
FAX.+81-48-691-7340
sales@jp.sumida.com

Chicago

Tel.+1-847-545-6700
FAX. +1-847-545-6720
sales@us.sumida.com

Shanghai

Tel.+86-21-5836-3299
FAX.+86-21-5836-3266
shanghai.sales@cn.sumida.com

Seoul

Tel.+82-2-6237-0777
FAX.+82-2-6237-0778
sales@kr.sumida.com

Oberzell

Tel.+49-8591-937-0
FAX. +49-8591-937-103
contact@eu.sumida.com

Shenzhen

Tel.+86-755-8291-0228
FAX.+86-755-8291-0338
shenzhen.sales@cn.sumida.com

Singapore

Tel.+65-6296-3388
FAX.+65-6841-4426
sales@sg.sumida.com

Neumarkt

Tel.+49-9181-4509-110
FAX. +49-9181-4509-310
infocomp@eu.sumida.com

Taipei

Tel.+886-2-8751-2737
FAX.+886-2-8751-2738
sales@tw.sumida.com

San Jose

Tel.+1-408-321-9660
FAX.+1-408-321-9308
sales@us.sumida.com

Looking for pricing, stock, or lifecycle information?

Click below to explore more details on WIN SOURCE:

- ⊖ [View CDRH2D18/LDNP-4R7NC on WIN SOURCE](#)
- ⊖ [Sumida America Components Inc. Information](#)

Optimize Your Supply Chain with WIN SOURCE Solutions

- ✓ Global Sourcing Solution
- ✓ Obsolete Management
- ✓ Cost Control Management
- ✓ Shortage Management
- ✓ Alternative Solution
- ✓ Excess Inventory Management