



**THE DATASHEET OF
CDRH62B-4R0NC**



SPECIFICATION		
	SUMIDA TYPE CDRH62B	PART NO. REF. TO THE ATTACHED SHEET.

1. DIMENSION (UNIT mm)

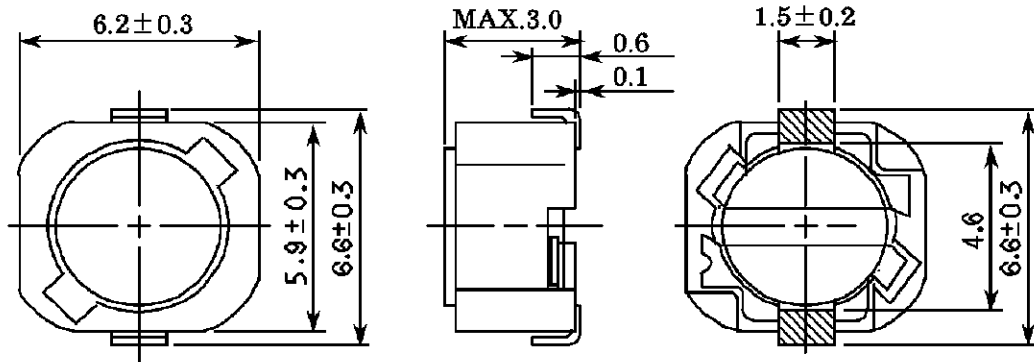

* DIMENSION WITHOUT TOLERANCE ARE APPROX.

 ELECTRODE TERMINAL

2. CONNECTION

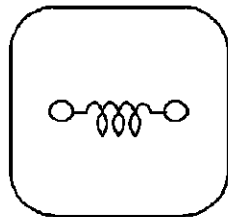

3. STAMP (Ex.)

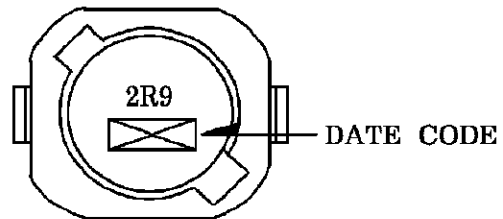

DIRECTLY STAMP
UNFIXED THE POSITION

4. NOTE

* PLEASE DO NOT USE A WASHING AGENT.

* ENCLOSING CONDITION OF COILS.

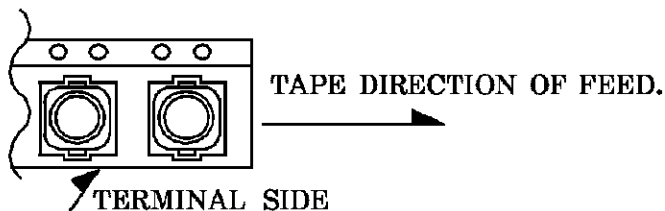

* CARRIER TAPE PACKING SPECIFICATION IN DETAIL.(S-074-462)

* RECOMMENDED REFLOW CONDITION TO BE ACCORDING TO S-074-5003.

15 th FEB . , 1996			SUMIDA CODE	4742
CHK.	CHK.	DRG.	DRG. NO. 2/5	
KOMA				
ITA	MAKABE	MONMA	S-074-525	
		M		

GENERAL CHARACTERISTICS

TYPE	CDRH62B
------	---------

1. OPERATING TEMPERATURE : - 30 ~ +100 °C (COIL CONTAIN HEAT)
2. EXTERNAL APPEARANCE : ON VISUAL INSPECTION, THE COIL HAS NO EXTERNAL DEFECTS.
3. ELECTRODE STRENGTH Δ : AFTER SOLDERING, BETWEEN COPPER PLATE AND ELECTRODE OF COIL, PUSH IN TWO DIRECTIONS OF X, Y WITHSTANDING 5.0N(0.51kgf) FOR 10±2 SECONDS. ELECTRODE SHOULD NOT PEEL OFF. (REFER TO FIGURE AT RIGHT)

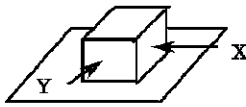
4. HEAT ENDURANCE TEST : REFER TO S-074-5002.
5. DIELECTRIC STRENGTH : NO APPARENT AT 100V D.C. FOR 1 MINUTE BETWEEN COIL-CORE.
6. INSULATING RESISTANCE : OVER 100 MΩ AT 100V D.C. BETWEEN COIL-CORE.
7. INDUCTANCE TEMPERATURE COEFFICIENT : (0 ~ 2000)×10⁻⁶/°C (-25 ~ + 80 °C)
8. HUMIDITY TEST : INDUCTANCE DEVIATION WITHIN ± 5.0 %
 AFTER 96 HOURS IN 90 ~ 95 % RELATIVE HUMIDITY AT 40 ± 2 °C AND 1 HOUR DRYING UNDER NORMAL CONDITION.
9. VIBRATION TEST : INDUCTANCE DEVIATION WITHIN ± 3.0 % AFTER VIBRATION FOR 1 HOUR. IN EACH OF THREE ORIENTATIONS AT SWEEP VIBRATION (10~55~10 Hz) WITH 1.5 mm P-P AMPLITUDE.
10. SHOCK TEST : INDUCTANCE DEVIATION WITHIN ± 3.0 % AFTER DROP DOWN WITH 981m/s²(100G) SHOCK ATTITUDE UPON A RUBBER BLOCK METHOD SHOCK TESTING MACHINE, FOR 1 TIME, IN EACH OF THREE ORIENTATIONS.

15 th FEB . , 1996

CHK.	CHK.	DRG.
KOMA		
ITA	MAKABE	MONMA
		M

DRG. NO.	3/5
S-074-525	

SPECIFICATION

TYPE	CDRH62B
------	---------

ELECTRICAL CHARACTERISTICS

NO.	PART NO.	STAMP	INDUCTANCE [WITHIN] ※1	D.C.R. (Ω, at 20°C) ※2	RATED CURRENT (A) ※3	SUMIDA CODE
01	CDRH62B-2R9NC	2R9	2.9 μH + 40 % - 20 %	68 m (50 m)	1.94	4742-0255
02	CDRH62B-4R0NC	4R0	4.0 μH + 40 % - 20 %	80 m (59 m)	1.63	4742-0266
03	CDRH62B-5R5NC	5R5	5.5 μH + 40 % - 20 %	96 m (71 m)	1.40	4742-0277
04	CDRH62B-6R3NC	6R3	6.3 μH + 40 % - 20 %	0.10 (77m)	1.30	4742-0288
05	CDRH62B-7R1NC	7R1	7.1 μH + 40 % - 20 %	0.11 (81m)	1.22	4742-0299
06	CDRH62B-8R0NC	8R0	8.0 μH + 40 % - 20 %	0.12 (87m)	1.15	4742-0301
07	CDRH62B-100MC	100	10 μH ± 20 %	0.15 (0.11)	1.10	4742-0312
08	CDRH62B-120MC	120	12 μH ± 20 %	0.20 (0.15)	1.00	4742-0323
09	CDRH62B-150MC	150	15 μH ± 20 %	0.23 (0.17)	0.90	4742-0334
10	CDRH62B-180MC	180	18 μH ± 20 %	0.27 (0.20)	0.80	4742-0345
11	CDRH62B-220MC	220	22 μH ± 20 %	0.34 (0.25)	0.74	4742-0356
12	CDRH62B-270MC	270	27 μH ± 20 %	0.38 (0.29)	0.66	4742-0367
13	CDRH62B-330MC	330	33 μH ± 20 %	0.45 (0.33)	0.59	4742-0378
14	CDRH62B-390MC	390	39 μH ± 20 %	0.49 (0.37)	0.54	4742-0389
15	CDRH62B-470MC	470	47 μH ± 20 %	0.69 (0.51)	0.50	4742-0390
16	CDRH62B-560MC	560	56 μH ± 20 %	0.78 (0.58)	0.46	4742-0401
17	CDRH62B-680MC	680	68 μH ± 20 %	1.07 (0.83)	0.42	4742-0412
18	CDRH62B-820MC	820	82 μH ± 20 %	1.21 (0.93)	0.38	4742-0423
19	CDRH62B-101MC	101	100 μH ± 20 %	1.39 (1.07)	0.34	4742-0434
20	CDRH62B-121MC	121	120 μH ± 20 %	1.90 (1.46)	0.31	4742-0445
21	CDRH62B-151MC	151	150 μH ± 20 %	2.18 (1.68)	0.28	4742-0456
22	CDRH62B-181MC	181	180 μH ± 20 %	2.77 (2.13)	0.26	4742-0467
23	CDRH62B-221MC	221	220 μH ± 20 %	3.12 (2.40)	0.23	4742-0478
24	CDRH62B-271MC	271	270 μH ± 20 %	4.38 (3.37)	0.22	4742-0489
25	CDRH62B-331MC	331	330 μH ± 20 %	4.94 (3.80)	0.19	4742-0491

※ 1: 2.9 μH ~ 8.0 μH ; INDUCTANCE (L) MEASURED AT A FREQUENCY OF 7.96 MHz
 10 μH ~ 330 μH ; INDUCTANCE (L) MEASURED AT A FREQUENCY OF 1 kHz

※ 2: D.C.R. () TYPICAL BALUE.

※ 3: THIS INDICATES THE VALUE OF CURRENT WHEN THE INDUCTANCE IS 75% MORE THAN IT'S NOMINAL VALUE AND TEMPERATURE RISING Δt=40°C LOWER AT D. C. SUPERPOSITION. (Ta=20°C)

15 th FEB . , 1996			SUMIDA CODE	4742
C H K.	C H K.	D R G.	DEG NO. 4/5 <h2 style="text-align: center;">S-074-525</h2>	
KOMA				
ITA	MAKABE	MONMA M		

SPECIFICATION

TYPE	CDRH62B
------	---------

DIMENSION RECOMMENDED (mm)

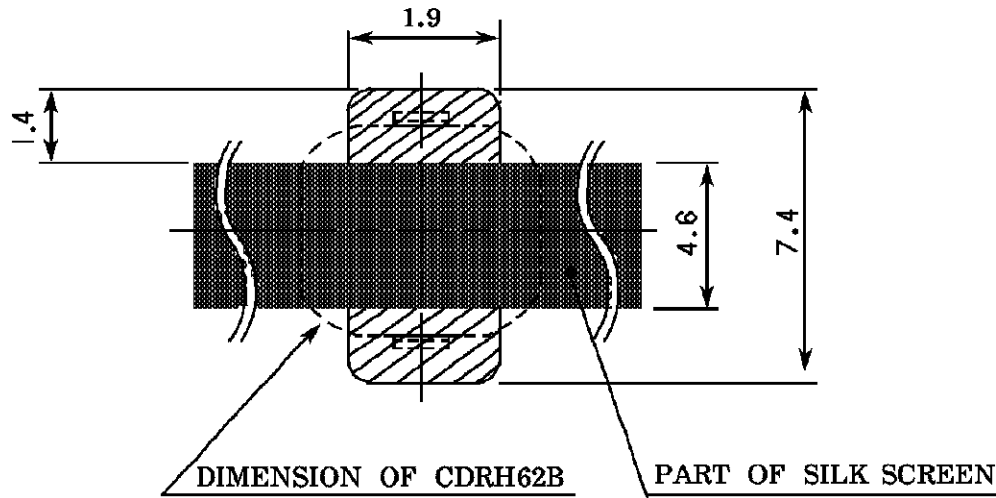

PLEASE COAT WITH SILK BETWEEN ELECTRODE. ⚠

15 th FEB . , 1996

C H K.	C H K.	D R G.
KOMA		
ITA	MAKABE	MONMA
		M

DRG. NO.	5/5
S-074-525	

Looking for pricing, stock, or lifecycle information?

Click below to explore more details on WIN SOURCE:

- ⊖ [View CDRH62B-4R0NC on WIN SOURCE](#)
- ⊖ [Sumida America Components Inc. Information](#)

Optimize Your Supply Chain with WIN SOURCE Solutions

- ✓ Global Sourcing Solution
- ✓ Obsolete Management
- ✓ Cost Control Management
- ✓ Shortage Management
- ✓ Alternative Solution
- ✓ Excess Inventory Management