



THE DATASHEET OF CDRH6D38NP-6R2NC



SMD Power Inductor CDRH6D38



Halogen Free

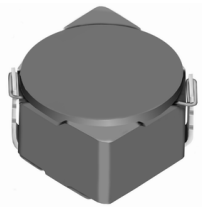

Description

- Ferrite drum core construction.
- Magnetically shielded.
- L × W × H: 7.0 × 7.0 × 4.0 mm Max.
- Product weight: 0.6g(Ref.)
- Moisture Sensitivity Level: 1
- RoHS compliance.
- Halogen Free available.

Environmental Data

- Operating temperature range: -40°C~+100°C (including coil's self temperature rise)
- Storage temperature range: -40°C~+100°C
- Solder reflow temperature: 260 °C peak.

Packaging

- Carrier tape and reel packaging
- 13" diameter reel
- 1000pcs per reel

Applications

- Ideally used in Game machine, HDD, Notebook PC, Projector, PDA, etc as DC-DC converter inductors.

Dimension - [mm]

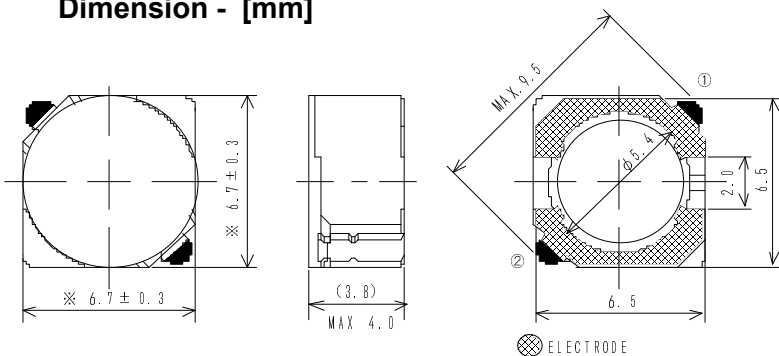

Land pattern and Schematics - [mm]

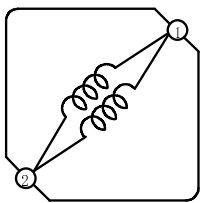
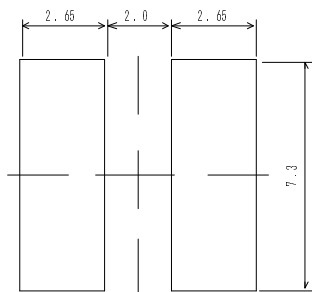

(3.3 μ H ~ 15 μ H)

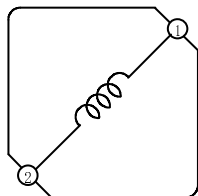

(18 μ H ~ 100 μ H)

SMD Power Inductor CDRH6D38



Electrical Characteristics

Part Name	Stamp	Inductance (μH) [within] ※1	D.C.R.(Ω) Max. (Typ.) (at 20°C)	Rated Current (A) ※2
CDRH6D38NP-3R3NC	3R3	3.3±30%	20m (15m)	3.50
CDRH6D38NP-5R0NC	5R0	5.0±30%	24m (18m)	2.90
CDRH6D38NP-6R2NC	6R2	6.2±30%	27m (20m)	2.50
CDRH6D38NP-7R4NC	7R4	7.4±30%	31m (23m)	2.30
CDRH6D38NP-8R7NC	8R7	8.7±30%	34m (25m)	2.20
CDRH6D38NP-100NC	100	10±30%	38m (28m)	2.00
CDRH6D38NP-120NC	120	12±30%	53m (39m)	1.70
CDRH6D38NP-150NC	150	15±30%	57m (42m)	1.60
CDRH6D38NP-180NC	180	18±30%	92m (68m)	1.50
CDRH6D38NP-220NC	220	22±30%	96m (71m)	1.30
CDRH6D38NP-270NC	270	27±30%	109m (81m)	1.20
CDRH6D38NP-330NC	330	33±30%	124m (92m)	1.10
CDRH6D38NP-390NC	390	39±30%	138m(102m)	1.00
CDRH6D38NP-470NC	470	47±30%	155m(115m)	0.95
CDRH6D38NP-560NC	560	56±30%	202m(150m)	0.85
CDRH6D38NP-680NC	680	68±30%	234m(173m)	0.75
CDRH6D38NP-820NC	820	82±30%	324m(240m)	0.70
CDRH6D38NP-101NC	101	100±30%	358m(265m)	0.65

※1. Inductance measuring condition: at 100kHz.

※2. Rated current: The DC current at which the inductance decreases to 65% of it's nominal value or when $\Delta t=30^\circ\text{C}$, whichever is lower ($T_a=20^\circ\text{C}$).

SMD Power Inductor CDRH6D38



Saturation Current & Temperature Rise Graph

— L (20°C) — L (105°C) — ΔT

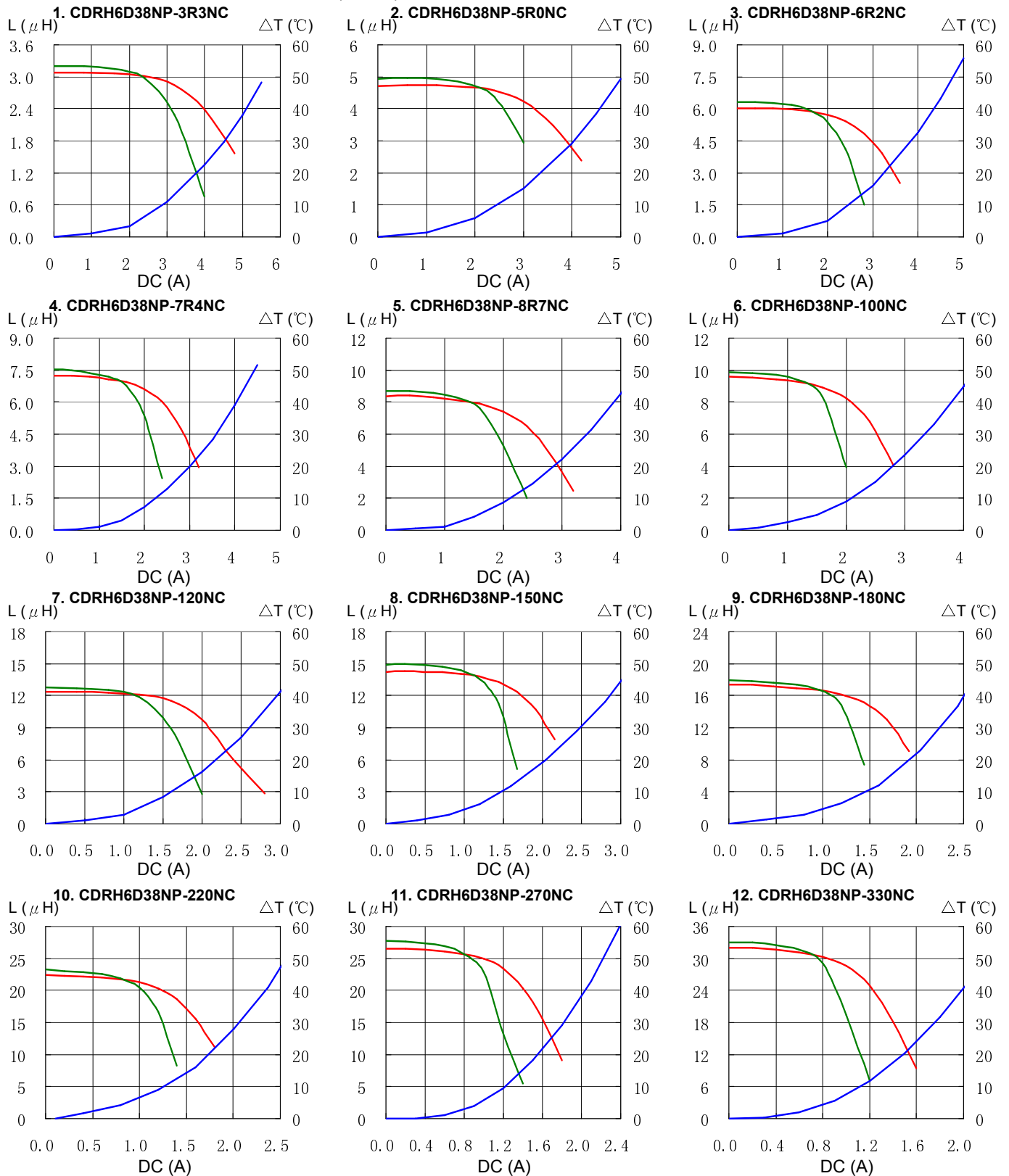

SMD Power Inductor CDRH6D38



Saturation Current & Temperature Rise Graph

— L (20°C) — L (105°C) — ΔT

13. CDRH6D38NP-390NC

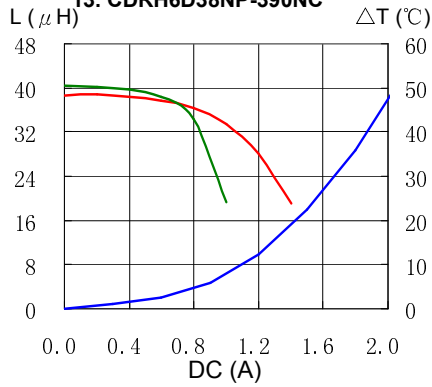

14. CDRH6D38NP-470NC

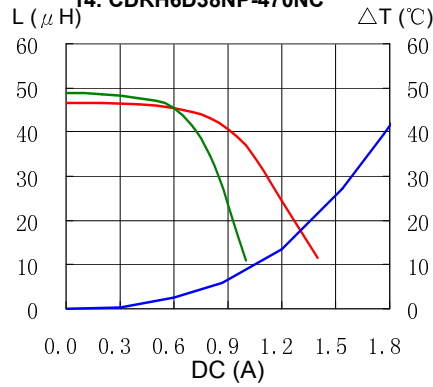

15. CDRH6D38NP-560NC

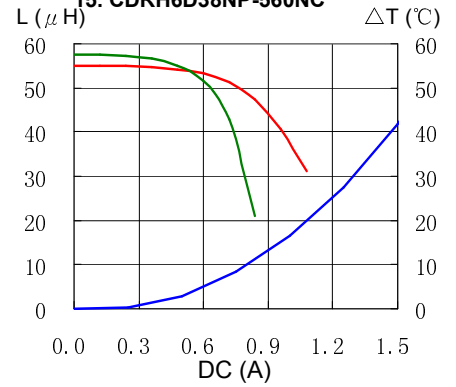

16. CDRH6D38NP-680NC

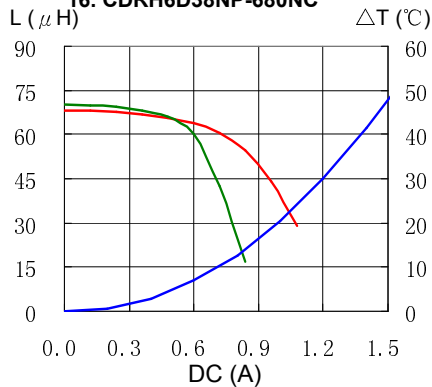

17. CDRH6D38NP-820NC

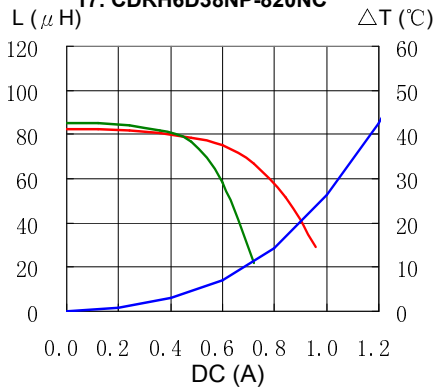

18. CDRH6D38NP-101NC

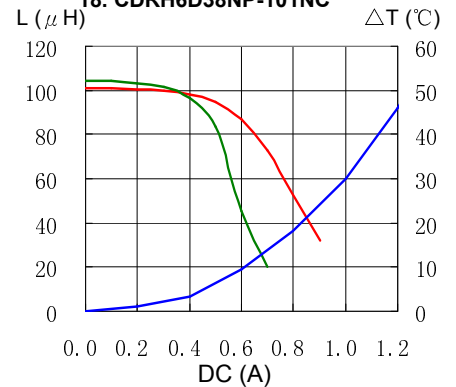

Solder Reflow Condition

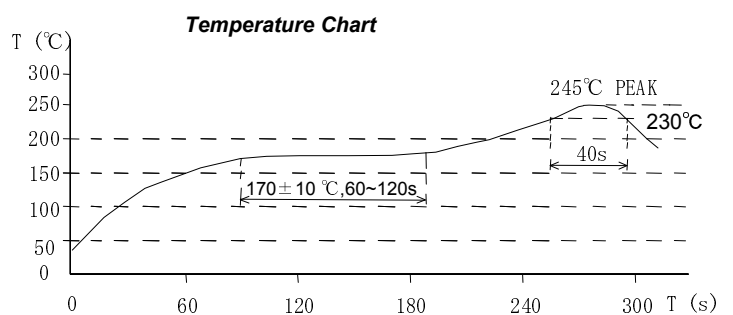
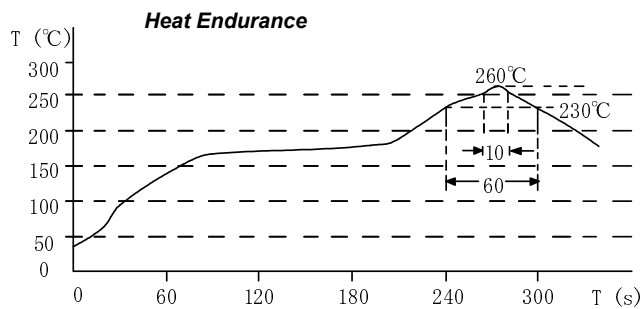

Please refer to the sales offices on our website - <http://www.sumida.com>

Hong Kong
Tel.+852-2880-6781
FAX.+852-2565-9600
sales@hk.sumida.com
Saitama(Japan)
Tel.+81-48-691-7300
FAX.+81-48-691-7340
sales@jp.sumida.com
Chicago
Tel.+1-847-545-6700
FAX. +1-847-545-6720
sales@us.sumida.com

Shanghai
Tel.+86-21-5836-3299
FAX.+86-21-5836-3266
shanghai.sales@cn.sumida.com
Seoul
Tel.+82-2-6237-0777
FAX.+82-2-6237-0778
sales@kr.sumida.com
Oberzell
Tel.+49-8591-937-0
FAX. +49-8591-937-103
contact@eu.sumida.com

Shenzhen
Tel.+86-755-8291-0228
FAX.+86-755-8291-0338
shenzhen.sales@cn.sumida.com
Singapore
Tel.+65-6296-3388
FAX.+65-6841-4426
sales@sg.sumida.com
Neumarkt
Tel.+49-9181-4509-110
FAX. +49-9181-4509-310
infocomp@eu.sumida.com

Taipei
Tel.+886-2-8751-2737
FAX.+886-2-8751-2738
sales@tw.sumida.com
San Jose
Tel.+1-408-321-9660
FAX.+1-408-321-9308
sales@us.sumida.com

Looking for pricing, stock, or lifecycle information?

Click below to explore more details on WIN SOURCE:

- ⊖ [View CDRH6D38NP-6R2NC on WIN SOURCE](#)
- ⊖ [Sumida America Components Inc. Information](#)

Optimize Your Supply Chain with WIN SOURCE Solutions

- ✓ Global Sourcing Solution
- ✓ Obsolete Management
- ✓ Cost Control Management
- ✓ Shortage Management
- ✓ Alternative Solution
- ✓ Excess Inventory Management