



**THE DATASHEET OF  
EE-SY1200**



## Photomicrosensor (Reflective) EE-SY1200

**⚠ Be sure to read Precautions on page 24.**

### ■ Dimensions

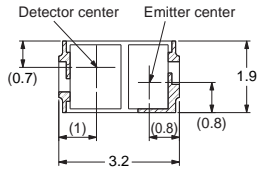

**Note:**  
Unless otherwise specified tolerances are  $\pm 0.15$ .  
No burrs dimensions are included in outline dimensions.  
The burrs dimensions are 0.15 MAX.  
Diagonal line indicate the region is part Au plating area.

### Recommended Soldering Pattern

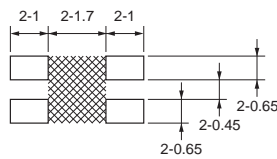

**Note:1.** The shaded portion in the above figure may cause shorting. Do not wire in this portion.  
**2.** The dimensional tolerance for the recommended soldering pattern is  $\pm 0.1$  mm.

### Internal Circuit

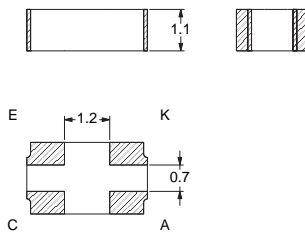
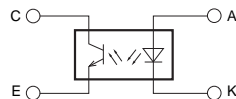

Terminal No.	Name
A	Anode
K	Cathode
C	Collector
E	Emitter

### ■ Features

- Ultra-compact model.
- PCB surface mounting type.
- High S/N ratio (High light current / Low leakage current)
- Recommended sensing distance = 1.0 to 4.0 mm

### ■ Absolute Maximum Ratings (Ta=25°C)

Item	Symbol	Rated value	Unit
Emitter	Forward current	$I_F$	$50^{*1}$ mA
	Pulse forward current	$I_{FP}$	$500^{*2}$ mA
	Reverse voltage	$V_R$	4 V
Detector	Collector-Emitter voltage	$V_{CEO}$	30 V
	Emitter-Collector voltage	$V_{ECO}$	5 V
	Collector current	$I_C$	20 mA
	Collector dissipation	$P_C$	$50^{*1}$ mW
Operating temperature	$T_{opr}$	-25 to +85	°C
Storage temperature	$T_{stg}$	-40 to +100	°C
Reflow soldering temperature	$T_{sol}$	$240^{*3}$	°C

\*1 Refer to the temperature rating chart if the ambient temperature exceeds 25°C.

\*2 The pulse width is 10  $\mu$ s maximum with a frequency of 100 Hz.

\*3 Complete soldering within 10 seconds for reflow soldering.

### ■ Electrical and Optical Characteristics (Ta=25°C)

Item	Symbol	Value			Unit	Condition	
		MIN.	TYP.	MAX.			
Emitter	Forward voltage	$V_F$	---	1.2	1.4	V	$I_F = 20$ mA
	Reverse current	$I_R$	---	---	10	$\mu$ A	$V_R = 4$ V
	Peak emission wavelength	$\lambda_p$	---	940	---	nm	---
Detector	Light current 1	$I_{L1}$	200	---	1000	$\mu$ A	$I_F = 10$ mA, $V_{CE} = 2$ V, Aluminum-deposited surface, $d = 4$ mm <sup>*1</sup>
	Light current 2	$I_{L2}$	150	---	---	$\mu$ A	$I_F = 4$ mA, $V_{CE} = 2$ V, Aluminum-deposited surface, $d = 1$ mm <sup>*1</sup>
	Dark current	$I_D$	---	2	200	nA	$V_{CE} = 10$ V, 0 lx
	Leakage current 1	$I_{LEAK1}$	---	---	500	nA	$I_F = 10$ mA, $V_{CE} = 2$ V, with no reflection <sup>*2</sup>
	Leakage current 2	$I_{LEAK2}$	---	---	200	nA	$I_F = 4$ mA, $V_{CE} = 2$ V, with no reflection <sup>*2</sup>
	Collector-Emitter saturated voltage	$V_{CE}(\text{sat})$	---	---	---	V	---
	Peak spectral sensitivity wavelength	$\lambda_p$	---	850	---	nm	---
Rising time	$t_r$	---	30	---	$\mu$ s	$V_{CC} = 2$ V, $R_L = 1$ k $\Omega$ , $I_L = 100$ $\mu$ A, $d = 1$ mm <sup>*1</sup>	
Falling time	$t_f$	---	30	---	$\mu$ s	$V_{CC} = 2$ V, $R_L = 1$ k $\Omega$ , $I_L = 100$ $\mu$ A, $d = 1$ mm <sup>*1</sup>	

\*1. The letter "d" indicates the distance between the top surface of the sensor and the sensing object.

\*2. Depends on the installed condition of the Photomicrosensor, the detector may receive the sensor's LED light and/or the external light which is reflected from surroundings of the Photomicrosensor and/or the background object.

Please confirm the condition of the Photomicrosensor by actual intended application prior to the mass production use.

**Engineering Data**

**Forward Current vs. Collector Dissipation Temperature Rating**

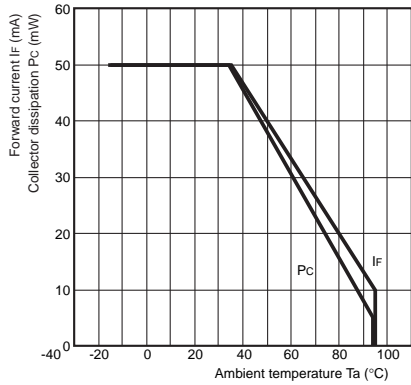

**Forward Current vs. Forward Voltage Characteristics (Typical)**

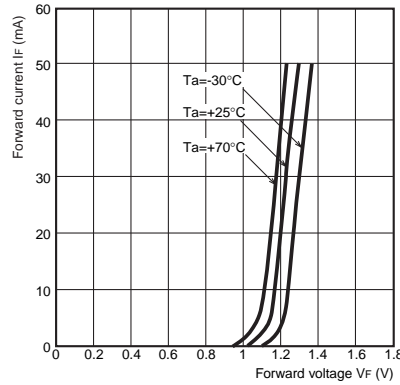

**Light Current vs. Forward Current Characteristics (Typical)**

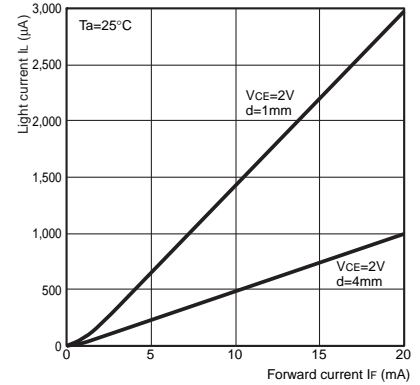

**Light Current vs. Collector-Emitter Voltage Characteristics (Typical)**

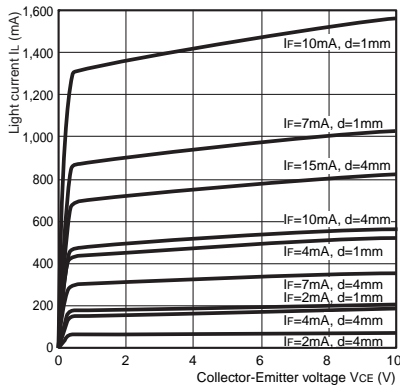

**Relative Light Current vs. Ambient Temperature Characteristics (Typical)**

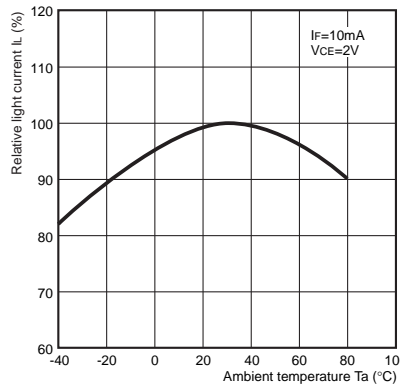

**Dark Current vs. Ambient Temperature Characteristics (Typical)**

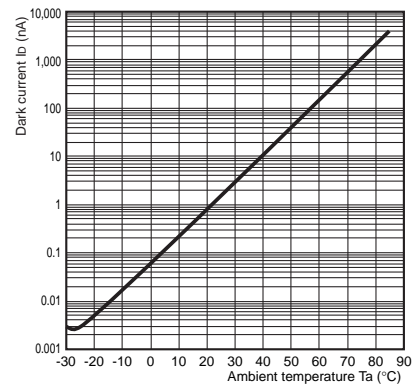

**Response Time vs. Load Resistance Characteristics (Typical)**

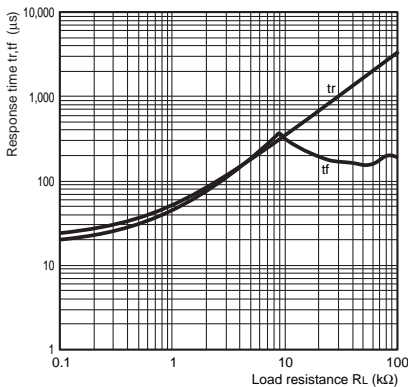

**Sensing Distance Characteristics (Typical)**

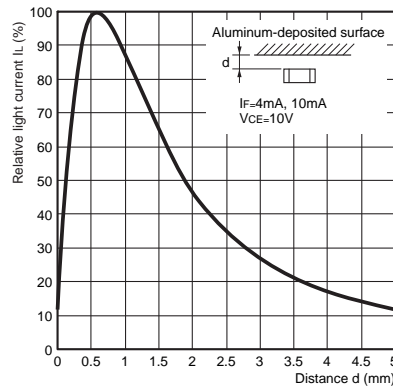

**Sensing Position Characteristics (Typical)**

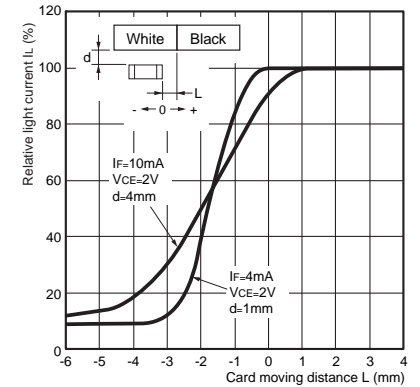

**Sensing Position Characteristics (Typical)**

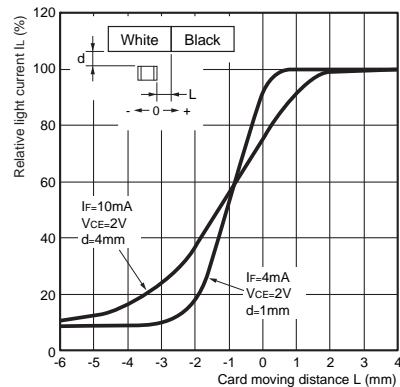

**Response Time Measurement Circuit**

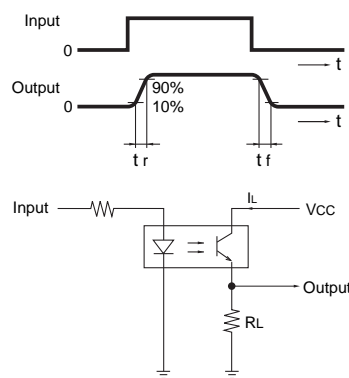

**Light Current Measurement Setup Diagram**

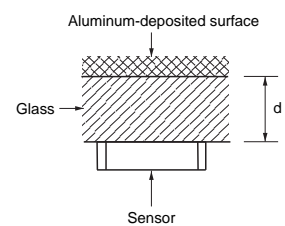

■ Tape and Reel

Reel Dimension (Unit: mm)

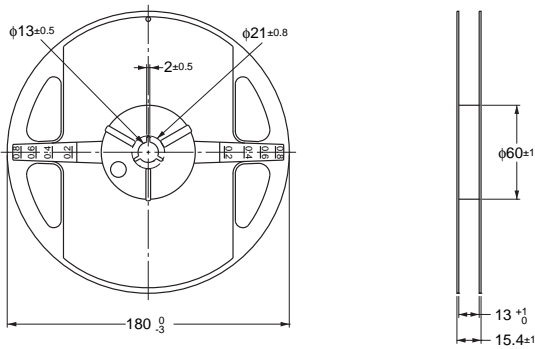

Tape Dimension (Unit: mm)

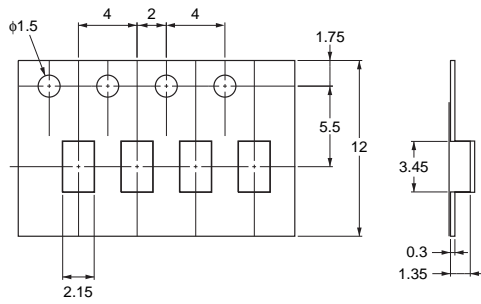

Part Mounting Direction

- The devices are oriented in the rectangular holes in the carrier tape so that the edge with the LED faces the round feeding holes.

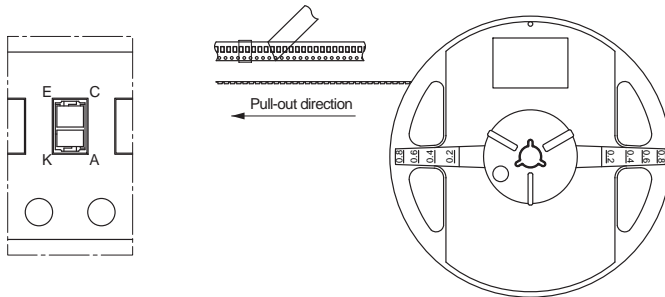

Tape Quantity

2,000 pcs./reel

**■ Precautions to be taken on mounting**

**Temperature Profile**

The reflow soldering can be implemented in two times complying with the following diagram.

All the temperatures in the product must be within the diagram.

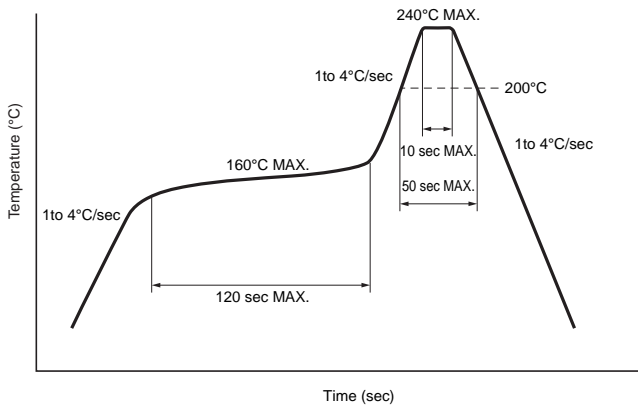

**Treatment after Opening**

1. Reflow soldering must be done within 48 hours stored at the conditions of humidity 60%RH or less and temperature 5 to 25°C.
2. In case of long time storage after open, please mount at the conditions of humidity 70%RH or less and temperature 5 to 30°C within 1 week by using dry box or resealing with desiccant in moisture-proof bag by sealer.

**Baking before Mounting**

In case that it could not carry out the above treatment, it is able to mount by baking treatment.

However baking treatment shall be limited only 1 time.

- Recommended conditions :
- 60°C, 12 to 24 hours (reeled one)
  - 100°C, 8 to 24 hours (loose one)

**Manual soldering**

The manual soldering cannot be applied to the products.

There is a possibility that the housing is deformed and/or Au plating is peeled off by heat.

**Other Notes**

The use of infrared lamp causes the temperature at the resin to rise particularly too high.

All the temperatures in the product must be within the above diagram.

Do not immerse the resin part into the solder.

Even if within the above temperature diagram, there is a possibility that the gold wire in the products is broken in case that the deformation of PCB gives the stress to the product terminals.

Please confirm the conditions of the reflow soldering fully by actual solder reflow machine prior to the mass production use.

**■ Storage and Handling after Opening**

**Storage Conditions**

In order to avoid the absorption of moisture, the products shall be stored in a dry box with desiccant or in the following conditions.

Storage temp. : 5 to 30°C

Storage humidity : 70%RH or less

## Looking for pricing, stock, or lifecycle information?

Click below to explore more details on WIN SOURCE:

 [View EE-SY1200 on WIN SOURCE](#)

 [Omron Information](#)

## Optimize Your Supply Chain with WIN SOURCE Solutions

-  Global Sourcing Solution
-  Obsolete Management
-  Cost Control Management
-  Shortage Management
-  Alternative Solution
-  Excess Inventory Management