



**THE DATASHEET OF  
FDS4435BZ**



# FDS4435BZ

## MOSFET – P-Channel, POWERTRENCH®

**-30 V, -8.8 A, 20 mΩ**

### Description

This P-Channel MOSFET is produced using ON Semiconductor's advanced POWERTRENCH process that has been especially tailored to minimize the on-state resistance.

This device is well suited for Power Management and load switching applications common in Notebook Computers and Portable Battery Packs.

### Features

- Max  $R_{DS(on)}$  = 20 mΩ at  $V_{GS} = -10$  V,  $I_D = -8.8$  A
- Max  $R_{DS(on)}$  = 35 mΩ at  $V_{GS} = -4.5$  V,  $I_D = -6.7$  A
- Extended  $V_{GSS}$  Range (-25 V) for Battery Applications
- HBM ESD Protection Level of ±3.8 kV Typical (Note 3)
- High Performance Trench Technology for Extremely Low  $R_{DS(on)}$
- High Power and Current Handling Capability
- This Device is Pb-Free and RoHS Compliant

### Specifications

#### MAXIMUM RATINGS ( $T_A = 25^\circ\text{C}$ unless otherwise noted)

Symbol	Parameter	Ratings	Unit
$V_{DS}$	Drain to Source Voltage	-30	V
$V_{GS}$	Gate to Source Voltage	±25	V
$I_D$	Drain Current – Continuous $T_A = 25^\circ\text{C}$ (Note 1a) – Pulsed	-8.8 -50	A
$P_D$	Power Dissipation $T_A = 25^\circ\text{C}$ (Note 1a)	2.5	W
	Power Dissipation $T_A = 25^\circ\text{C}$ (Note 1b)	1.0	
$E_{AS}$	Single Pulse Avalanche Energy (Note 4)	24	mJ
$T_J, T_{STG}$	Operating and Storage Junction Temperature Range	-55 to +150	$^\circ\text{C}$

Stresses exceeding those listed in the Maximum Ratings table may damage the device. If any of these limits are exceeded, device functionality should not be assumed, damage may occur and reliability may be affected.

#### THERMAL CHARACTERISTICS

Symbol	Parameter	Ratings	Unit
$R_{\theta JC}$	Thermal Resistance, Junction to Case	25	$^\circ\text{C}/\text{W}$
$R_{\theta JA}$	Thermal Resistance, Junction to Ambient (Note 1a)	50	



**ON Semiconductor®**

[www.onsemi.com](http://www.onsemi.com)

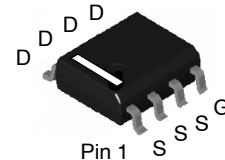

**SOIC8  
CASE 751EB**

### ELECTRICAL CONNECTION

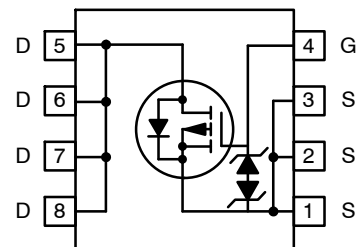

### MARKING DIAGRAM



FDS4435BZ = Specific Device Code  
A = Assembly Site  
L = Wafer Lot Number  
YW = Assembly Start Week

### ORDERING INFORMATION

Device	Package	Shipping†
FDS4435BZ	SOIC8 (Pb-Free)	2,500 / Tape & Reel

†For information on tape and reel specifications, including part orientation and tape sizes, please refer to our Tape and Reel Packaging Specification Brochure, BRD8011/D.

# FDS4435BZ

**Table 1. ELECTRICAL CHARACTERISTICS** ( $T_A = 25^\circ\text{C}$ )

Symbol	Parameter	Conditions	Min	Typ	Max	Unit
--------	-----------	------------	-----	-----	-----	------

## OFF CHARACTERISTICS

$BV_{DSS}$	Drain to Source Breakdown Voltage	$I_D = -250 \mu\text{A}$ , $V_{GS} = 0 \text{ V}$	-30			V
$\Delta BV_{DSS} / \Delta T_J$	Breakdown Voltage Temperature Coefficient	$I_D = -250 \mu\text{A}$ , referenced to $25^\circ\text{C}$		-21		$\text{mV}/^\circ\text{C}$
$I_{DSS}$	Zero Gate Voltage Drain Current	$V_{DS} = -24 \text{ V}$ , $V_{GS} = 0 \text{ V}$			1	$\mu\text{A}$
$I_{GSS}$	Gate to Source Leakage Current	$V_{GS} = \pm 25 \text{ V}$ , $V_{DS} = 0 \text{ V}$			$\pm 10$	$\mu\text{A}$

## ON CHARACTERISTICS

$V_{GS(th)}$	Gate to Source Threshold Voltage	$V_{GS} = V_{DS}$ , $I_D = -250 \mu\text{A}$	-1	-2.1	-3	V
$\Delta V_{GS(th)} / \Delta T_J$	Gate to Source Threshold Voltage Temperature Coefficient	$I_D = -250 \mu\text{A}$ , referenced to $25^\circ\text{C}$		6		$\text{mV}/^\circ\text{C}$
$R_{DS(on)}$	Static Drain to Source On Resistance	$V_{GS} = -10 \text{ V}$ , $I_D = -8.8 \text{ A}$		16	20	$\text{m}\Omega$
		$V_{GS} = -4.5 \text{ V}$ , $I_D = -6.7 \text{ A}$		26	35	
		$V_{GS} = -10 \text{ V}$ , $I_D = -8.8 \text{ A}$ , $T_J = 125^\circ\text{C}$		22	28	
$g_{FS}$	Forward Transconductance	$V_{DS} = -5 \text{ V}$ , $I_D = -8.8 \text{ A}$		24		S

## DYNAMIC CHARACTERISTICS

$C_{iss}$	Input Capacitance	$V_{DS} = -15 \text{ V}$ , $V_{GS} = 0 \text{ V}$ , $f = 1 \text{ MHz}$		1385	1845	$\text{pF}$
$C_{oss}$	Output Capacitance			275	365	
$C_{rss}$	Reverse Transfer Capacitance			230	345	
$R_g$	Gate Resistance	$f = 1 \text{ MHz}$		4.5		$\Omega$

## SWITCHING CHARACTERISTICS

$t_{d(on)}$	Turn-On Delay Time	$V_{DD} = -15 \text{ V}$ , $I_D = -8.8 \text{ A}$ , $V_{GS} = -10 \text{ V}$ , $R_{GEN} = 6 \Omega$		10	20	ns
$t_r$	Rise Time			6	12	
$t_{d(off)}$	Turn-Off Delay Time			30	48	
$t_f$	Fall Time			12	22	
$Q_g$	Total Gate Charge	$V_{GS} = 0 \text{ V}$ to $-10 \text{ V}$ , $V_{DD} = -15 \text{ V}$ , $I_D = -8.8 \text{ A}$		28	40	nC
$Q_g$	Total Gate Charge	$V_{GS} = 0 \text{ V}$ to $-5 \text{ V}$ , $V_{DD} = -15 \text{ V}$ , $I_D = -8.8 \text{ A}$		16	23	nC
$Q_{gs}$	Gate to Source Charge	$V_{DD} = -15 \text{ V}$ , $I_D = -8.8 \text{ A}$		5.2		nC
$Q_{gd}$	Gate to Drain "Miller" Charge			7.4		

## DRAIN-SOURCE DIODE CHARACTERISTICS

$V_{SD}$	Source to Drain Diode Forward Voltage	$V_{GS} = 0 \text{ V}$ , $I_S = -8.8 \text{ A}$ (Note 2)		-0.9	-1.2	V
$t_{rr}$	Reverse Recovery Time	$I_F = -8.8 \text{ A}$ , $di/dt = 100 \text{ A}/\mu\text{s}$		29	44	ns
$Q_{rr}$	Reverse Recovery Charge			23	35	

Product parametric performance is indicated in the Electrical Characteristics for the listed test conditions, unless otherwise noted. Product performance may not be indicated by the Electrical Characteristics if operated under different conditions.

## NOTES:

- $R_{\theta JA}$  is determined with the device mounted on a 1 in<sup>2</sup> pad 2 oz copper pad on a 1.5 × 1.5 in. board of FR-4 material.  $R_{\theta JC}$  is guaranteed by design while  $R_{\theta CA}$  is determined by the user's board design.



a.  $50^\circ\text{C}/\text{W}$  when mounted on a 1 in<sup>2</sup> pad of 2 oz copper.



b.  $125^\circ\text{C}/\text{W}$  when mounted on a minimum pad of 2 oz copper

- Pulse Test: Pulse Width < 300  $\mu\text{s}$ , Duty cycle < 2.0%.
- The diode connected between the gate and source serves only as protection against ESD. No gate overvoltage rating is implied.
- Starting  $T_J = 25^\circ\text{C}$ ,  $L = 1 \text{ mH}$ ,  $I_{AS} = -7 \text{ A}$ ,  $V_{DD} = -30 \text{ V}$ ,  $V_{GS} = -10 \text{ V}$ .

TYPICAL CHARACTERISTICS

( $T_J = 25^\circ\text{C}$  unless otherwise noted)

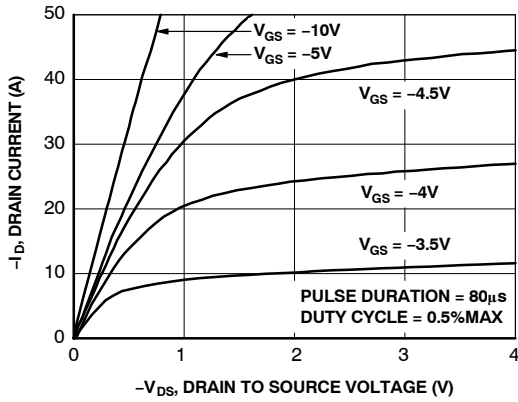

Figure 1. On-Region Characteristics

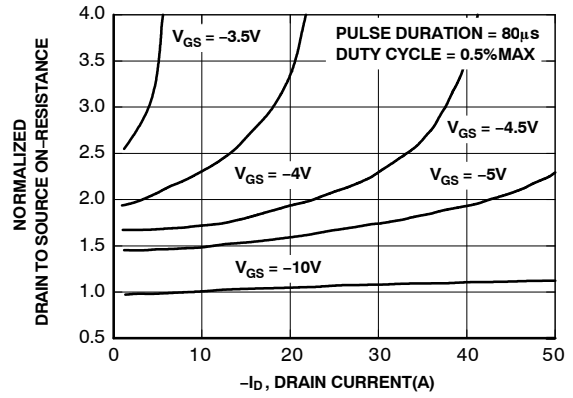

Figure 2. Normalized On-Resistance vs Drain Current and Gate Voltage

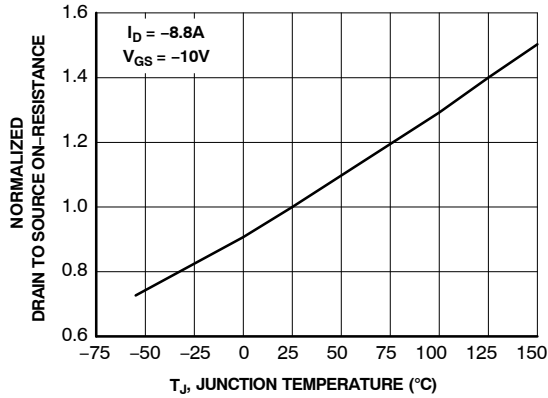

Figure 3. Normalized On-Resistance vs Junction Temperature

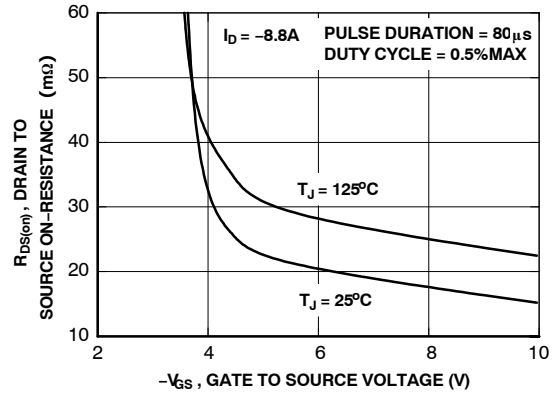

Figure 4. On-Resistance vs Gate to Source Voltage

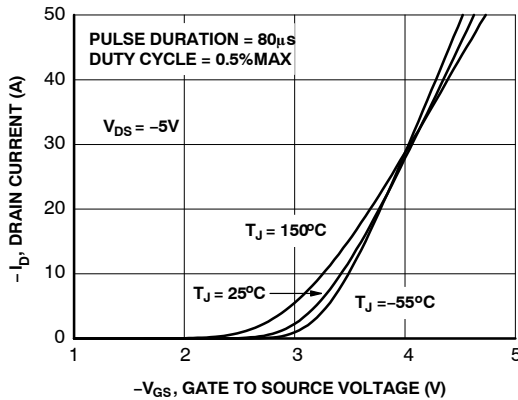

Figure 5. Transfer Characteristics

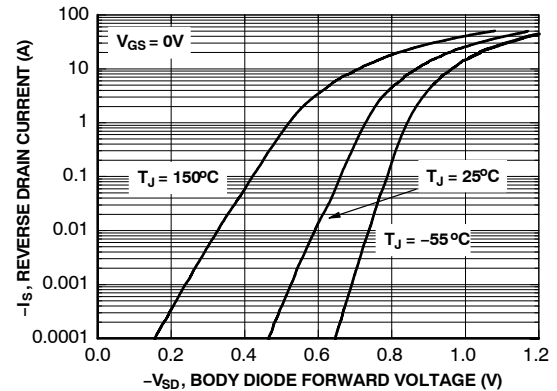

Figure 6. Source to Drain Diode Forward Voltage vs Source Current

# FDS4435BZ

## TYPICAL CHARACTERISTICS (Continued)

( $T_J = 25^\circ\text{C}$  unless otherwise noted)

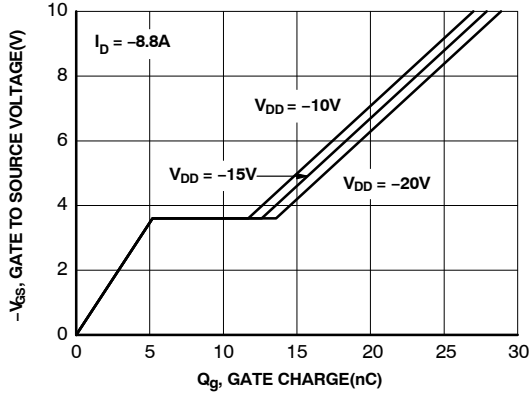

Figure 7. Gate Charge Characteristics

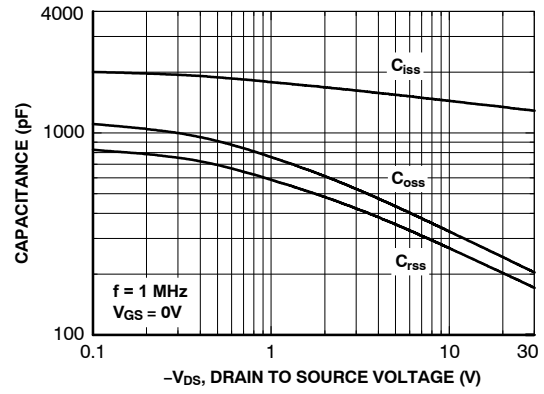

Figure 8. Capacitance vs Drain to Source Voltage

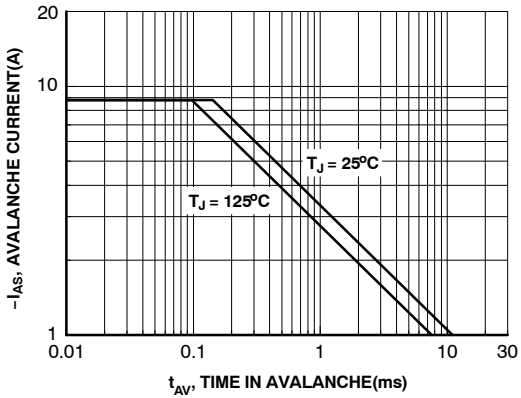

Figure 9. Unclamped Inductive Switching Capability

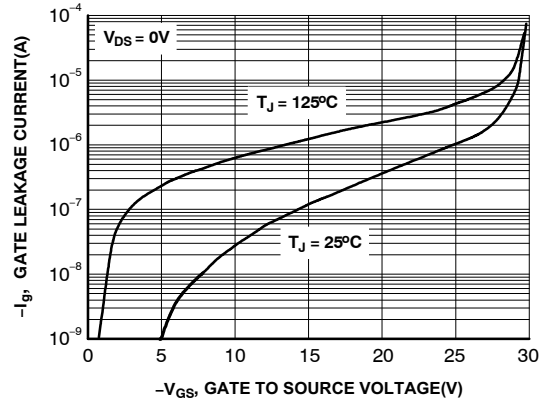

Figure 10. Gate Leakage Current vs Gate to Source Voltage

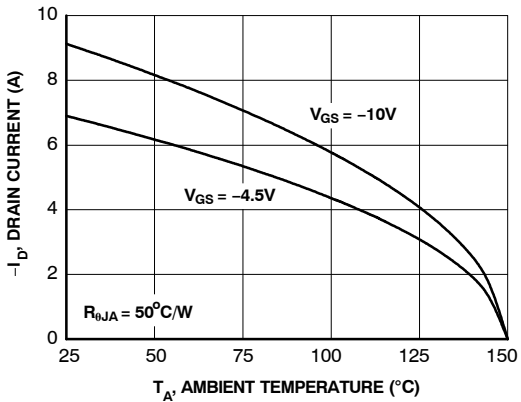

Figure 11. Maximum Continuous Drain Current vs Ambient Temperature

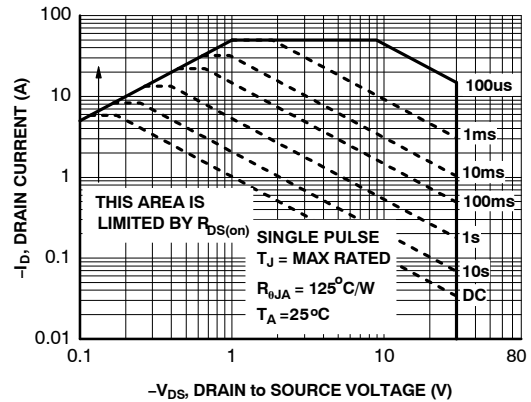

Figure 12. Forward Bias Safe Operating Area

TYPICAL CHARACTERISTICS (Continued)

( $T_J = 25^\circ\text{C}$  unless otherwise noted)

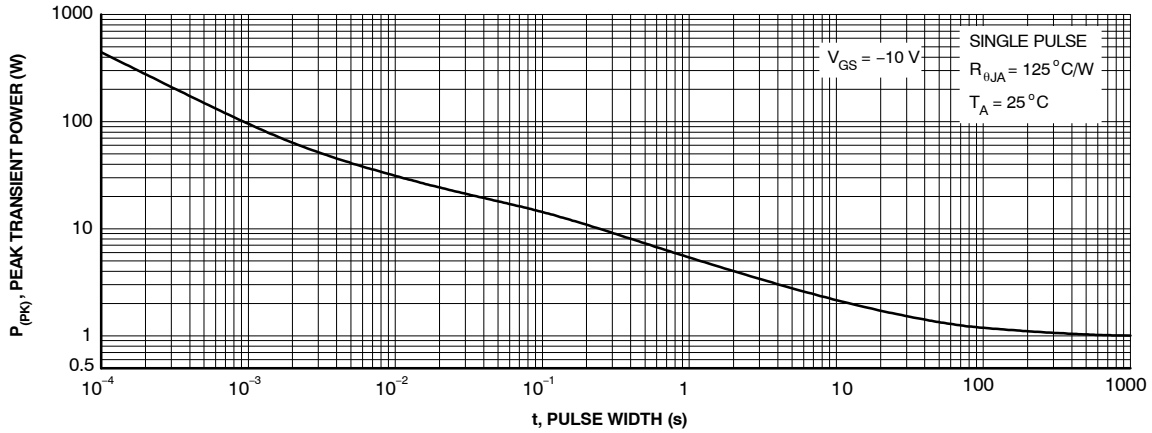

Figure 13. Single Pulse Maximum Power Dissipation

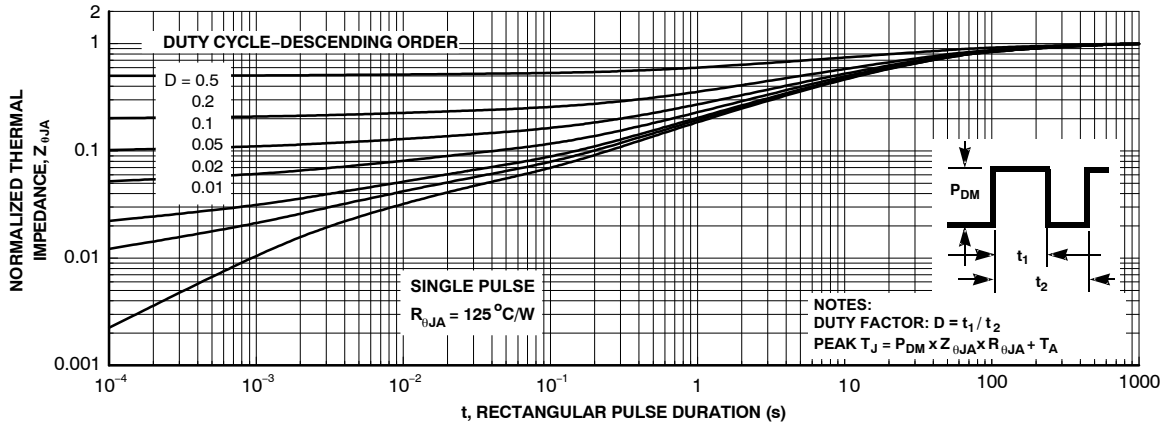

Figure 14. Junction To Ambient Transient Thermal Response Curve

POWERTRENCH is registered trademark of Semiconductor Components Industries, LLC (SCILLC) or its subsidiaries in the United States and/or other countries.

**MECHANICAL CASE OUTLINE**  
**PACKAGE DIMENSIONS**

ON Semiconductor®



**SOIC8**  
**CASE 751EB**  
**ISSUE A**

DATE 24 AUG 2017

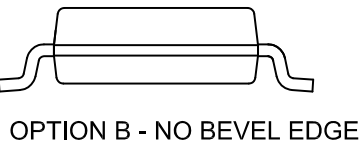
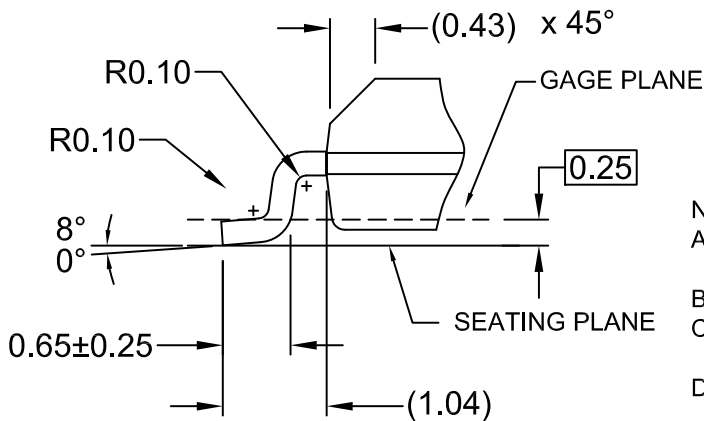
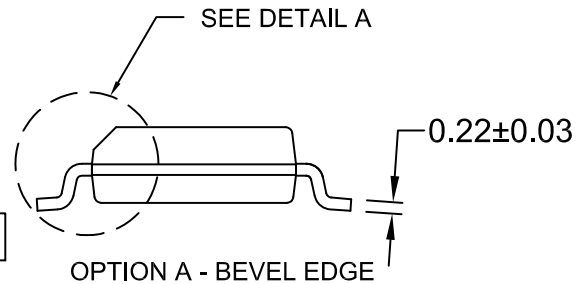
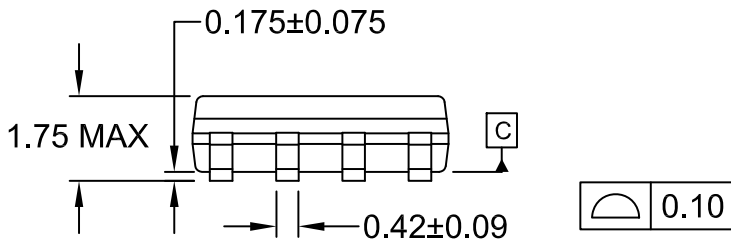
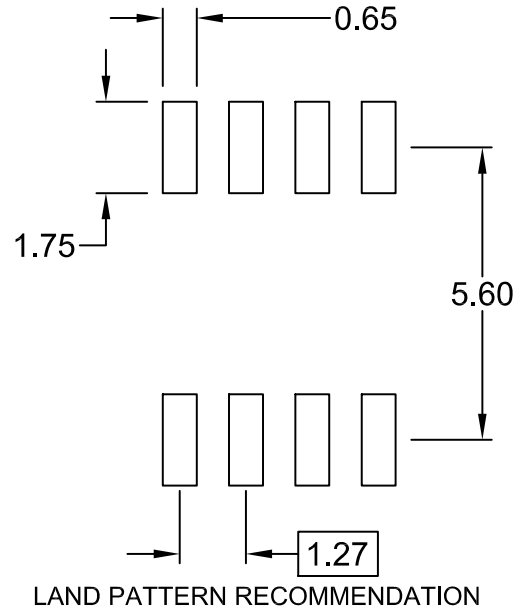
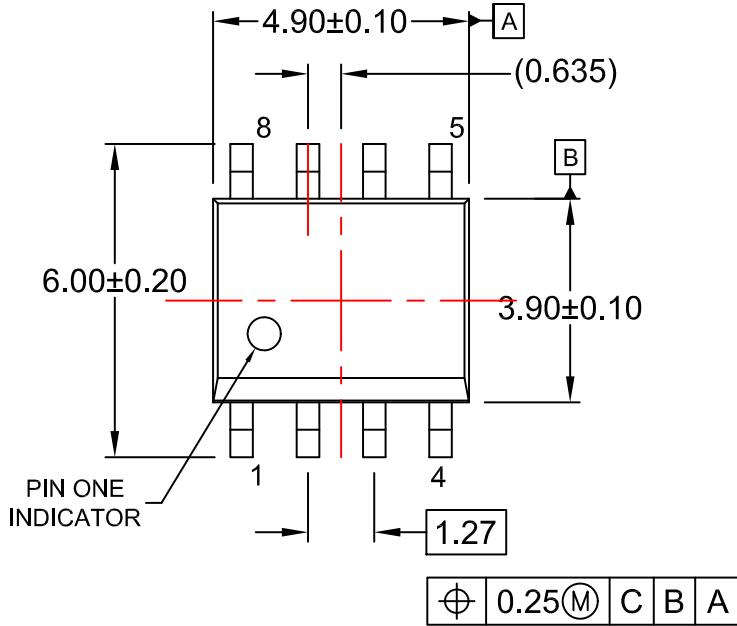

- NOTES:
- A) THIS PACKAGE CONFORMS TO JEDEC MS-012, VARIATION AA.
  - B) ALL DIMENSIONS ARE IN MILLIMETERS.
  - C) DIMENSIONS DO NOT INCLUDE MOLD FLASH OR BURRS.
  - D) LANDPATTERN STANDARD: SOIC127P600X175-8M

**DETAIL A**  
 SCALE: 2:1

<b>DOCUMENT NUMBER:</b>	<b>98AON13735G</b>	Electronic versions are uncontrolled except when accessed directly from the Document Repository. Printed versions are uncontrolled except when stamped "CONTROLLED COPY" in red.
<b>STATUS:</b>	<b>ON SEMICONDUCTOR STANDARD</b>	
<b>NEW STANDARD:</b>		
<b>DESCRIPTION:</b>	<b>SOIC8</b>	<b>PAGE 1 OF 2</b>





ON Semiconductor and  are trademarks of Semiconductor Components Industries, LLC dba ON Semiconductor or its subsidiaries in the United States and/or other countries. ON Semiconductor owns the rights to a number of patents, trademarks, copyrights, trade secrets, and other intellectual property. A listing of ON Semiconductor's product/patent coverage may be accessed at [www.onsemi.com/site/pdf/Patent-Marking.pdf](http://www.onsemi.com/site/pdf/Patent-Marking.pdf). ON Semiconductor reserves the right to make changes without further notice to any products herein. ON Semiconductor makes no warranty, representation or guarantee regarding the suitability of its products for any particular purpose, nor does ON Semiconductor assume any liability arising out of the application or use of any product or circuit, and specifically disclaims any and all liability, including without limitation special, consequential or incidental damages. Buyer is responsible for its products and applications using ON Semiconductor products, including compliance with all laws, regulations and safety requirements or standards, regardless of any support or applications information provided by ON Semiconductor. "Typical" parameters which may be provided in ON Semiconductor data sheets and/or specifications can and do vary in different applications and actual performance may vary over time. All operating parameters, including "Typicals" must be validated for each customer application by customer's technical experts. ON Semiconductor does not convey any license under its patent rights nor the rights of others. ON Semiconductor products are not designed, intended, or authorized for use as a critical component in life support systems or any FDA Class 3 medical devices or medical devices with a same or similar classification in a foreign jurisdiction or any devices intended for implantation in the human body. Should Buyer purchase or use ON Semiconductor products for any such unintended or unauthorized application, Buyer shall indemnify and hold ON Semiconductor and its officers, employees, subsidiaries, affiliates, and distributors harmless against all claims, costs, damages, and expenses, and reasonable attorney fees arising out of, directly or indirectly, any claim of personal injury or death associated with such unintended or unauthorized use, even if such claim alleges that ON Semiconductor was negligent regarding the design or manufacture of the part. ON Semiconductor is an Equal Opportunity/Affirmative Action Employer. This literature is subject to all applicable copyright laws and is not for resale in any manner.

## PUBLICATION ORDERING INFORMATION

### LITERATURE FULFILLMENT:

Literature Distribution Center for ON Semiconductor  
19521 E. 32nd Pkwy, Aurora, Colorado 80011 USA  
**Phone:** 303-675-2175 or 800-344-3860 Toll Free USA/Canada  
**Fax:** 303-675-2176 or 800-344-3867 Toll Free USA/Canada  
**Email:** [orderlit@onsemi.com](mailto:orderlit@onsemi.com)

**N. American Technical Support:** 800-282-9855 Toll Free  
USA/Canada  
**Europe, Middle East and Africa Technical Support:**  
Phone: 421 33 790 2910

**ON Semiconductor Website:** [www.onsemi.com](http://www.onsemi.com)

**Order Literature:** <http://www.onsemi.com/orderlit>

For additional information, please contact your local  
Sales Representative