



**THE DATASHEET OF
MMZ2012S181AT000**



Chip beads
For general signal line
MMZ series



MMZ2012 type



FEATURES

- Noise reduction solution for general signal line.
- Various frequency characteristics with 4 materials of different features for countermeasures against everything from general signals to high-speed signals.
- Operating temperature range: -55 to +125°C

APPLICATION

- Noise removal for mobile devices such as smartphones and tablet terminals, and various modules.
- Noise removal for PCs and recorders, household appliances such as STBs, smart grids, and industrial equipment.

PART NUMBER CONSTRUCTION

MMZ	2012	R	150	A	T	000
Series name	LxWxT dimensions 2.0x1.25x0.85 mm	Material name	Impedance (Ω) at 100MHz	Characteristic type	Packaging style	Internal code

CHARACTERISTICS SPECIFICATION TABLE

Impedance [100MHz] (Ω)	Tolerance	DC resistance (Ω)max.	Rated current (mA)max.	Part No.
15	±25%	0.05	1500	MMZ2012R150AT000
30	±25%	0.05	1500	MMZ2012R300AT000
60	±25%	0.10	1000	MMZ2012R600AT000
120	±25%	0.12	800	MMZ2012R121AT000
300	±25%	0.15	600	MMZ2012R301AT000
600	±25%	0.20	500	MMZ2012R601AT000
1000	±25%	0.30	500	MMZ2012R102AT000
40	±25%	0.10	1000	MMZ2012S400AT000
80	±25%	0.10	800	MMZ2012S800AT000
120	±25%	0.15	800	MMZ2012S121AT000
180	±25%	0.15	600	MMZ2012S181AT000
300	±25%	0.20	600	MMZ2012S301AT000
600	±25%	0.30	500	MMZ2012S601AT000
1000	±25%	0.35	500	MMZ2012S102AT000

Measurement equipment

Measurement item	Product No.	Manufacturer
Impedance	E4991A+16192A	Keysight Technologies
DC resistance	Type-7556	Yokogawa

* Equivalent measurement equipment may be used.

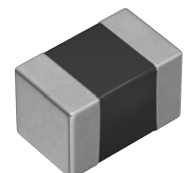

MMZ2012 type

CHARACTERISTICS SPECIFICATION TABLE

Impedance [100MHz] (Ω)		DC resistance (Ω)max.	Rated current (mA)max.	Part No.
	Tolerance			
15	$\pm 25\%$	0.05	1500	MMZ2012Y150BT000
30	$\pm 25\%$	0.05	1500	MMZ2012Y300BT000
60	$\pm 25\%$	0.10	1000	MMZ2012Y600BT000
120	$\pm 25\%$	0.12	800	MMZ2012Y121BT000
300	$\pm 25\%$	0.15	600	MMZ2012Y301BT000
600	$\pm 25\%$	0.20	500	MMZ2012Y601BT000
1000	$\pm 25\%$	0.30	500	MMZ2012Y102BT000
1500	$\pm 25\%$	0.40	500	MMZ2012Y152BT000
2000	$\pm 25\%$	0.50	400	MMZ2012Y202BT000
80	$\pm 25\%$	0.30	500	MMZ2012D800BT000
120	$\pm 25\%$	0.30	500	MMZ2012D121BT000
300	$\pm 25\%$	0.50	400	MMZ2012D301BT000

Measurement equipment

Measurement item	Product No.	Manufacturer
Impedance	E4991A+16192A	Keysight Technologies
DC resistance	Type-7556	Yokogawa

* Equivalent measurement equipment may be used.

MMZ2012 type

Z VS. FREQUENCY CHARACTERISTICS (BY SERIES)

MMZ2012R series

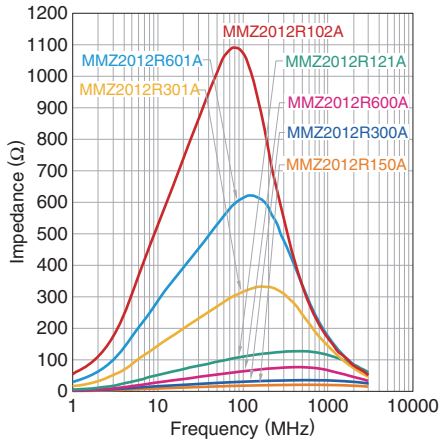

MMZ2012S series

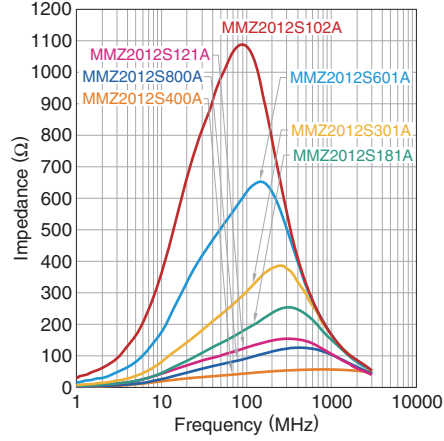

MMZ2012Y series

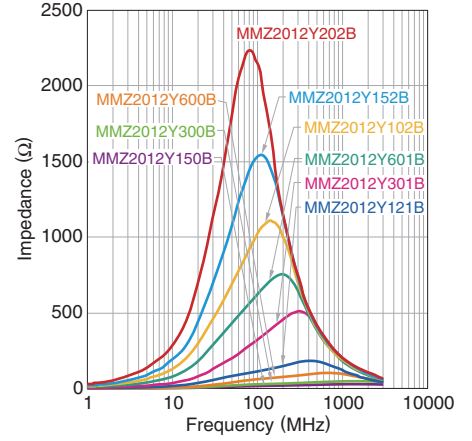

MMZ2012D series

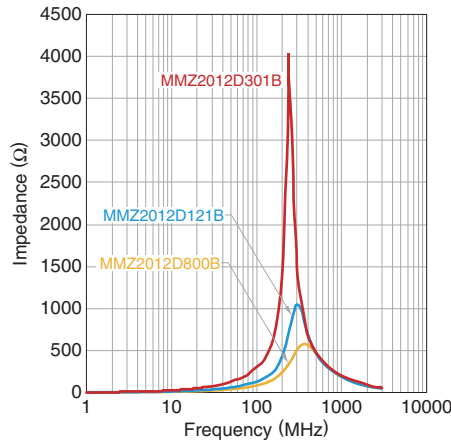

MMZ2012 type

Z, X, R VS. FREQUENCY CHARACTERISTICS

MMZ2012R150AT000

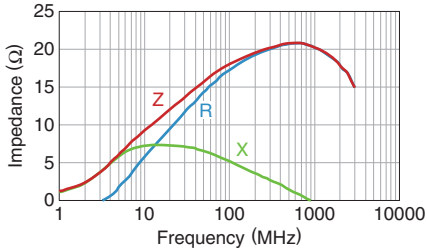

MMZ2012R300AT000

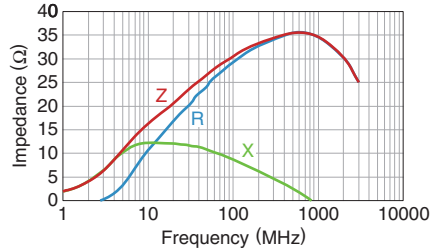

MMZ2012R600AT000

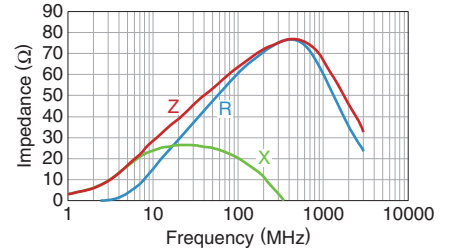

MMZ2012R121AT000

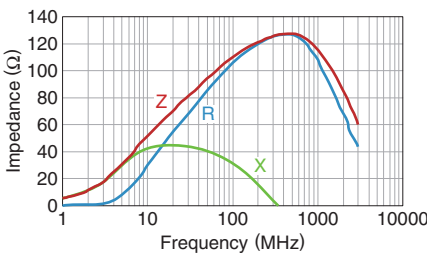

MMZ2012R301AT000

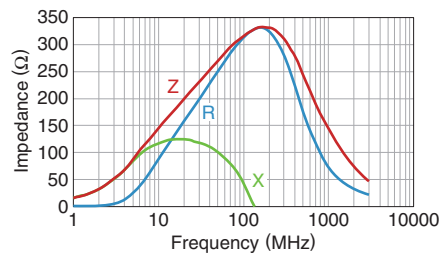

MMZ2012R601AT000

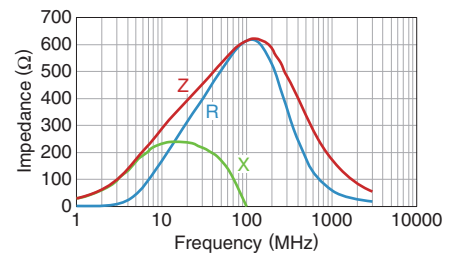

MMZ2012R102AT000

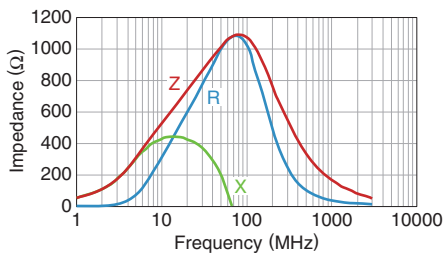

MMZ2012S400AT000

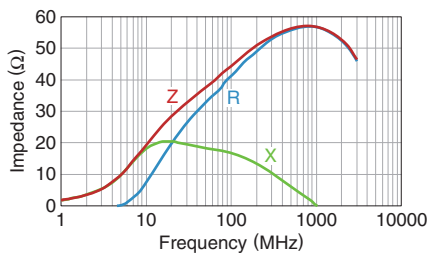

MMZ2012S800AT000

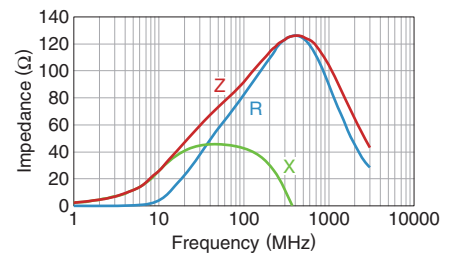

MMZ2012S121AT000

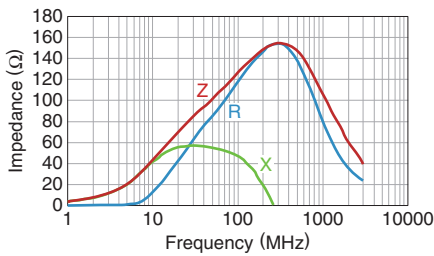

MMZ2012S181AT000

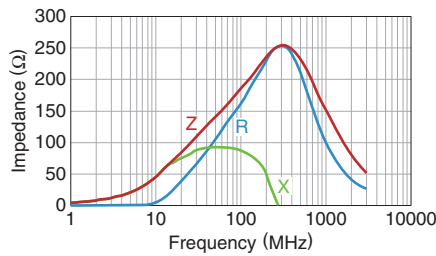

MMZ2012S301AT000

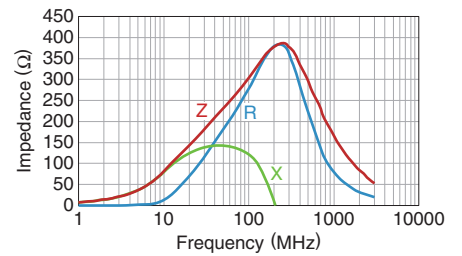

MMZ2012S601AT000

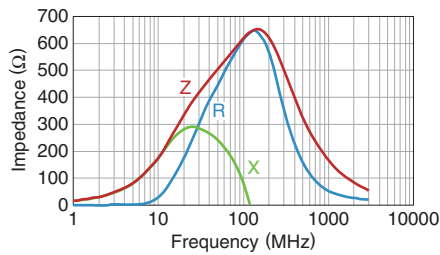

MMZ2012S102AT000

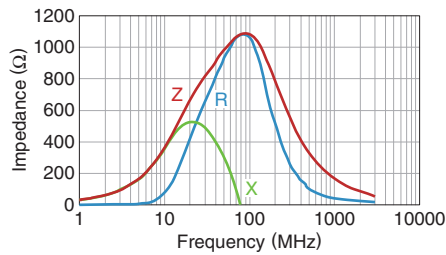

MMZ2012Y150BT000

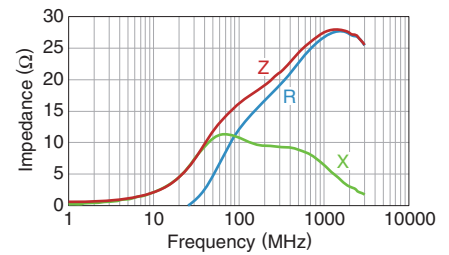

⚠ Please be sure to request delivery specifications that provide further details on the features and specifications of the products for proper and safe use. (4/7)
Please note that the contents may change without any prior notice due to reasons such as upgrading.

MMZ2012 type

Z, X, R VS. FREQUENCY CHARACTERISTICS

MMZ2012Y300BT000

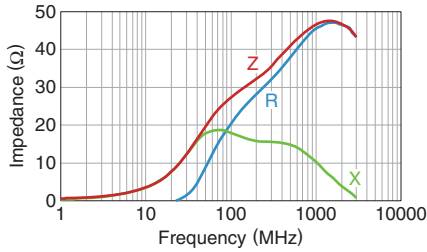

MMZ2012Y600BT000

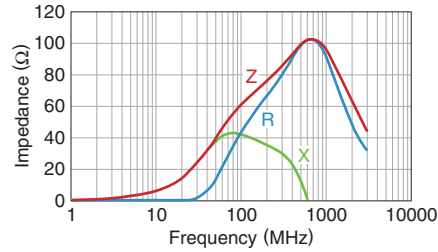

MMZ2012Y121BT000

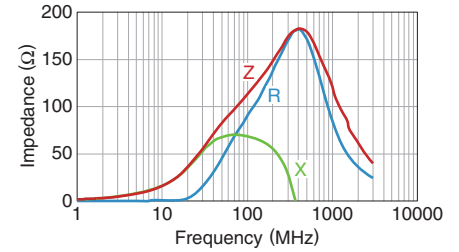

MMZ2012Y301BT000

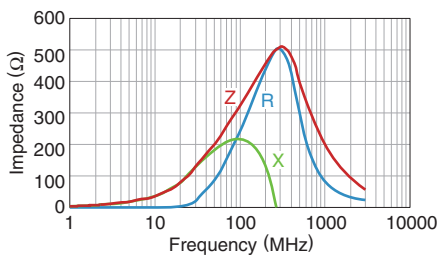

MMZ2012Y601BT000

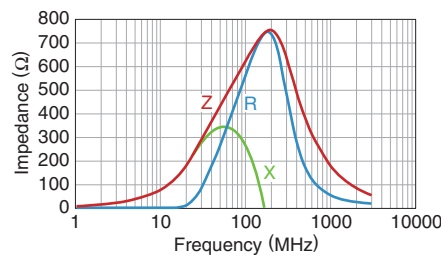

MMZ2012Y102BT000

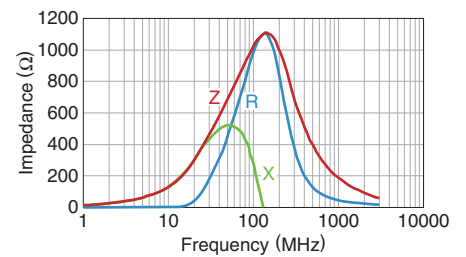

MMZ2012Y152BT000

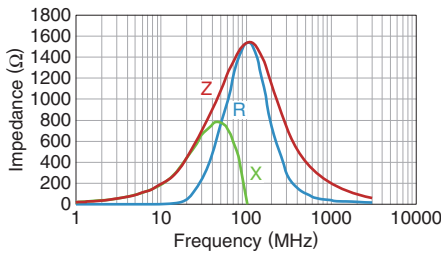

MMZ2012Y202BT000

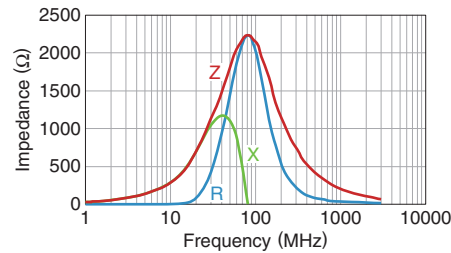

MMZ2012D800BT000

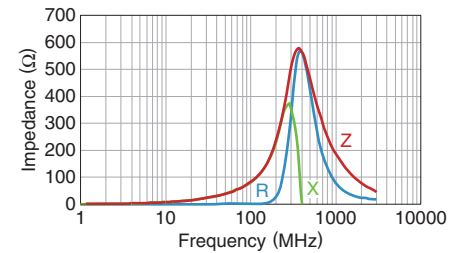

MMZ2012D121BT000

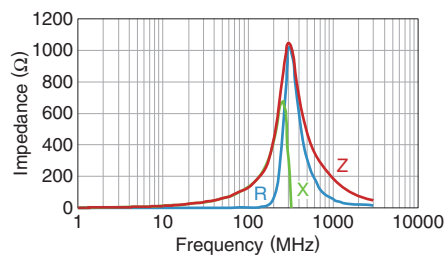

MMZ2012D301BT000

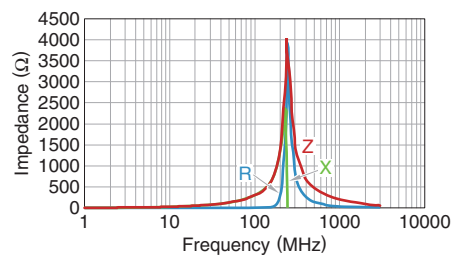

MMZ2012 type

SHAPE & DIMENSIONS

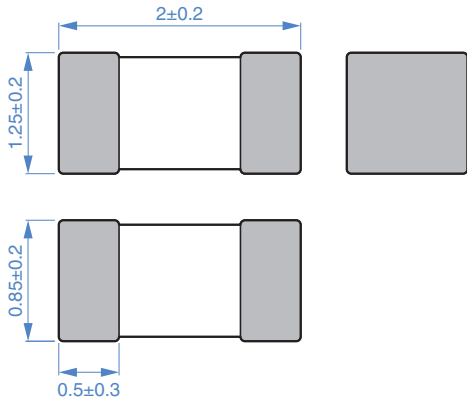

Dimensions in mm

PACKAGING STYLE

REEL DIMENSIONS

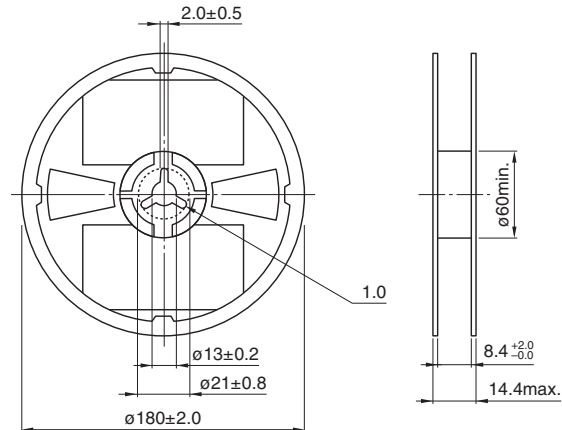

Dimensions in mm

RECOMMENDED LAND PATTERN

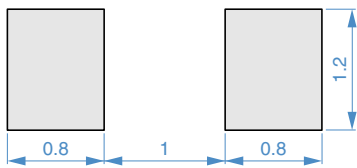

Dimensions in mm

TAPE DIMENSIONS

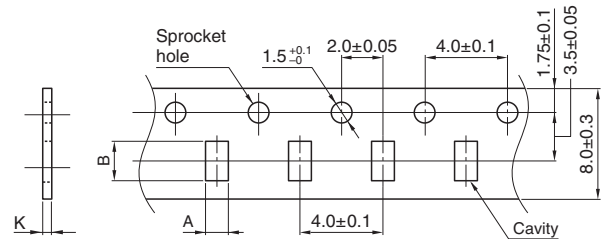

Dimensions in mm

Type	A	B	K
MMZ2012	1.5±0.2	2.3±0.2	1.1 max.

RECOMMENDED REFLOW PROFILE

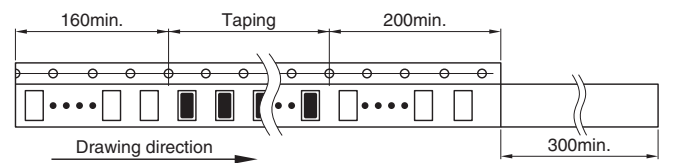
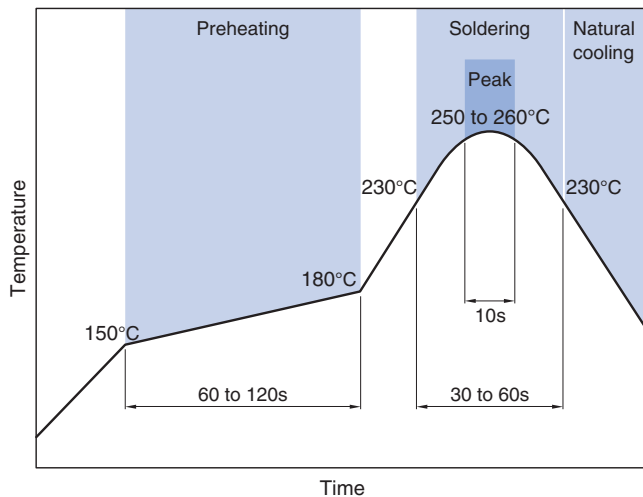

Dimensions in mm

PACKAGE QUANTITY

Package quantity	4,000 pcs/reel
------------------	----------------

TEMPERATURE RANGE, INDIVIDUAL WEIGHT

Operating temperature range	Storage temperature range*	Individual weight
-55 to +125°C	-55 to +125°C	8 mg

* The storage temperature range is for after the assembly.

REMINDERS FOR USING THESE PRODUCTS

Before using these products, be sure to request the delivery specifications.

SAFETY REMINDERS

Please pay sufficient attention to the warnings for safe designing when using this products.

REMINDERS

- The storage period is within 12 months. Be sure to follow the storage conditions (temperature: 5 to 40°C, humidity: 10 to 75% RH or less).
If the storage period elapses, the soldering of the terminal electrodes may deteriorate.
- Do not use or store in locations where there are conditions such as gas corrosion (salt, acid, alkali, etc.).
- Before soldering, be sure to preheat components.
The preheating temperature should be set so that the temperature difference between the solder temperature and chip temperature does not exceed 150°C.
- Soldering corrections after mounting should be within the range of the conditions determined in the specifications.
If overheated, a short circuit, performance deterioration, or lifespan shortening may occur.
- When embedding a printed circuit board where a chip is mounted to a set, be sure that residual stress is not given to the chip due to the overall distortion of the printed circuit board and partial distortion such as at screw tightening portions.
- Self heating (temperature increase) occurs when the power is turned ON, so the tolerance should be sufficient for the set thermal design.
- Carefully lay out the coil for the circuit board design of the non-magnetic shield type.
A malfunction may occur due to magnetic interference.
- Use a wrist band to discharge static electricity in your body through the grounding wire.
- Do not expose the products to magnets or magnetic fields.
- Do not use for a purpose outside of the contents regulated in the delivery specifications.
- The products listed on this catalog are intended for use in general electronic equipment (AV equipment, telecommunications equipment, home appliances, amusement equipment, computer equipment, personal equipment, office equipment, measurement equipment, industrial robots) under a normal operation and use condition.
The products are not designed or warranted to meet the requirements of the applications listed below, whose performance and/or quality require a more stringent level of safety or reliability, or whose failure, malfunction or trouble could cause serious damage to society, person or property.
If you intend to use the products in the applications listed below or if you have special requirements exceeding the range or conditions set forth in the each catalog, please contact us.

- (1) Aerospace/aviation equipment
- (2) Transportation equipment (cars, electric trains, ships, etc.)
- (3) Medical equipment
- (4) Power-generation control equipment
- (5) Atomic energy-related equipment
- (6) Seabed equipment
- (7) Transportation control equipment

- (8) Public information-processing equipment
- (9) Military equipment
- (10) Electric heating apparatus, burning equipment
- (11) Disaster prevention/crime prevention equipment
- (12) Safety equipment
- (13) Other applications that are not considered general-purpose applications

When designing your equipment even for general-purpose applications, you are kindly requested to take into consideration securing protection circuit/device or providing backup circuits in your equipment.