



**THE DATASHEET OF
B0922N7575AHF**



Xinger®

Ultra Low Profile 0404 Balun 75Ω to 75Ω Balanced

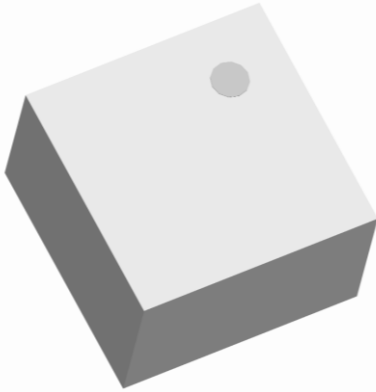

Description

The B0922N7575AHF is a low profile, low impedance 1mm square sub-miniature wideband unbalanced to balanced transformer designed for differential inputs and output locations on modern chipsets targeted at a wide variety of markets where 900MHz to 2200MHz band coverage is required all in an easy to use surface mount package. The B0922N7575AHF is ideal for high volume manufacturing and delivers high repeatable performance against traditional baluns. The B0922N7575AHF has an unbalanced port impedance of 75Ω and a 75Ω balanced port impedance. The output ports have equal amplitude (-3dB) with 180 degree phase differential. The B0922N7575AHF is available on tape and reel for pick and place high volume manufacturing.

Detailed Electrical Specifications: Specifications subject to change without notice.

Features:	Parameter	ROOM (25°C)			Unit
		Min.	Typ.	Max	
<ul style="list-style-type: none"> • 950 – 2150 MHz • 0.64 mm Height Profile • 75 Ohm to 2 x 37.5 Ohm • Low Insertion Loss • Class Leading CMRR • Primarily Targeted at DVB-S Applications • Surface Mountable • Tape & Reel • Non-conductive Top Surface • RoHS Compliant • Halogen Free 	Frequency	950		2150	MHz
	Unbalanced Port Impedance		75		Ω
	Balanced Port Impedance		75		Ω
	Return Loss	13.2	17.2		dB
	Insertion Loss*		0.55	0.76	dB
	Amplitude Balance**		1.81	2.1	dB
	Phase Balance**		18.39	20.95	Degrees
	CMRR**	12.6	14.3		dB
	Power Handling			0.75	Watts
	Operating Temperature	-55		+85	°C

* Insertion Loss stated at room temperature (Insertion Loss is approximately 0.1 dB higher at +85 °C)

** Performance can be improved using an outside inductor shown in page 3

Outline Drawing

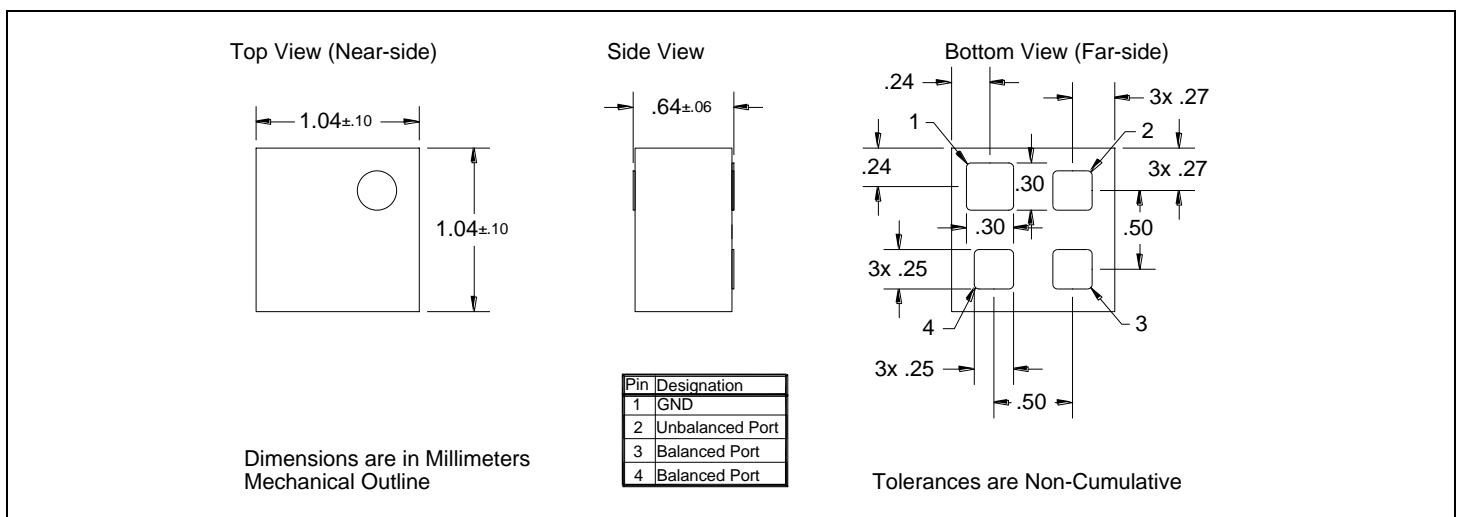

Typical Performance: 900 MHz. to 2200 MHz.

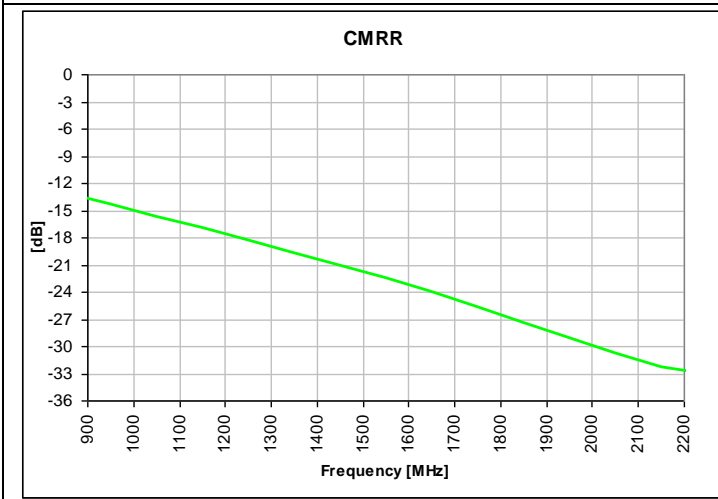
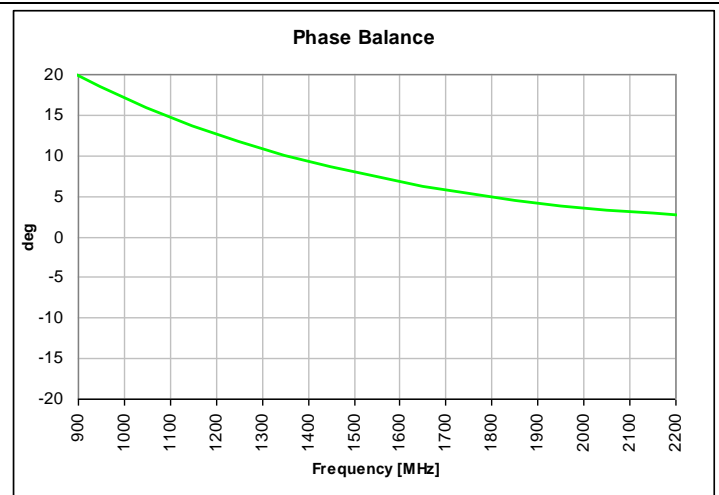
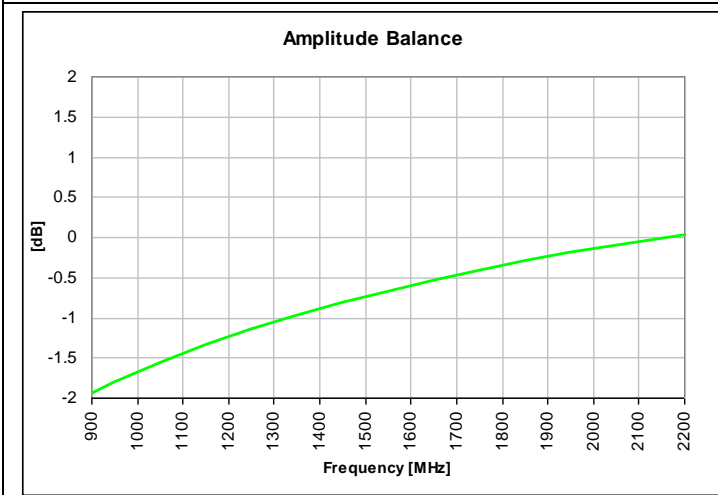
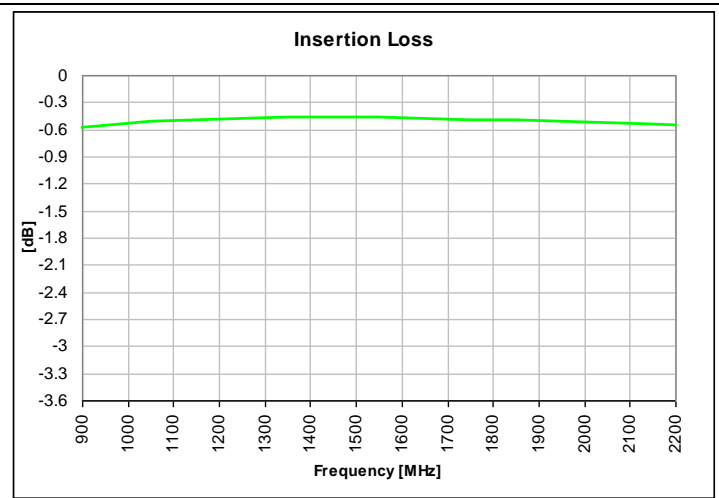
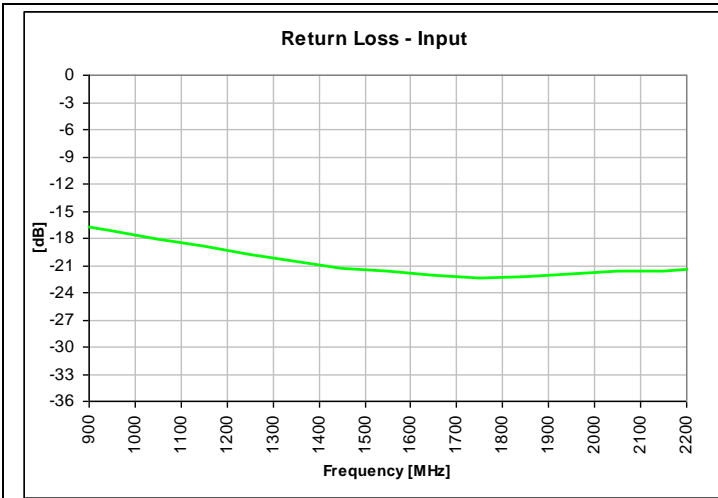

Typical Performance (Ruthroff configuration using an external 16 nH Inductor)

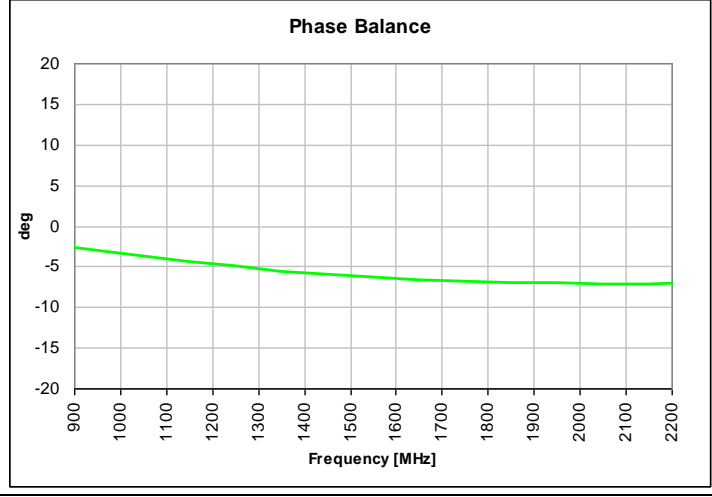
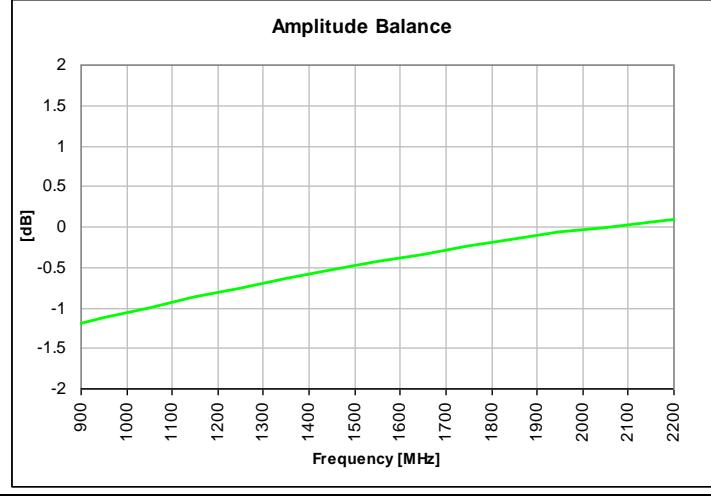
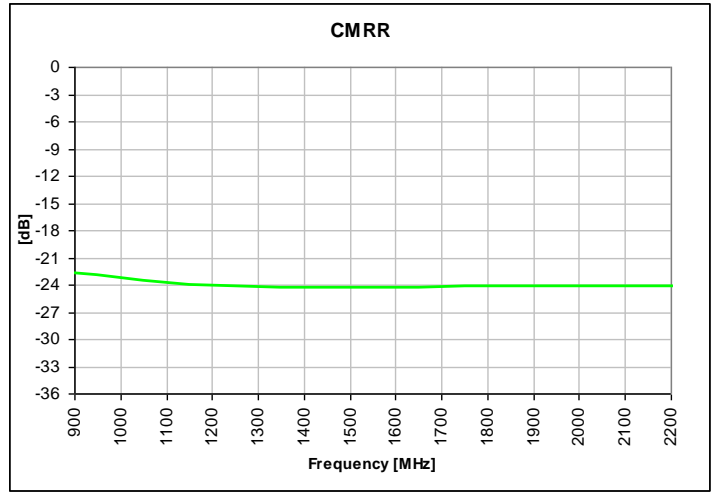
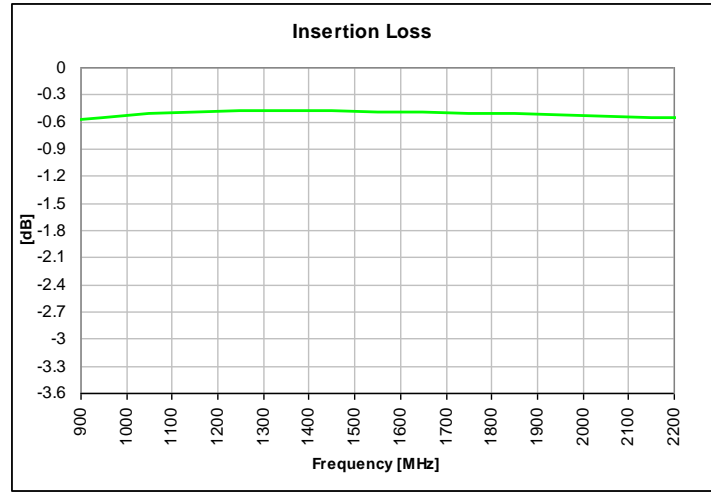
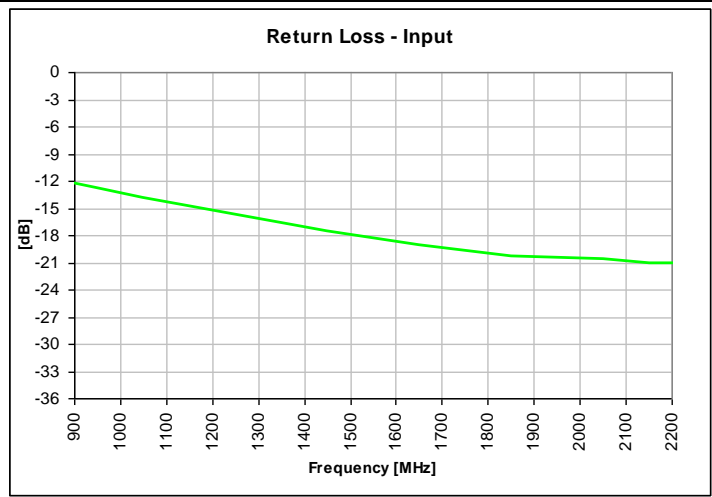
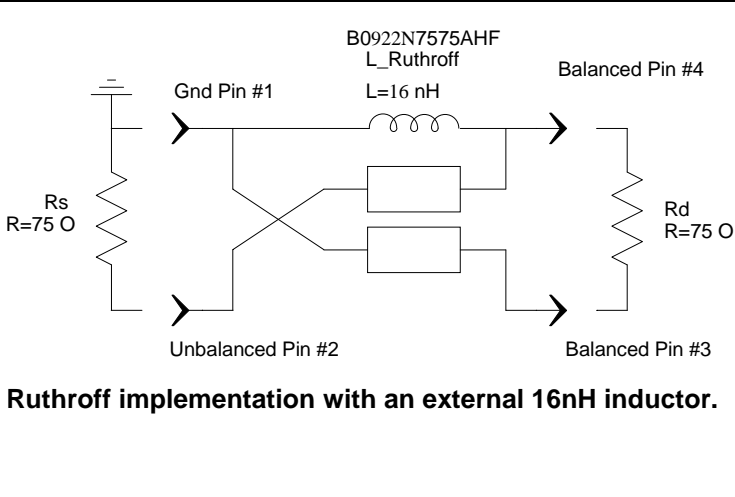

Wide Band Performance: 500 MHz. to 8500 MHz.

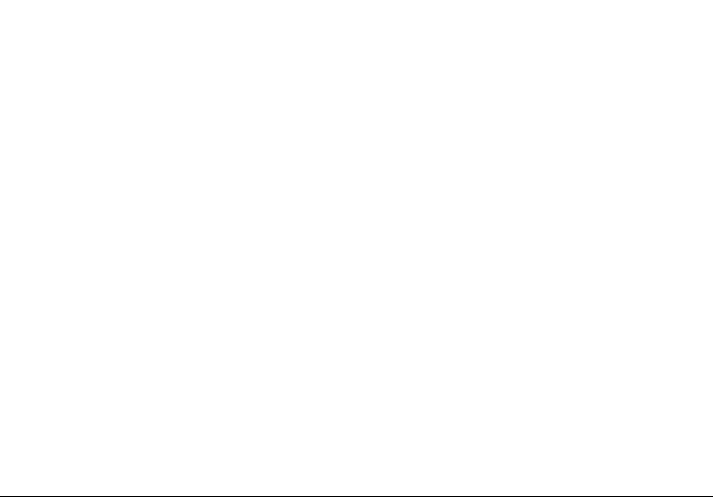
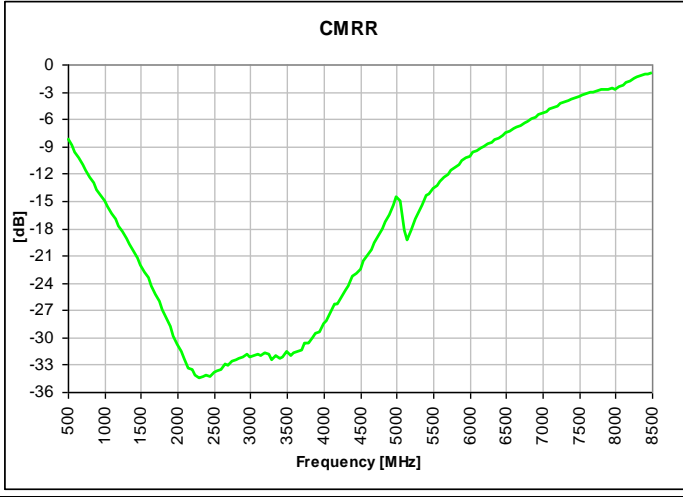
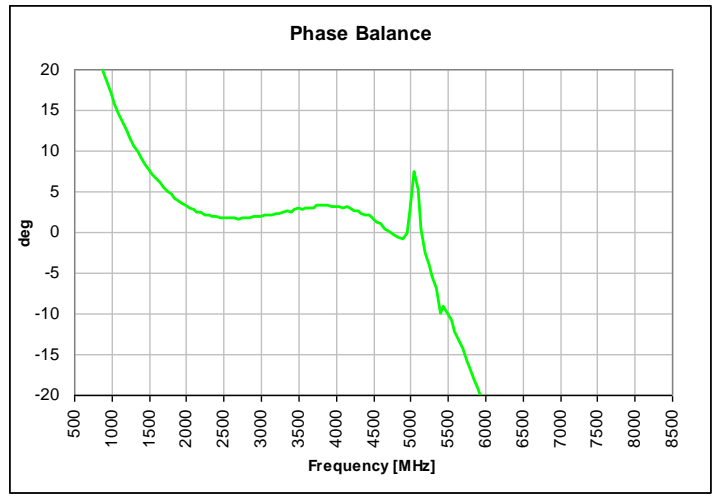
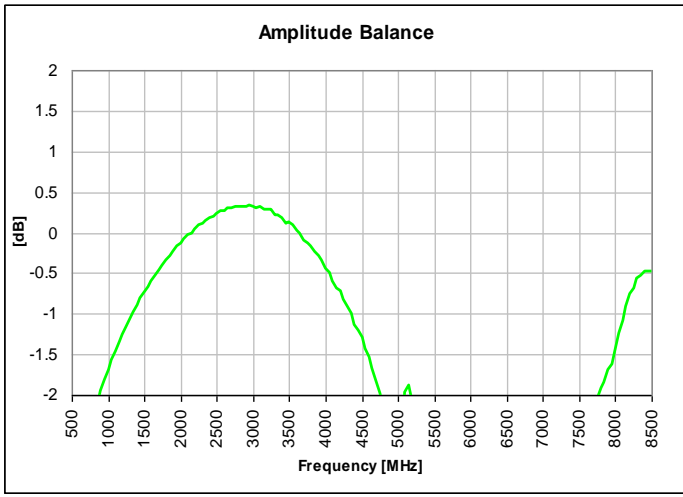
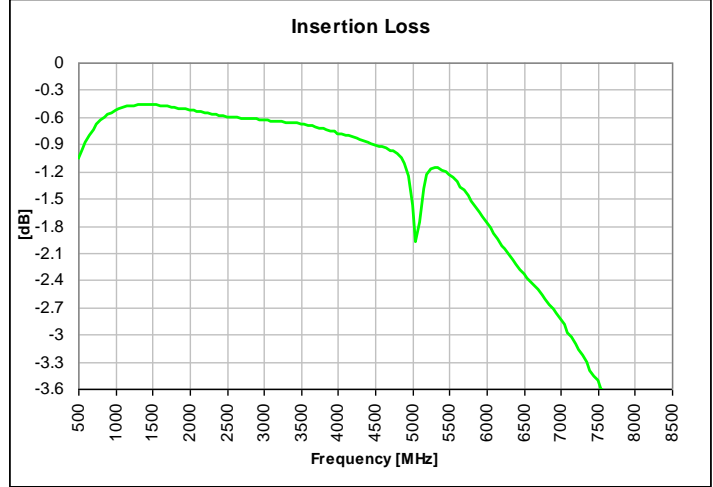
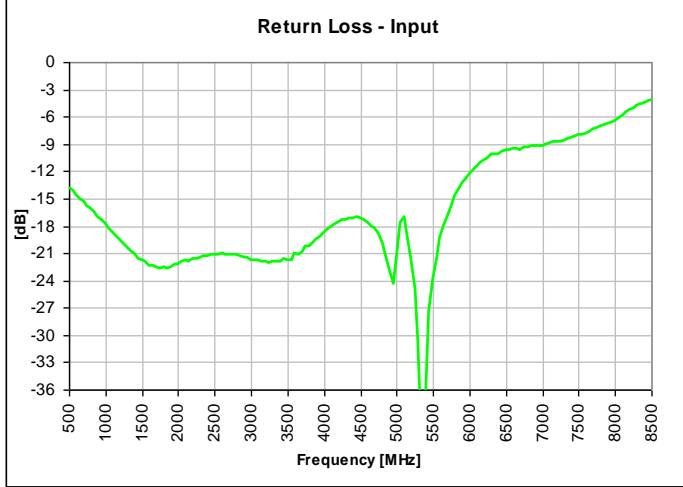

Mounting Configuration:

In order for Xinger surface mount components to work optimally, the proper impedance transmission lines must be used to connect to the RF ports. If this condition is not satisfied, insertion loss, Isolation and VSWR may not meet published specifications.

All of the Xinger components are constructed from organic PTFE based composites which possess excellent electrical and mechanical stability. Xinger components are compliant to a variety of ROHS and Green standards and ready for Pb-free soldering processes. Pads are Gold plated with a Nickel barrier.

An example of the PCB footprint used in the testing of these parts is shown below. An example of a DC-biased footprint is also shown below. In specific designs, the transmission line widths need to be adjusted to the unique dielectric coefficients and thicknesses as well as varying pick and place equipment tolerances.

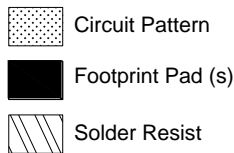
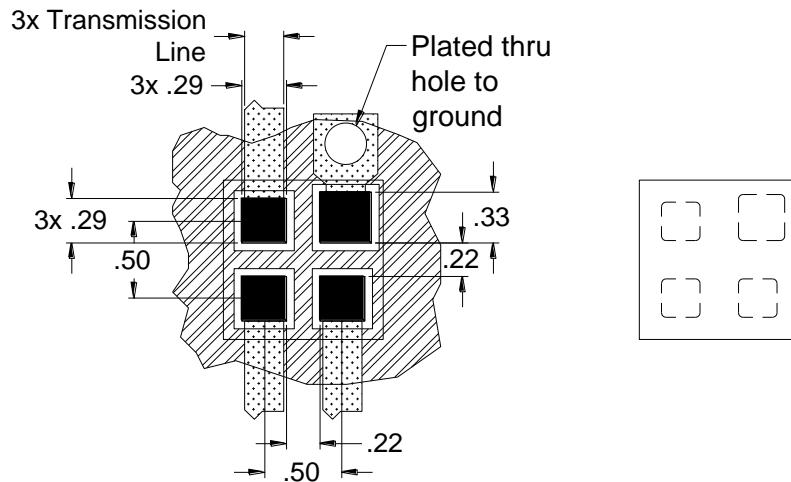

Dimensions are in Millimeters
Mounting Footprint

Packaging and Ordering Information

Parts are available in reel and are packaged per EIA 481-D. Parts are oriented in tape and reel as shown below. Minimum order quantities are 4000 per reel.

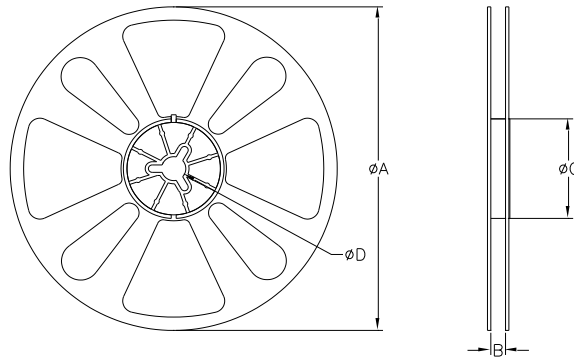
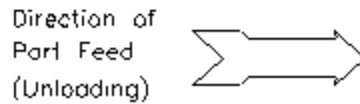
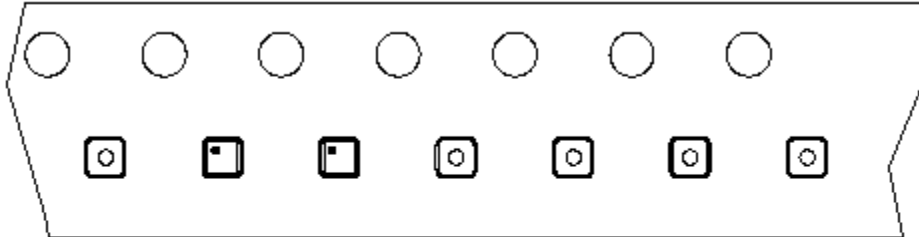

TABLE 1		
QUANTITY/REEL	REEL DIMENSIONS mm	
4000	phi A	177.80
	B	8.00
	phi C	50.80
	phi D	13.00