



**THE DATASHEET OF
BZT55C2V7 LOG**



Small Signal Product

5% Tolerance SMD Zener Diode

FEATURES

- Wide zener voltage range selection: 2.4V to 75V
- VZ Tolerance Selection of $\pm 5\%$
- Moisture sensitivity level 1
- Matte Tin(Sn) lead finish with Nickel(Ni) underplate
- Pb free and RoHS compliant
- All external surfaces are corrosion resistant ; leads are readily solderable

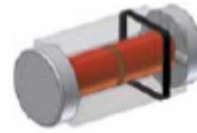

QUADRO Mini-MELF (LS34)

Hermetically Sealed Glass

MECHANICAL DATA

- Case: QUADRO Mini-MELF Package (JEDEC DO-213)
- High temperature soldering guaranteed: 270°C/10s
- Polarity: Indicated by cathode band
- Weight: 29 \pm 2.5mg

MAXIMUM RATINGS AND ELECTRICAL CHARACTERISTICS (T _A =25°C unless otherwise noted)			
PARAMETER	SYMBOL	VALUE	UNIT
Power Dissipation	P _D	500	mW
Forward Voltage I _F = 10 mA	V _F	1	V
Thermal Resistance (Junction to Ambient) (Note 1)	R _{θJA}	500	°C/W
Junction and Storage Temperature Range	T _J , T _{STG}	- 65 to +175	°C

Note1: Valid provided that electrodes are kept at ambient temperature

Zener I vs. V Characteristics

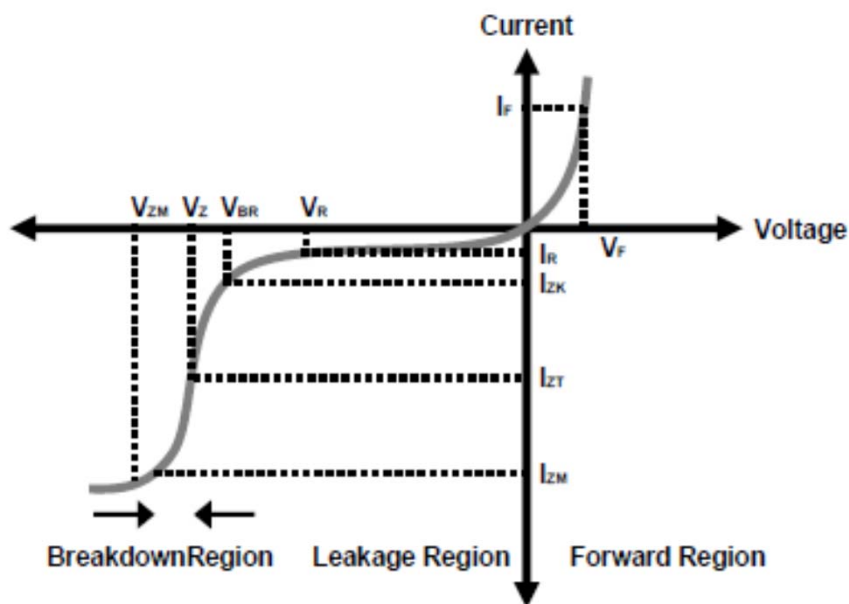

- V_{BR} : Voltage at I_{ZK}
- I_{ZK} : Test current for voltage V_{BR}
- Z_{ZK} : Dynamic impedance at I_{ZK}
- I_{ZT} : Test current for voltage V_Z
- V_Z : Voltage at current I_{ZT}
- Z_{ZT} : Dynamic impedance at I_{ZT}
- I_{ZM} : Maximum steady state current
- V_{ZM} : Voltage at I_{ZM}

Small Signal

 ELECTRICAL CHARACTERISTICS ($T_A = 25^\circ\text{C}$ unless otherwise noted)

Part Number	$V_Z @ I_{ZT}$ (Volt)			I_{ZT} (mA)	$Z_{ZT} @ I_{ZT}$ (Ω) Max	I_{ZK} (mA)	$Z_{ZK} @ I_{ZK}$ (Ω) Max	$I_R @ V_R$ (μA) Max	V_R (V)
	Nom	Min	Max						
BZT55C2V4	2.4	2.28	2.56	5	85	1	600	50	1
BZT55C2V7	2.7	2.51	2.89	5	85	1	600	10	1
BZT55C3V0	3.0	2.8	3.2	5	85	1	600	4	1
BZT55C3V3	3.3	3.1	3.5	5	85	1	600	2	1
BZT55C3V6	3.6	3.4	3.8	5	85	1	600	2	1
BZT55C3V9	3.9	3.7	4.1	5	85	1	600	2	1
BZT55C4V3	4.3	4.0	4.6	5	75	1	600	1	1
BZT55C4V7	4.7	4.4	5.0	5	60	1	600	0.5	1
BZT55C5V1	5.1	4.8	5.4	5	35	1	550	0.1	1
BZT55C5V6	5.6	5.2	6.0	5	25	1	450	0.1	1
BZT55C6V2	6.2	5.8	6.6	5	10	1	200	0.1	2
BZT55C6V8	6.8	6.4	7.2	5	8	1	150	0.1	3
BZT55C7V5	7.5	7.0	7.9	5	7	1	50	0.1	5
BZT55C8V2	8.2	7.7	8.7	5	7	1	50	0.1	6.2
BZT55C9V1	9.1	8.5	9.6	5	10	1	50	0.1	6.8
BZT55C10	10	9.4	10.6	5	15	1	70	0.1	7.5
BZT55C11	11	10.4	11.6	5	20	1	70	0.1	8.2
BZT55C12	12	11.4	12.7	5	20	1	90	0.1	9.1
BZT55C13	13	12.4	14.1	5	26	1	110	0.1	10
BZT55C15	15	13.8	15.6	5	30	1	110	0.1	11
BZT55C16	16	15.3	17.1	5	40	1	170	0.1	12
BZT55C18	18	16.8	19.1	5	50	1	170	0.1	13
BZT55C20	20	18.8	21.1	5	55	1	220	0.1	15
BZT55C22	22	20.8	23.3	5	55	1	220	0.1	16
BZT55C24	24	22.8	25.6	5	80	1	220	0.1	18
BZT55C27	27	25.1	28.9	5	80	1	220	0.1	20
BZT55C30	30	28	32	5	80	1	220	0.1	22
BZT55C33	33	31	35	5	80	1	220	0.1	24
BZT55C36	36	34	38	5	80	1	220	0.1	27
BZT55C39	39	37	41	2.5	90	0.5	500	0.1	28
BZT55C43	43	40	46	2.5	90	0.5	600	0.1	32
BZT55C47	47	44	50	2.5	110	0.5	700	0.1	35
BZT55C51	51	48	54	2.5	125	0.5	700	0.1	38
BZT55C56	56	52	60	2.5	135	0.5	1,000	0.1	42
BZT55C62	62	58	66	2.5	150	0.5	1,000	0.1	47
BZT55C68	68	64	72	2.5	160	0.5	1,000	0.1	51
BZT55C75	75	70	79	2.5	170	0.5	1,000	0.1	56

Notes : 1. The Zener Voltage (V_Z) is tested under pulse condition of 10ms.

2. The device numbers listed have a standard tolerance on the nominal zener voltage of $\pm 5\%$.

3. For detailed information on price, availability and delivery of nominal zener voltages between the voltages shown and tighter voltage tolerances, contact your nearest Taiwan Semiconductor representative.

4. The Zener impedance is derived from the 60-cycle ac voltage, which results when an ac current having an RMS value equal to 10% of the dc zener current (I_{ZT} or I_{ZK}) is superimposed to I_{ZT} or I_{ZK} .

Small Signal Product

RATINGS AND CHARACTERISTICS CURVES

(TA=25°C unless otherwise noted)

Fig. 1 Typical Forward Characteristics

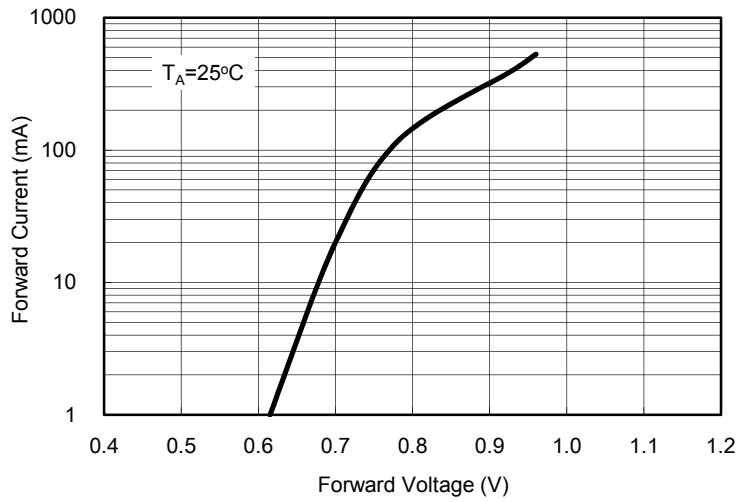

Fig. 2 Zener Breakdown Characteristics

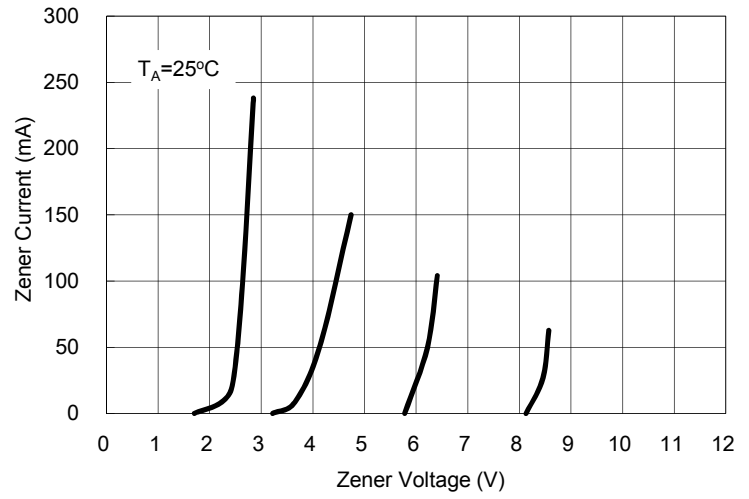

Fig. 3 Zener Breakdown Characteristics

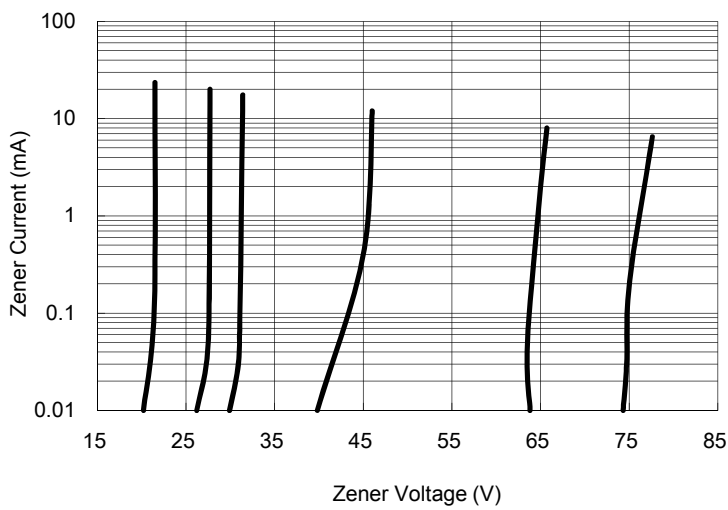

Fig. 4 Admissible Power Dissipation Curve

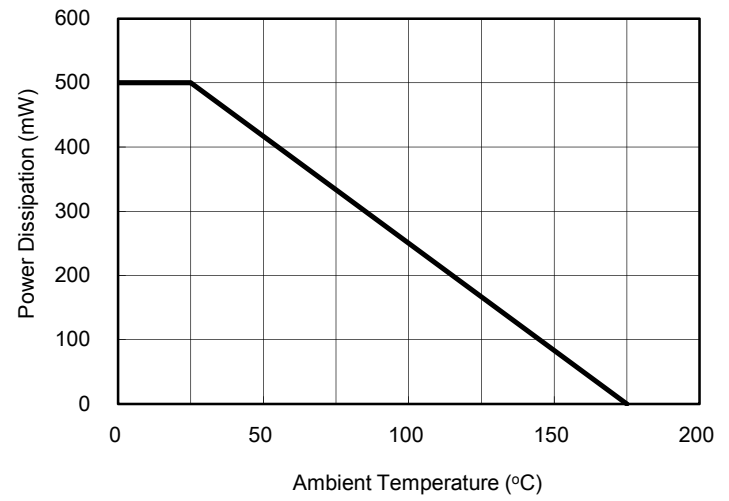

Fig. 5 Typical Capacitance

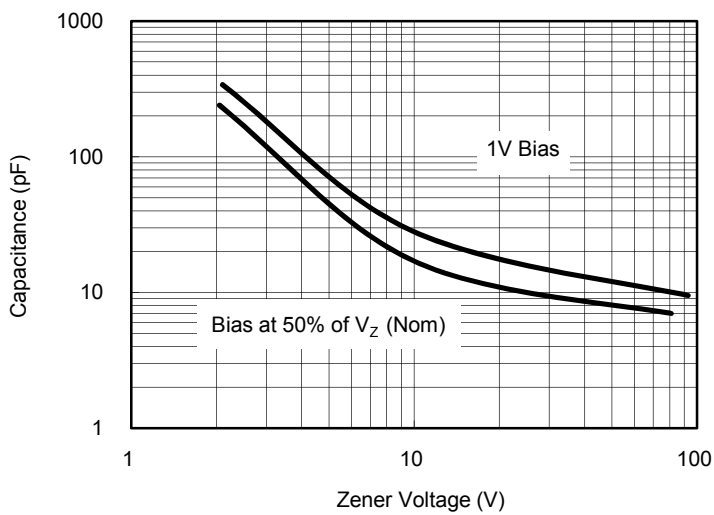
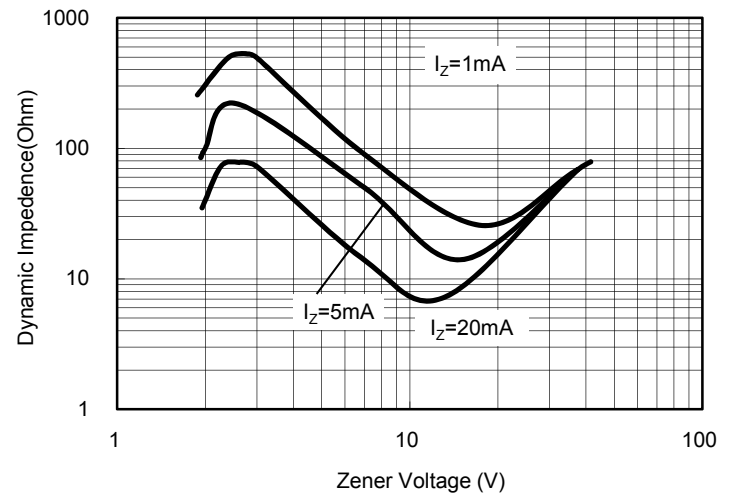

Fig. 6 Effect of Zener Voltage on Impedance



Small Signal Product

ORDERING INFORMATION

PART NO.	MANUFACTURE CODE	PACKING CODE	GREEN COMPOUND CODE	PACKAGE	PACKING
BZT55Cxxx (Note1)	(Note 2)	L0	G	Quadro Mini-MELF (Glass Seal)	10K / 13" Reel
		L1		Quadro Mini-MELF (Glass Seal)	2.5K / 7" Reel

Note 1: "xxx" defines voltage from 2.4V (BZT55C2V4) to 75V (BZT55C75)

Note 2: Manufacture special control, if empty means no special control requirement.

EXAMPLE

PREFERRED P/N	PART NO.	MANUFACTURE CODE	PACKING CODE	GREEN COMPOUND CODE	DESCRIPTION
BZT55C75 L0G	BZT55C75		L0	G	Green compound
BZT55C75-L0 L0G	BZT55C75	L0	L0	G	Green compound
BZT55C75-B0 L0G	BZT55C75	B0	L0	G	Green compound

PACKAGE OUTLINE DIMENSION

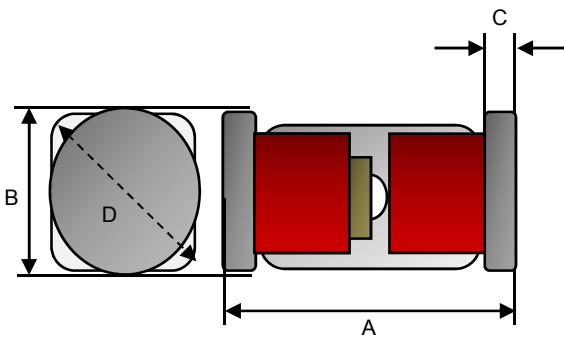

DIM.	Unit (mm)		Unit (inch)	
	Min	Max	Min	Max
A	3.30	3.70	0.130	0.146
B	1.40	1.60	0.055	0.063
C	0.20	0.45	0.008	0.018
D	1.8 TYP.		0.071 TYP.	

SUGGEST PAD LAYOUT

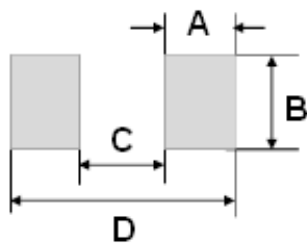

DIM.	Unit (mm)	Unit (inch)
	Typ.	Typ.
A	1.25	0.049
B	2.00	0.079
C	2.50	0.098
D	5.00	0.197

Notice

Specifications of the products displayed herein are subject to change without notice. TSC or anyone on its behalf, assumes no responsibility or liability for any errors inaccuracies.

Information contained herein is intended to provide a product description only. No license, express or implied, to any intellectual property rights is granted by this document. Except as provided in TSC's terms and conditions of sale for such products, TSC assumes no liability whatsoever, and disclaims any express or implied warranty, relating to sale and/or use of TSC products including liability or warranties relating to fitness for a particular purpose, merchantability, or infringement of any patent, copyright, or other intellectual property right.

The products shown herein are not designed for use in medical, life-saving, or life-sustaining applications. Customers using or selling these products for use in such applications do so at their own risk and agree to fully indemnify TSC for any damages resulting from such improper use or sale.