

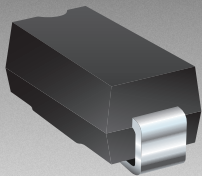

**THE DATASHEET OF  
CD214B-F2100**



\*RoHS COMPLIANT



**BOURNS®**

## Features

- RoHS compliant\*
- Glass passivated chip
- Low reverse leakage current
- Low forward voltage drop
- High current capability



This series is currently available but not recommended for new designs. The [Model CD214B-FS2x Series](#) is the recommended replacement.

## CD214B-F250~F2600 Surface Mount Fast Response Rectifiers

### General Information

The markets of portable communications, computing and video equipment are challenging the semiconductor industry to develop increasingly smaller electronic components. Bourns offers Surface Mount Fast Response Rectifiers for rectification applications, in compact chip DO-214AA (SMB) size format, which offer PCB real estate savings and are considerably smaller than most competitive parts. The Fast Response Rectifier Diodes offer a forward current of 2.0 A with a choice of repetitive peak reverse voltages of 50 V up to 600 V.

Bourns® Chip Diodes conform to JEDEC standards, are easy to handle on standard pick and place equipment and their flat configuration minimizes roll away.

### Electrical Characteristics (@ T<sub>A</sub> = 25 °C Unless Otherwise Noted)

Parameter	Symbol	CD214B-						Unit
		F250	F2100	F2150	F2200	F2400	F2600	
Maximum Repetitive Peak Reverse Voltage	V <sub>RRM</sub>	50	100	150	200	400	600	V
Maximum RMS Voltage	V <sub>RMS</sub>	35	70	105	140	280	420	V
Maximum DC Blocking Voltage	V <sub>DC</sub>	50	100	150	200	400	600	V
Max. Average Forward Rectified Current <sup>1</sup>	I <sub>(AV)</sub>	2.0						A
DC Reverse Current @ Rated DC Blocking Voltage (@ T <sub>J</sub> = 25 °C)	I <sub>R</sub>	5.0						μA
DC Reverse Current @ Rated DC Blocking Voltage (@ T <sub>J</sub> = 125 °C)	I <sub>R</sub>	350						μA
Typical Junction Capacitance <sup>2</sup>	C <sub>J</sub>	200						pF
Maximum Instantaneous Forward Voltage @ 1 A	V <sub>F</sub>	0.92			1.25	1.30		V
Typical Thermal Resistance <sup>3</sup>	R <sub>θJL</sub>	15						°C/W
Peak forward surge current 8.3 ms single half sine-wave superimposed on rated load (JEDEC Method)	I <sub>FSM</sub>	50						A

Notes:

1 See Figure 1.

2 Measured @ 1.0 MHz and applied reverse voltage of 4.0 VDC.

3 Thermal resistance from junction to ambient and from junction to lead P.C.B. mounted on 0.2" x 0.2" (5.0 mm x 5.0 mm) copper pad areas.

### Thermal Characteristics (@ T<sub>A</sub> = 25 °C Unless Otherwise Noted)

Parameter	Symbol	CD214B-F250-F2600	Unit
Operating Temperature Range	T <sub>J</sub>	-55 to +125	°C
Storage Temperature Range	T <sub>STG</sub>	-55 to +150	°C

\*RoHS Directive 2002/95/EC Jan. 27, 2003 including annex and RoHS Recast 2011/65/EU June 8, 2011.

Specifications are subject to change without notice.

The device characteristics and parameters in this data sheet can and do vary in different applications and actual device performance may vary over time. Users should verify actual device performance in their specific applications.

# CD214B-F250~F2600 Surface Mount Fast Response Rectifiers



## Product Dimensions

This is an RoHS compliant product. It is a molded plastic package. A cathode band indicates the polarity. The package weighs approximately 0.064 g. The package and dimensions are shown below.

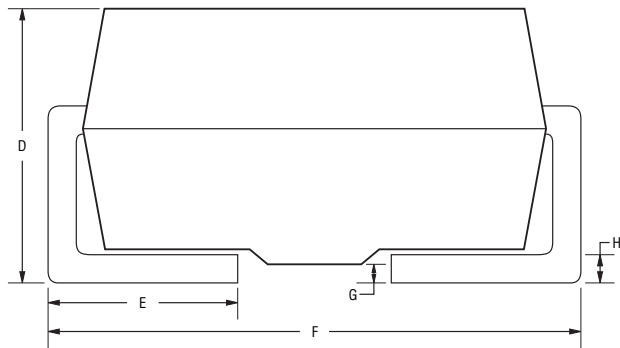
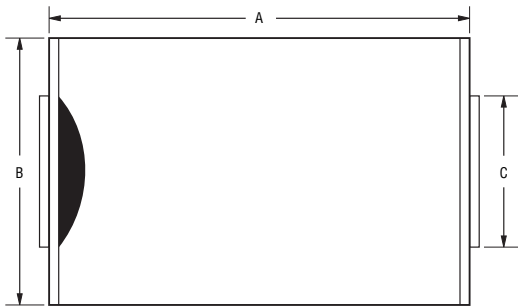

Dimensions	
A	$\frac{4.06 - 4.57}{(0.167 - 0.187)}$
B	$\frac{3.30 - 3.94}{(0.130 - 0.150)}$
C	$\frac{1.96 - 2.21}{(0.075 - 0.087)}$
D	$\frac{2.01 - 2.62}{(0.079 - 0.096)}$
E	$\frac{0.76 - 1.52}{(0.039 - 0.055)}$
F	$\frac{5.21 - 5.59}{(0.197 - 0.236)}$
G	$\frac{0.05 - 0.20}{(0.00196 - 0.00787)}$
H	$\frac{0.15 - 0.31}{(0.006 - 0.016)}$

DIMENSIONS:  $\frac{\text{MM}}{\text{(INCHES)}}$

## Recommended Pad Layout

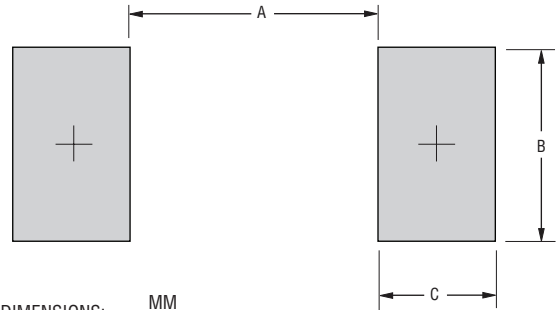

DIMENSIONS:  $\frac{\text{MM}}{\text{(INCHES)}}$

Dimension	SMA (DO-214AC)
A	$\frac{2.90}{(0.114)}$
B	$\frac{3.00}{(0.118)}$
C	$\frac{2.30}{(0.091)}$

## How To Order

**CD 214B - F 2 50**

Common Code \_\_\_\_\_  
 Chip Diode \_\_\_\_\_  
 Package \_\_\_\_\_  
 • 214B = SMB/DO-214AA  
 Model \_\_\_\_\_  
 F = Fast Response Rectifiers  
 Forward Current  $I_{AV}$  \_\_\_\_\_  
 2 = 2 A  
 Reverse Voltage \_\_\_\_\_  
 50 = 50 V  
 100 = 100 V  
 150 = 150 V  
 200 = 200 V  
 400 = 400 V  
 600 = 600 V

Specifications are subject to change without notice. The device characteristics and parameters in this data sheet can and do vary in different applications and actual device performance may vary over time. Users should verify actual device performance in their specific applications.

# CD214B-F250~F2600 Surface Mount Fast Response Rectifiers



## Rating and Characteristic Curves

### Forward Current Derating Curve

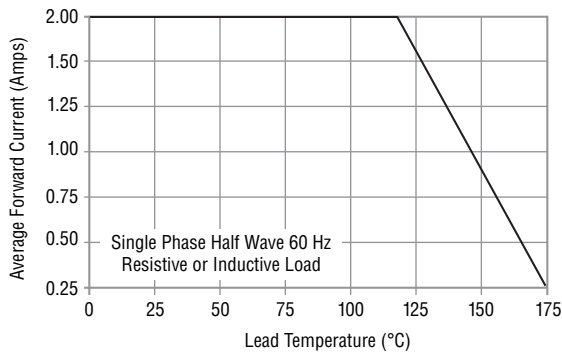

### Non-Repetitive Surge Current

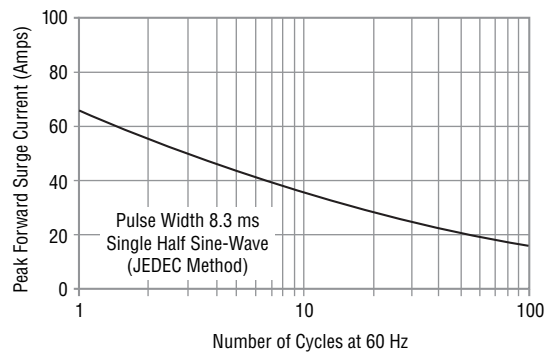

### Forward Characteristics

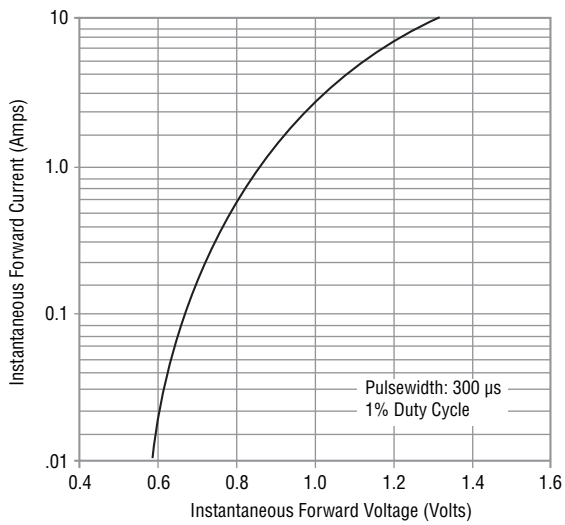

### Reverse Characteristics

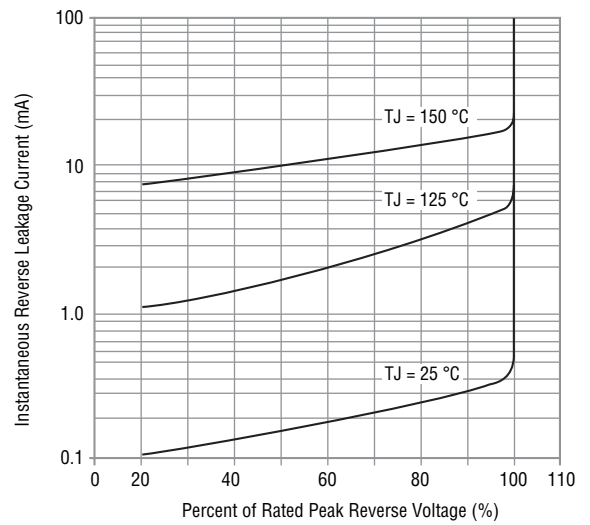

Specifications are subject to change without notice.  
The device characteristics and parameters in this data sheet can and do vary in different applications and actual device performance may vary over time.  
Users should verify actual device performance in their specific applications.

# CD214B-F250~F2600 Surface Mount Fast Response Rectifiers

**BOURNS®**

## Packaging Information

The surface mount product is packaged in an 8 mm x 4 mm tape and reel format per EIA-481 standard.

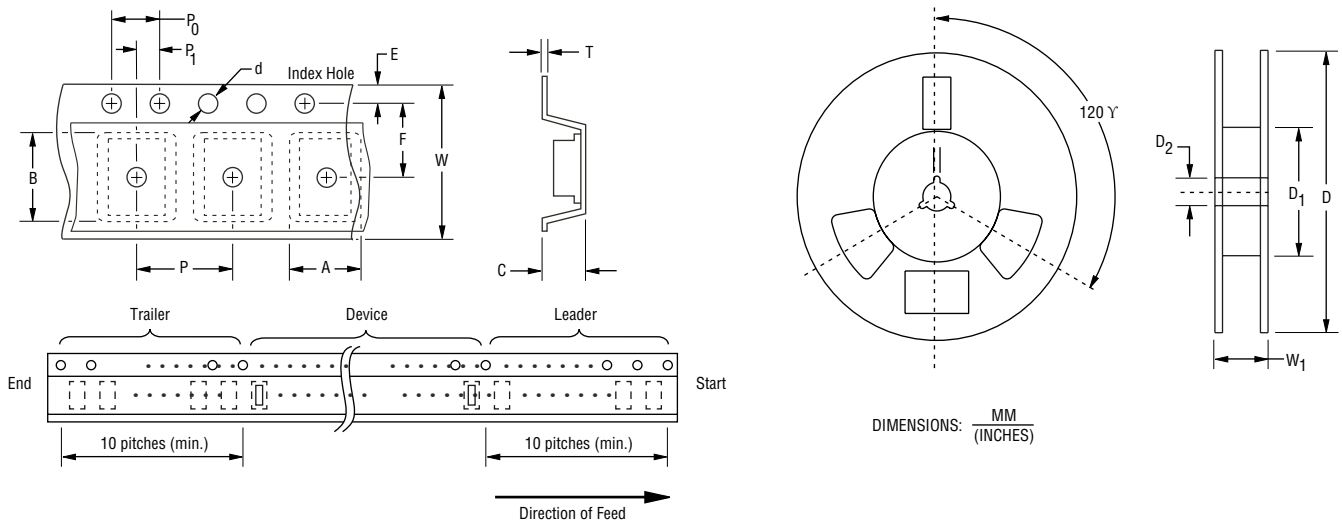

DIMENSIONS:  $\frac{\text{MM}}{\text{(INCHES)}}$

Item	Symbol	DO-214AA (SMB)
Carrier Width	A	$\frac{1.90 \pm 0.10}{(0.075 \pm 0.004)}$
Carrier Length	B	$\frac{4.30 \pm 0.10}{(0.169 \pm 0.004)}$
Carrier Depth	C	$\frac{1.80 \pm 0.10}{(0.071 \pm 0.004)}$
Sprocket Hole	d	$\frac{1.55 \pm 0.05}{(0.061 \pm 0.002)}$
Reel Outside Diameter	D	$\frac{178}{(7.008)}$
Reel Inner Diameter	D <sub>1</sub>	$\frac{80.0}{(3.150)}$ MIN.
Feed Hole Diameter	D <sub>2</sub>	$\frac{13.0 \pm 0.20}{(0.512 \pm 0.008)}$
Sprocket Hole Position	E	$\frac{1.75 \pm 0.10}{(0.069 \pm 0.004)}$
Punch Hole Position	F	$\frac{3.50 \pm 0.05}{(0.138 \pm 0.002)}$
Punch Hole Pitch	P	$\frac{4.00 \pm 0.10}{(0.157 \pm 0.004)}$
Sprocket Hole Pitch	P <sub>0</sub>	$\frac{4.00 \pm 0.10}{(0.157 \pm 0.004)}$
Embossment Center	P <sub>1</sub>	$\frac{2.00 \pm 0.05}{(0.079 \pm 0.002)}$
Overall Tape Thickness	T	$\frac{0.20 \pm 0.10}{(0.008 \pm 0.004)}$
Tape Width	W	$\frac{8.00 \pm 0.20}{(0.315 \pm 0.008)}$
Reel Width	W <sub>1</sub>	$\frac{13.5}{(0.531)}$ MIN.
Quantity per Reel	—	3,000

REV. 01/18

Specifications are subject to change without notice.

The device characteristics and parameters in this data sheet can and do vary in different applications and actual device performance may vary over time. Users should verify actual device performance in their specific applications.