



**THE DATASHEET OF
CZRF52C5V1-HF**



CZRF52C2-HF Thru. CZRF52C39-HF

Voltage 2 to 39 Volts

Power 350 mWatts

RoHS Device

Halogen Free



Features

- 350mW Power Dissipation.
- High Voltages from 2 ~ 39 V.
- Designed for mounting on small surface.
- Extremely thin/leadless package.
- Pb free product.

Mechanical data

- Case: 1005/SOD-323F Standard package
Molded plastic.
- Terminals: Gold plated, solderable per MIL-STD-750,method 2026.
- Polarity: Indicated by cathode band.
- Weight: 0.006 gram(approx.).

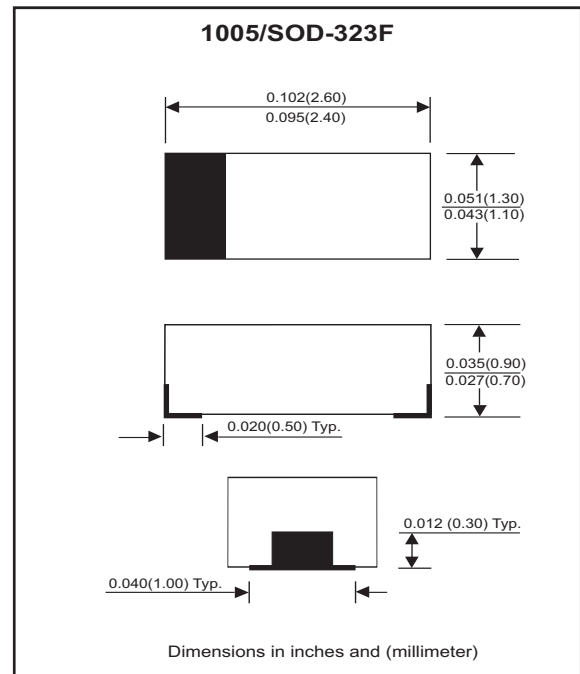

Circuit Diagram



Maximum Rating And Electrical Characteristics (at TA=25°C unless otherwise noted)

Parameter	Symbol	Value	Unit
Maximum Forward Voltage Drop at $I_F = 10 \text{ mA}$	V_F	0.9	V
Maximum Power Dissipation at 25 °C	P_D	350	mW
Forward current , surge peak 8.3 ms single half sine-wave superimposed on rate load(JEDEC method)	I_{FSM}	2.0	A
Peak ESD voltage capability (IEC 61000-4-2)	V_{PV}	8	kV
Operating Junction and Storage Temperature Range	T_J	-55 to +125	°C

Electrical Characteristics(Ta = 25°C)

Part Number	Marking Code	Zener Voltage			Operating resistance		Rising operating Resistance		Reverse current	
		V _Z (V)			ZZT(Ohm)		ZZK(Ohm)		IR(μA)	
		Min	Max	I _Z (mA)	Max	I _Z (mA)	Max	I _Z (mA)	Max	V _R (V)
CZRF52C2-HF	Z0	1.90	2.10	5	100	5	600	1	100	1
CZRF52C2V2-HF	Z1	2.09	2.31	5	100	5	600	1	100	1
CZRF52C2V4-HF	Z2	2.28	2.52	5	85	5	600	1	100	1
CZRF52C2V7-HF	Z3	2.57	2.84	5	83	5	500	1	75	1
CZRF52C3-HF	Z4	2.85	3.15	5	95	5	500	1	50	1
CZRF52C3V3-HF	Z5	3.14	3.47	5	95	5	500	1	25	1
CZRF52C3V6-HF	Z6	3.42	3.78	5	95	5	500	1	15	1
CZRF52C3V9-HF	Z7	3.71	4.10	5	95	5	500	1	10	1
CZRF52C4V3-HF	Z8	4.09	4.52	5	95	5	500	1	5	1
CZRF52C4V7-HF	Z9	4.47	4.94	5	78	5	500	1	5	2
CZRF52C5V1-HF	ZA	4.85	5.36	5	60	5	480	1	0.1	0.8
CZRF52C5V6-HF	ZB	5.32	5.88	5	40	5	400	1	0.1	1
CZRF52C6V2-HF	ZC	5.89	6.51	5	10	5	200	1	0.1	2
CZRF52C6V8-HF	ZE	6.46	7.14	5	8	5	150	1	0.1	3
CZRF52C7V5-HF	ZF	7.13	7.88	5	7	5	50	1	0.1	5
CZRF52C8V2-HF	ZG	7.79	8.61	5	7	5	50	1	0.1	6
CZRF52C9V1-HF	ZH	8.65	9.56	5	10	5	50	1	0.1	7
CZRF52C10-HF	ZJ	9.50	10.50	5	15	5	70	1	0.1	7.5
CZRF52C11-HF	ZK	10.45	11.55	5	20	5	70	1	0.1	8.5
CZRF52C12-HF	ZM	11.40	12.60	5	20	5	90	1	0.1	9
CZRF52C13-HF	ZN	12.35	13.65	5	25	5	110	1	0.1	10
CZRF52C15-HF	ZP	14.25	15.75	5	30	5	110	1	0.1	11
CZRF52C16-HF	ZQ	15.20	16.80	5	40	5	170	1	0.1	12
CZRF52C18-HF	ZR	17.10	18.90	5	50	5	170	1	0.1	14
CZRF52C20-HF	ZS	19.00	21.00	5	50	5	220	1	0.1	15
CZRF52C22-HF	ZT	20.90	23.10	5	55	5	220	1	0.1	17
CZRF52C24-HF	ZU	22.80	25.20	5	80	5	220	1	0.1	18
CZRF52C27-HF	ZV	25.65	28.35	5	80	5	250	1	0.1	20
CZRF52C30-HF	ZW	28.50	31.50	5	80	5	250	1	0.1	23
CZRF52C33-HF	ZX	31.35	34.65	5	80	5	250	1	0.1	25
CZRF52C36-HF	ZY	34.20	37.80	5	90	5	250	1	0.1	27
CZRF52C39-HF	ZZ	37.05	40.95	5	90	5	300	1	0.1	29

Company reserves the right to improve product design , functions and reliability without notice.

REV:B

RATING AND CHARACTERISTIC CURVES (CZRF52C2-HF Thru. CZRF52C39-HF)

Fig.1 TEMPERATURE COEFFICIENTS

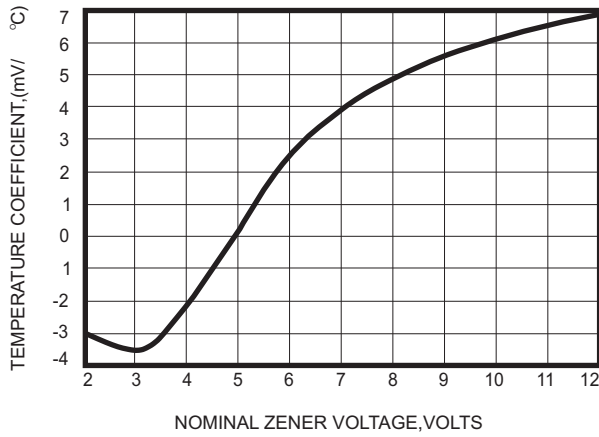

Fig.2 TEMPERATURE COEFFICIENTS

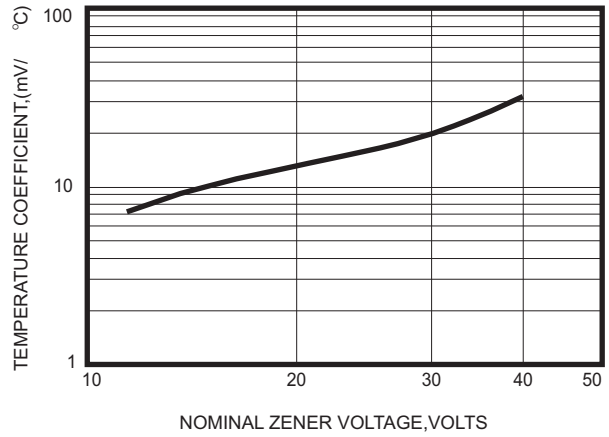

Fig.3 EFFECT OF ZENER VOLTAGE ON ZENER IMPEDANCE

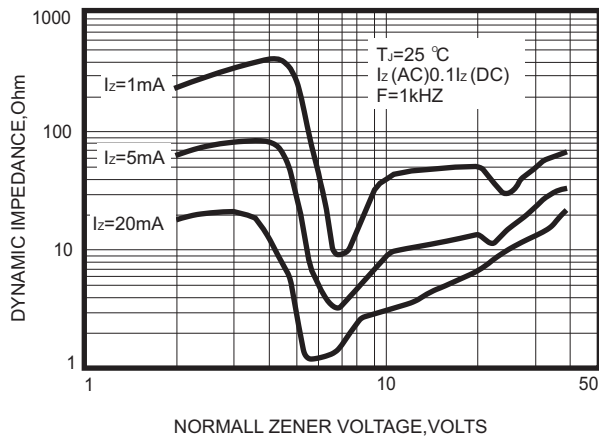

Fig.4 TYPICAL FORWARD VOLTAGE

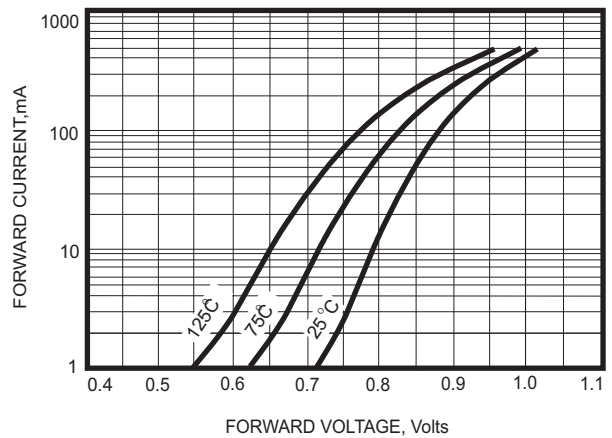

Fig.5 TYPICAL LEAKAGE CURRENT

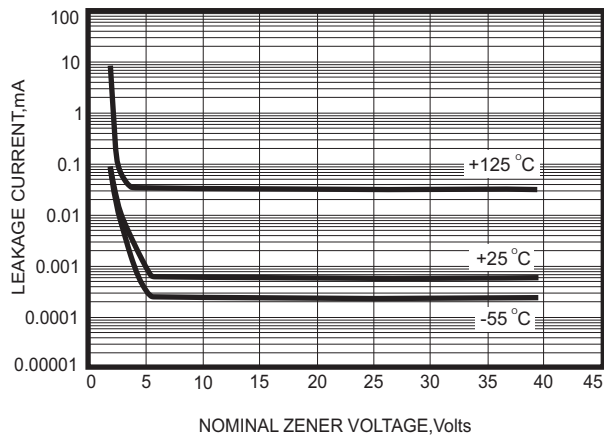
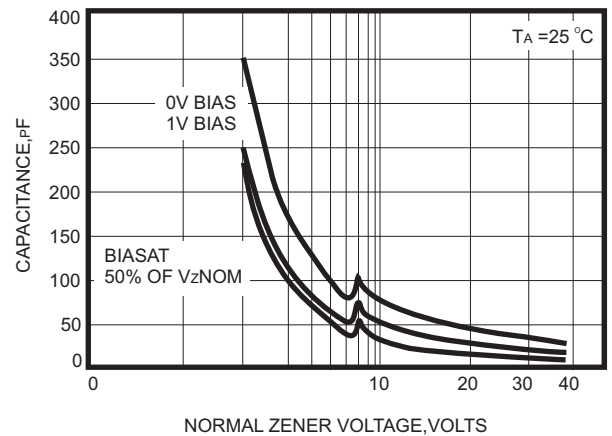

Fig.6 TYPICAL CAPACITANCE



Company reserves the right to improve product design, functions and reliability without notice.

RATING AND CHARACTERISTIC CURVES (CZRF52C2-HF Thru. CZRF52C39-HF)

Fig.7 ZENER VOLTAGE VERSUS ZENER CURRENT

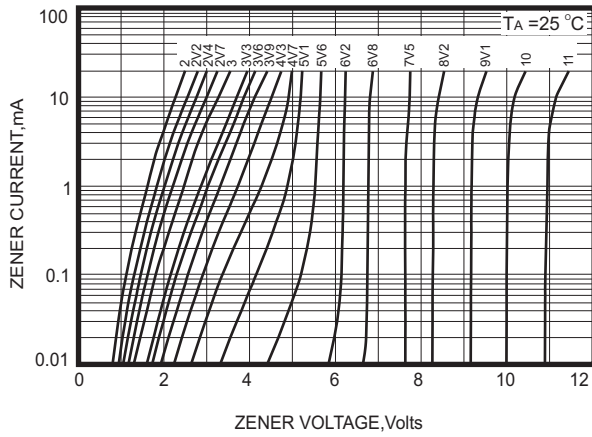

Fig.8 ZENER VOLTAGE VERSUS ZENER CURRENT

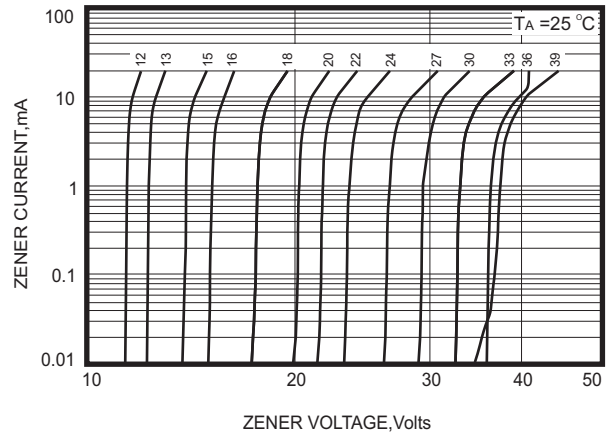
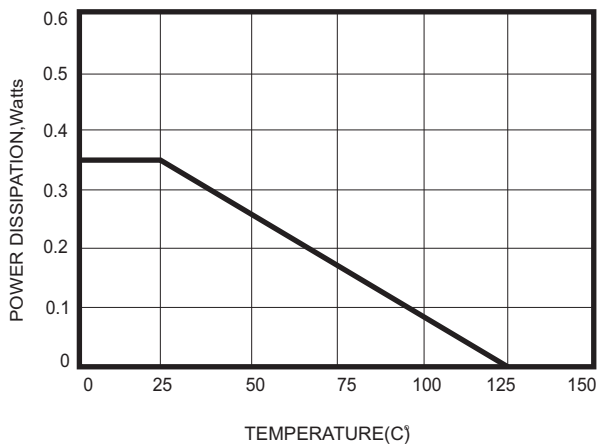
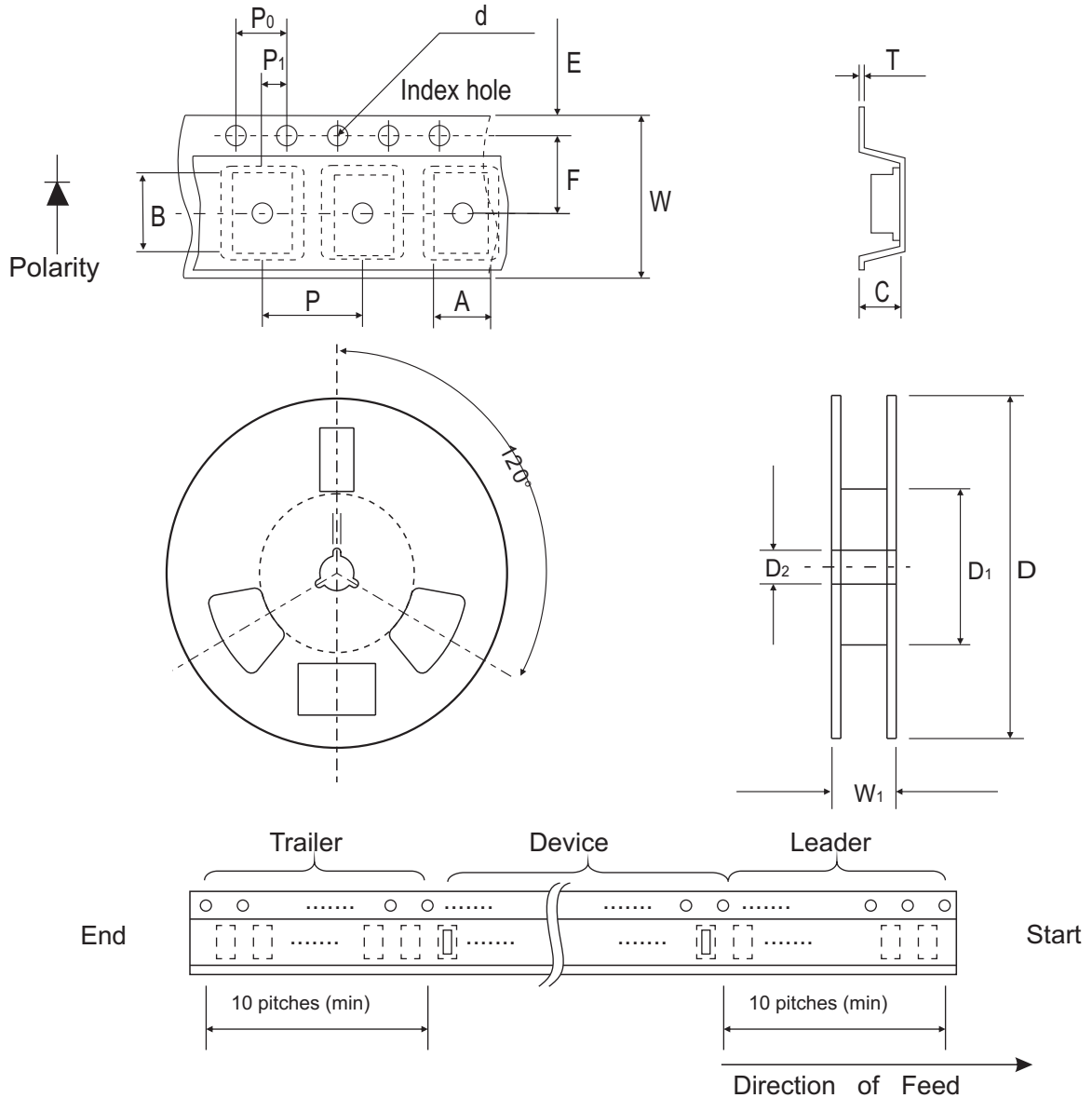

Fig.9 STEADY STATE POWER DERATING



Reel Taping Specification



1005 (SOD-323F)	SYMBOL	A	B	C	d	D	D ₁	D ₂
	(mm)	1.55 ± 0.10	2.65 ± 0.10	1.05 ± 0.10	1.55 ± 0.05	178 ± 1	60.0 MIN.	13.0 ± 0.20
	(inch)	0.061 ± 0.004	0.104 ± 0.004	0.041 ± 0.004	0.061 ± 0.002	7.008 ± 0.04	2.362 MIN.	0.512 ± 0.008

1005 (SOD-323F)	SYMBOL	E	F	P	P ₀	P ₁	T	W	W ₁
	(mm)	1.75 ± 0.10	3.50 ± 0.05	4.00 ± 0.10	4.00 ± 0.10	2.00 ± 0.05	0.23 ± 0.05	8.00 ± 0.20	13.5 MAX.
	(inch)	0.069 ± 0.004	0.138 ± 0.002	0.157 ± 0.004	0.157 ± 0.004	0.079 ± 0.002	0.009 ± 0.002	0.315 ± 0.008	0.531 MAX.

Company reserves the right to improve product design, functions and reliability without notice.

REV:B

Suggested PAD Layout

SIZE	1005/SOD-323F	
	(mm)	(inch)
A	2.10	0.083
B	1.20	0.047
C	1.20	0.047
D	3.30	0.130
E	0.90	0.035

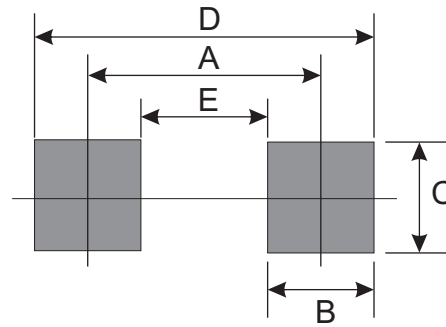

Standard Packaging

Case Type	Qty per Reel	Reel Size
	(Pcs)	(inch)
1005/SOD-323F	4,000	7