



Jiangsu Everstar Electronics Co., Ltd.
Address: No.111 Tianmu Rd, Tianmuhu Town, Liyang City, Jiangsu Province, China
TEL: +86-519-87557772 FAX: +86-519-87557773
Http: www.everstarelect.com

DATA SHEET

ESL NO.. : ESS-JC170DWS4

CUSNO.. :

REV : A / 0

Producer: Eden Auditor: _____ Approver: Jack

CUSTOMER'S APPROVAL : _____ DCC : _____



2.0×1.25×0.8 mm SMD LED

ESS-JC170DWS4

REV:A0

PACKAGE DIMENSIONS

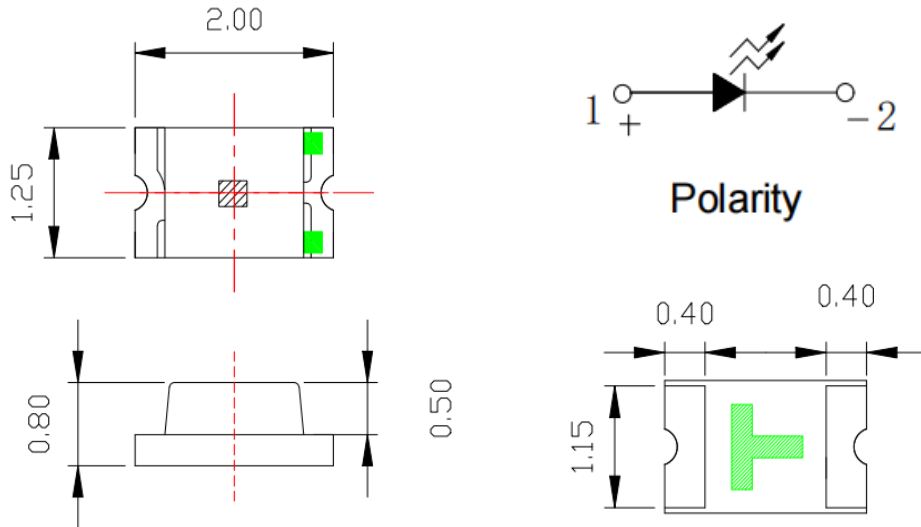

Soldering PAD Suggested:

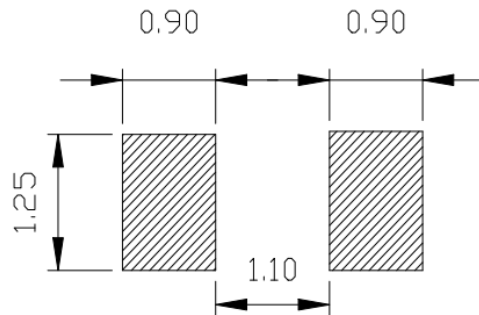

Note:

1. All Dimensions are in millimeters
2. The Tolerances Mentioned is ± 0.1 mm Unless otherwise specified.



2.0×1.25×0.8 mm SMD LED

ESS-JC170DWS4

REV:A0

Feature:

- * High Luminous Intensity
- * Low Power Dissipation
- * good Reliability
- * Long Life

Applications:

- * household appliance
- * dashboard
- * communication equipmen

CHIP MATERIALS :

- * Dice Material: InGaN
- * Lens Color: Yellow
- * Light Color: White

ABSOLUTE MAXIMUM RATING : (Ta = 25°C)

Symbol	DESCRIPTION	Rated	Unit
Topr	Operating Temperature Range	-30°C ~ +85°C	
Tstg	Storage Temperature Range	-40°C ~ +100°C	
VR	Reverse Voltage Per Chip	5	V
PD	Power Dissipation Per Chip	90	mW
IF	Average Forward Current Per Chip	25	mA
IFp	Peak Forward Current Per Chip	100	mA

* Positive pulse current (Duty=0.1,1KHZ)

ELECTRO-OPTICAL CHARACTERISTICS : (Ta = 25°C)

Parameter	Symbol	Condition	MIN.	TYP	MAX	UNIT
Reverse Current	IR	VR=5V	/	/	50	μA
Forward Voltage	VF	IF=20mA	2.6	/	3.2	V
Luminous Intensity	IV		500	700		mcd
Correlated Color Temperature	CCT		6000	/	9000	K
View Angle	2θ1/2		/	130	/	deg



2.0×1.25×0.8 mm SMD LED

ESS-JC170DWS4

REV:A0

Typical Electro-Optical Characteristics Curves

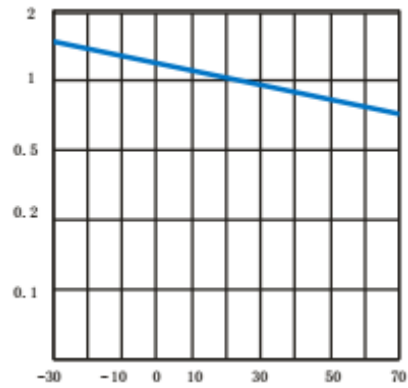
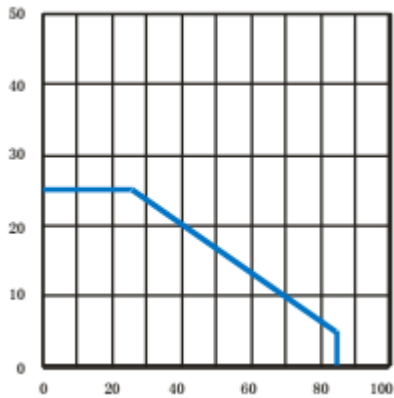
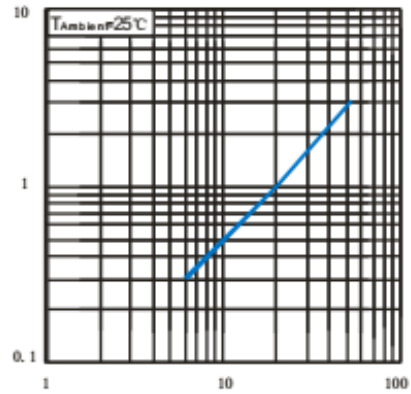
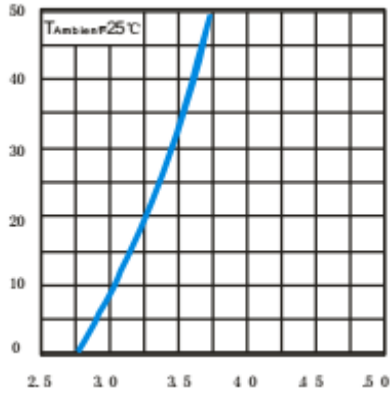



2.0×1.25×0.8 mm SMD LED

ESS-JC170DWS4

REV:A0

Chromatic Coordinates Ranks



2.0×1.25×0.8 mm SMD LED

ESS-JC170DWS4

REV:A0

Reel and Tape Dimensions: (Quantity: 3000pcs/Reel)

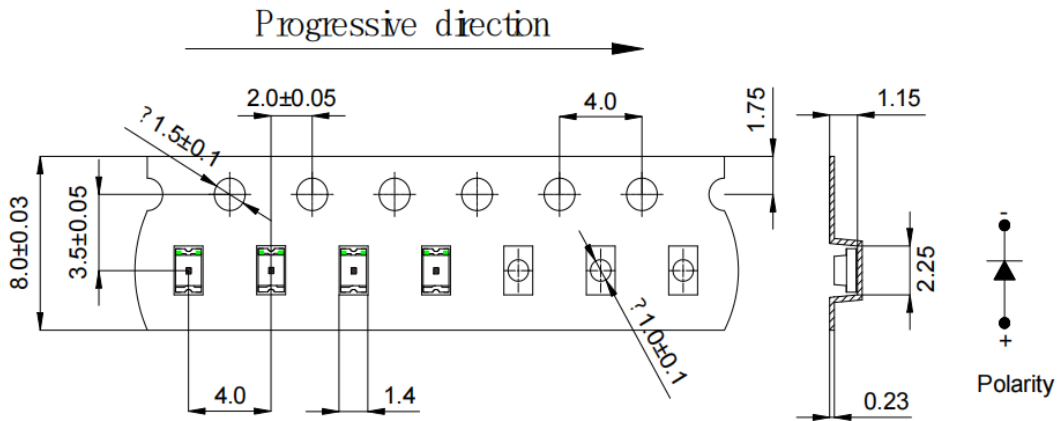
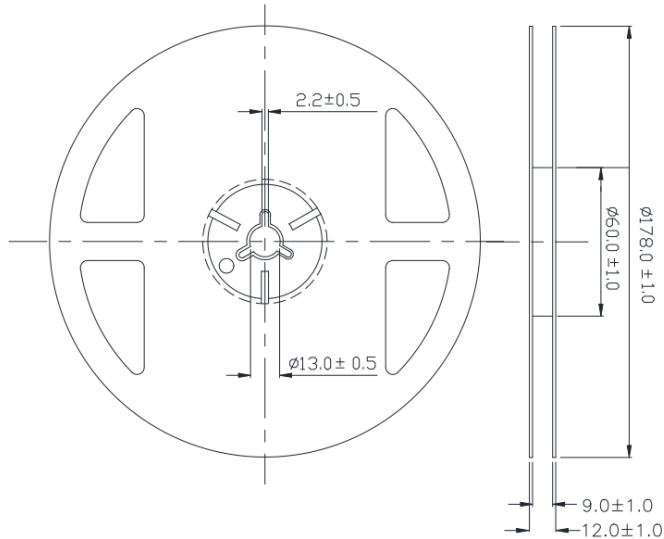

Note:

- 1. All Dimensions are in millimeters
- 2. Tolerance is ± 0.1 Unless otherwise specified



2.0×1.25×0.8 mm SMD LED

ESS-JC170DWS4

REV:A0

Packaging:

Moisture Proof and Anti-Electrostatic Foil Bag

Cardboard Box

Application

1. A LED is a current-operated device. The slight shift of voltage will cause big change of current, which will damage LEDs. Customer should use resistors in series for the Over-Current-Proof.
2. In order to ensure intensity uniformity on multiple LEDs connected in parallel in an application, it is recommended to use individual resistor separately, as shown in Circuit A below. The brightness of each LED shown in Circuit B might appear difference due to the differences in the I-V characteristics of those LEDs.

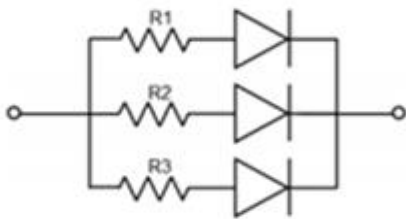

Circuit model A

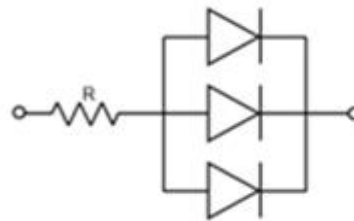

Circuit model B

3. High temperature may reduce LEDs' intensity and other performances, so keeping it away from heat source to get good performance is necessary.

Storage

1. Before opening original package, it is recommended to store them in the following environment:
 Temperature: 5°C~30°C Humidity: 85%RH max.
2. After opening original package, the storage ambient for the LEDs should be in 5~30°C temperature and 60% or less relative humidity.
3. In order to avoid moisture absorption, it is recommended that the LEDs that out of the original package should be stored in a sealed container with appropriate desiccant, or in desiccators with nitrogen ambient.
4. The LEDs should be used within 168hrs (7 days) after opening the package. Once been mounted, soldering should be quick.
5. If the moisture absorbent material (silica gel) has faded away or the LEDs stored out of original package for more than 168hrs (7 days), baking treatment should be performed using the conditions:
 60°C at least 24 hours.

ESD (Electrostatic Discharge)-Protection

A LED (especially the Blue、White and Green product) is an ESD sensitive component, and static electricity or power surge will damage the LED. ESD-damaged LEDs will exhibit abnormal characteristics such as high reverse leakage current, low forward voltage, or "no light-up" at low currents, etc.

Some advice as below should be noticed:

1. A conductive wrist strap or anti-electrostatic glove should be worn when handling these LEDs.



2.0×1.25×0.8 mm SMD LED

ESS-JC170DWS4

REV:A0

2. All devices, equipment, machinery, work tables and storage racks, etc. must be properly grounded.
3. Use anti-static package or boxes to carry and storage LEDs. And ordinary plastic package or boxes is forbidden to use.
4. Use ionizer to neutralize the static charge during handling or operating.
5. All surfaces and objects within 1 ft close to LEDs measure less than 100V.

Cleaning

Use alcohol-based cleaning solvents such as IPA (isopropyl alcohol) to clean LEDs if necessary.

Soldering

1. Soldering condition refer to the draft "Soldering Profile Suggested" on page 1.
2. Reflow soldering should not be done more than 2 times.
3. Manual soldering is only suggested on repair and rework. The maximum soldering temperature should not exceed 300°C within 3 sec. And the maximum capacity of soldering iron is 30W in power.
4. During the soldering process, do not touch the lens at high temperature.
5. After soldering, any mechanical force on the lens or any excessive vibration shall not be accepted to apply, also the circuit board shall not be bent as well.

Others

1. The LEDs described here are intended to be used for ordinary electronic equipment (such as office equipment, communication equipment and household applications).Consult Harvatek's Sales in advance for the applications in which exceptional reliability is required, particularly when the failure or malfunction of the LEDs may directly jeopardize life or health. (such as in aviation, transportation, traffic control equipment, medical and life support systems and safety devices).
2. The light output from the high luminous intensity LEDs may cause injury to human eyes when viewed directly.
3. The appearance and specifications of the product may be modified for improvement without prior notice.