



**THE DATASHEET OF  
ADXL350BCEZ-RL7**



## FEATURES

- Excellent zero-g bias accuracy and stability with minimum/maximum specifications**
- Ultralow power: as low as 45  $\mu\text{A}$  in measurement mode and 0.1  $\mu\text{A}$  in standby mode at  $V_S = 2.5\text{ V}$  (typical)**
- Power consumption scales automatically with bandwidth**
- User-selectable resolution**
  - Fixed 10-bit resolution
  - Full resolution, where resolution increases with  $g$  range, up to 13-bit resolution at  $\pm 8g$  (maintains 2 mg/LSB scale factor in all  $g$  ranges)
- Embedded, 32-level FIFO buffer minimizes host processor load**
- Tap/double tap detection and free-fall detection**
- Activity/inactivity monitoring**
- Supply voltage range: 2.0 V to 3.6 V**
- I/O voltage range: 1.7 V to  $V_S$**
- SPI (3- and 4-wire) and I<sup>2</sup>C digital interfaces**
- Flexible interrupt modes mappable to either interrupt pin**
- Measurement ranges selectable via serial command**
- Bandwidth selectable via serial command**
- Wide temperature range ( $-40^\circ\text{C}$  to  $+85^\circ\text{C}$ )**
- 10,000  $g$  shock survival**
- Pb-free/RoHS compliant**
- Small and thin: 4 mm  $\times$  3 mm  $\times$  1.2 mm cavity LGA package**

## APPLICATIONS

- Portable consumer devices
- High performance medical and industrial applications

## GENERAL DESCRIPTION

The high performance **ADXL350** is a small, thin, low power, 3-axis accelerometer with high resolution (13-bit) and selectable measurement ranges up to  $\pm 8g$ . The **ADXL350** offers industry-leading noise and temperature performance for application robustness with minimal calibration. Digital output data is formatted as 16-bit twos complement and is accessible through either a SPI (3- or 4-wire) or I<sup>2</sup>C digital interface.

The **ADXL350** is well suited for high performance portable applications. It measures the static acceleration of gravity in tilt-sensing applications, as well as dynamic acceleration resulting from motion or shock. Its high resolution (2 mg/LSB) enables measurement of inclination changes of less than  $1.0^\circ$ .

Several special sensing functions are provided. Activity and inactivity sensing detect the presence or lack of motion and if the acceleration on any axis exceeds a user-set level. Tap sensing detects single and double taps. Free-fall sensing detects if the device is falling. These functions can be mapped to one of two interrupt output pins.

Low power modes enable intelligent motion-based power management with threshold sensing and active acceleration measurement at extremely low power dissipation.

The **ADXL350** is supplied in a small, thin, 3 mm  $\times$  4 mm  $\times$  1.2 mm, 16-lead cavity laminate package.

## FUNCTIONAL BLOCK DIAGRAM

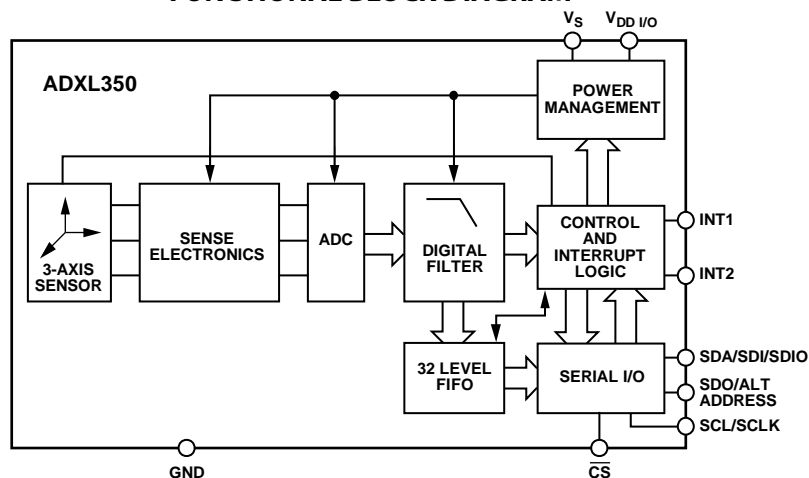

Figure 1.

Rev. 0

[Document Feedback](#)

Information furnished by Analog Devices is believed to be accurate and reliable. However, no responsibility is assumed by Analog Devices for its use, nor for any infringements of patents or other rights of third parties that may result from its use. Specifications subject to change without notice. No license is granted by implication or otherwise under any patent or patent rights of Analog Devices. Trademarks and registered trademarks are the property of their respective owners.

One Technology Way, P.O. Box 9106, Norwood, MA 02062-9106, U.S.A.  
 Tel: 781.329.4700 ©2012 Analog Devices, Inc. All rights reserved.  
[Technical Support](#) [www.analog.com](http://www.analog.com)

**TABLE OF CONTENTS**

Features .....	1	Interrupts.....	21
Applications.....	1	FIFO .....	21
General Description .....	1	Self-Test .....	22
Functional Block Diagram .....	1	Register Map .....	23
Revision History .....	2	Register Definitions .....	24
Specifications.....	3	Applications Information .....	28
Absolute Maximum Ratings.....	4	Power Supply Decoupling .....	28
Thermal Resistance .....	4	Mechanical Considerations for Mounting.....	28
Package Information .....	4	Tap Detection.....	28
ESD Caution.....	4	Threshold .....	29
Pin Configuration and Function Descriptions.....	5	Link Mode .....	29
Typical Performance Characteristics .....	6	Sleep Mode vs. Low Power Mode.....	29
Theory of Operation .....	14	Offset Calibration .....	29
Power Sequencing .....	14	Using Self-Test .....	30
Power Savings.....	15	Axes of Acceleration Sensitivity .....	32
Serial Communications .....	16	Layout and Design Recommendations .....	33
SPI.....	16	Outline Dimensions .....	34
I <sup>2</sup> C.....	19	Ordering Guide .....	34

**REVISION HISTORY**

**9/12—Revision 0: Initial Version**

## SPECIFICATIONS

$T_A = 25^\circ\text{C}$ ,  $V_S = 2.5\text{ V}$ ,  $V_{DDI/O} = 2.5\text{ V}$ , acceleration = 0 g, and  $C_{IO} = 0.1\ \mu\text{F}$ , unless otherwise noted. All minimum and maximum specifications are guaranteed. Typical specifications are not guaranteed.

Table 1.

Parameter	Test Conditions	Min	Typ	Max	Unit
<b>SENSOR INPUT</b>					
Measurement Range	Each axis User selectable		$\pm 1, \pm 2, \pm 4, \pm 8$		g
Nonlinearity	Percentage of full scale		$\pm 0.5$		%
Inter-Axis Alignment Error			$\pm 0.1$		Degrees
Cross-Axis Sensitivity <sup>1</sup>			$\pm 3$		%
<b>OUTPUT RESOLUTION</b>					
All g Ranges	Each axis 10-bit resolution		10		Bits
$\pm 1\text{ g}$ Range	Full resolution		10		Bits
$\pm 2\text{ g}$ Range	Full resolution		11		Bits
$\pm 4\text{ g}$ Range	Full resolution		12		Bits
$\pm 8\text{ g}$ Range	Full resolution		13		Bits
<b>SENSITIVITY</b>					
Sensitivity at $X_{OUT}, Y_{OUT}, Z_{OUT}$	Each axis Any g-range, full resolution	473.6	512	550.4	LSB/g
Scale Factor at $X_{OUT}, Y_{OUT}, Z_{OUT}$	Any g-range, full resolution	1.80	1.95	2.10	mg/LSB
Sensitivity at $X_{OUT}, Y_{OUT}, Z_{OUT}$	$\pm 1\text{ g}$ , 10-bit resolution	473.6	512	550.4	LSB/g
Scale Factor at $X_{OUT}, Y_{OUT}, Z_{OUT}$	$\pm 1\text{ g}$ , 10-bit resolution	1.80	1.95	2.10	mg/LSB
Sensitivity at $X_{OUT}, Y_{OUT}, Z_{OUT}$	$\pm 2\text{ g}$ , 10-bit resolution	236.8	256	275.2	LSB/g
Scale Factor at $X_{OUT}, Y_{OUT}, Z_{OUT}$	$\pm 2\text{ g}$ , 10-bit resolution	3.61	3.91	4.21	mg/LSB
Sensitivity at $X_{OUT}, Y_{OUT}, Z_{OUT}$	$\pm 4\text{ g}$ , 10-bit resolution	118.4	128	137.6	LSB/g
Scale Factor at $X_{OUT}, Y_{OUT}, Z_{OUT}$	$\pm 4\text{ g}$ , 10-bit resolution	7.22	7.81	8.40	mg/LSB
Sensitivity at $X_{OUT}, Y_{OUT}, Z_{OUT}$	$\pm 8\text{ g}$ , 10-bit resolution	59.2	64	68.8	LSB/g
Scale Factor at $X_{OUT}, Y_{OUT}, Z_{OUT}$	$\pm 8\text{ g}$ , 10-bit resolution	14.45	15.63	16.80	mg/LSB
Sensitivity Change Due to Temperature			$\pm 0.01$		%/°C
<b>0 g BIAS LEVEL</b>					
0 g Output for $X_{OUT}, Y_{OUT}$	Each axis	-150	$\pm 50$	+150	Mg
0 g Output for $Z_{OUT}$		-250	$\pm 75$	+250	Mg
0 g Offset vs. Temperature (X Axis and Y Axis) <sup>2</sup>		-0.31	$\pm 0.17$	+0.31	mg/°C
0 g Offset vs. Temperature (Z Axis) <sup>2</sup>		-0.49	$\pm 0.24$	+0.49	mg/°C
<b>NOISE PERFORMANCE</b>					
Noise (X-Axis and Y-Axis)	100 Hz data rate, full resolution		1.1		LSB rms
Noise (Z-Axis)	100 Hz data rate, full resolution		1.7		LSB rms
<b>OUTPUT DATA RATE AND BANDWIDTH</b>					
Measurement Rate <sup>3</sup>	User selectable	6.25		3200	Hz
<b>SELF-TEST<sup>4</sup></b>					
Output Change in X-Axis	Data rate $\geq 100\text{ Hz}$ , $2.0\text{ V} \leq V_S \leq 3.6\text{ V}$	0.2		2.1	g
Output Change in Y-Axis		-2.1		-0.2	g
Output Change in Z-Axis		0.3		3.4	g
<b>POWER SUPPLY</b>					
Operating Voltage Range ( $V_S$ )		2.0	2.5	3.6	V
Interface Voltage Range ( $V_{DDI/O}$ )		1.7	1.8	$V_S$	V
Supply Current	Data rate > 100 Hz		166		$\mu\text{A}$
	Data rate < 10 Hz		45		$\mu\text{A}$
Standby Mode Leakage Current			0.1	2	$\mu\text{A}$
Turn-On Time <sup>5</sup>	Data rate = 3200 Hz		1.4		ms
<b>OPERATING TEMPERATURE RANGE</b>					
		-40		+85	°C

<sup>1</sup> Cross-axis sensitivity is defined as coupling between any two axes.

<sup>2</sup> Offset vs. temperature minimum/maximum specifications are guaranteed by characterization and represent a mean  $\pm 3\sigma$  distribution.

<sup>3</sup> Bandwidth is half the output data rate.

<sup>4</sup> Self-test change is defined as the output (g) when the SELF\_TEST bit = 1 (in the DATA\_FORMAT register) minus the output (g) when the SELF\_TEST bit = 0 (in the DATA\_FORMAT register). Due to device filtering, the output reaches its final value after  $4 \times \tau$  when enabling or disabling self-test, where  $\tau = 1/(\text{data rate})$ .

<sup>5</sup> Turn-on and wake-up times are determined by the user-defined bandwidth. At a 100 Hz data rate, the turn-on and wake-up times are each approximately 11.1 ms. For other data rates, the turn-on and wake-up times are each approximately  $\tau + 1.1$  in milliseconds, where  $\tau = 1/(\text{data rate})$ .

## ABSOLUTE MAXIMUM RATINGS

Table 2.

Parameter	Rating
Acceleration	
Any Axis, Unpowered	10,000 g
Any Axis, Powered	10,000 g
$V_S$	-0.3 V to +3.6 V
$V_{DD/IO}$	-0.3 V to +3.6 V
Digital Pins	-0.3 V to $V_{DD/IO} + 0.3$ V or 3.6 V, whichever is less
All Other Pins	-0.3 V to +3.6 V
Output Short-Circuit Duration (Any Pin to Ground)	Indefinite
Temperature Range	
Powered	-40°C to +105°C
Storage	-40°C to +105°C

Stresses above those listed under Absolute Maximum Ratings may cause permanent damage to the device. This is a stress rating only; functional operation of the device at these or any other conditions above those indicated in the operational section of this specification is not implied. Exposure to absolute maximum rating conditions for extended periods may affect device reliability.

## THERMAL RESISTANCE

Table 3. Package Characteristics

Package Type	$\theta_{JA}$	$\theta_{JC}$	Device Weight
16-Terminal LGA_CAV	150°C/W	85°C/W	20 mg

## PACKAGE INFORMATION

The information in Figure 2 and Table 4 provide details about the package branding for the [ADXL350](#). For a complete listing of product availability, see the Ordering Guide section.



Figure 2. Product Information on Package (Top View)

Table 4. Package Branding Information

Branding Key	Field Description
XL350B	Part identifier for <a href="#">ADXL350</a>
yw	Date code
VVVV	Factory lot code

## ESD CAUTION



**ESD (electrostatic discharge) sensitive device.** Charged devices and circuit boards can discharge without detection. Although this product features patented or proprietary protection circuitry, damage may occur on devices subjected to high energy ESD. Therefore, proper ESD precautions should be taken to avoid performance degradation or loss of functionality.

## PIN CONFIGURATION AND FUNCTION DESCRIPTIONS

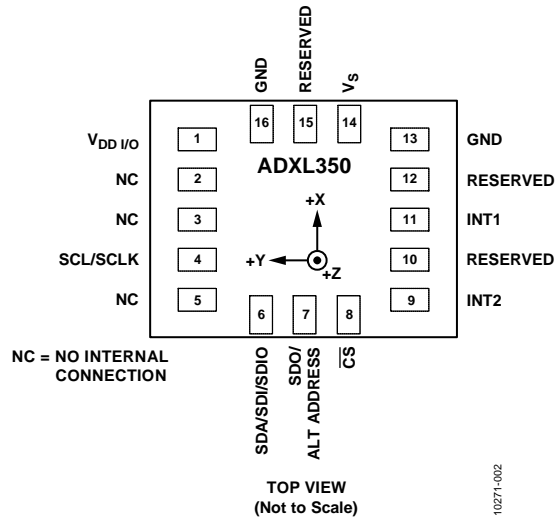

Figure 3. Pin Configuration

Table 5. Pin Function Descriptions

Pin No.	Mnemonic	Description
1	V <sub>DD I/O</sub>	Digital Interface Supply Voltage.
2	NC	Not Internally Connected.
3	NC	Not Internally Connected.
4	SCL/SCLK	Serial Communications Clock.
5	NC	Not Internally Connected.
6	SDA/SDI/SDIO	Serial Data (I <sup>2</sup> C)/Serial Data Input (SPI 4-Wire)/Serial Data Input and Output (SPI 3-Wire).
7	SDO/ALT ADDRESS	Serial Data Output/Alternate I <sup>2</sup> C Address Select.
8	$\overline{\text{CS}}$	Chip Select.
9	INT2	Interrupt 2 Output.
10	RESERVED	Reserved. This pin must be connected to ground or left open.
11	INT1	Interrupt 1 Output.
12	RESERVED	Reserved. This pin must be connected to ground.
13	GND	This pin must be connected to ground.
14	V <sub>S</sub>	Supply Voltage.
15	RESERVED	Reserved. This pin must be connected to V <sub>S</sub> or left open.
16	GND	This pin must be connected to ground.

# TYPICAL PERFORMANCE CHARACTERISTICS

N = 460 for all typical performance characteristics plots, unless otherwise noted.

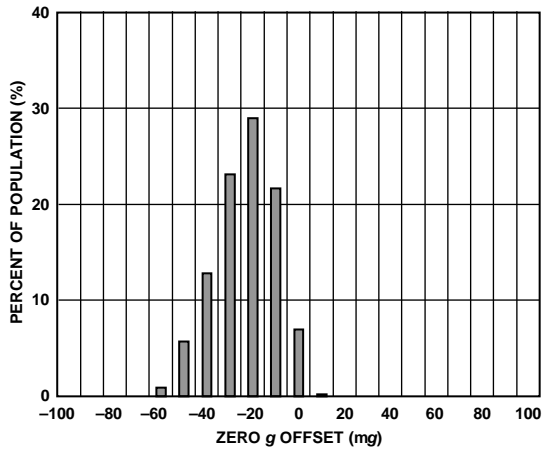

Figure 4. X-Axis Zero g Offset at 25°C,  $V_S = 2.5 V$

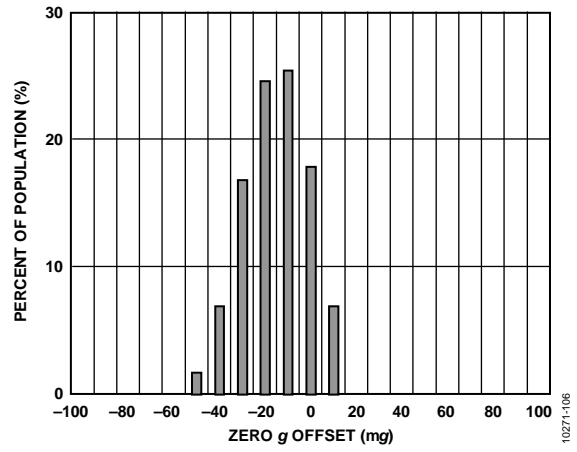

Figure 7. X-Axis Zero g Offset at 25°C,  $V_S = 3.0 V$

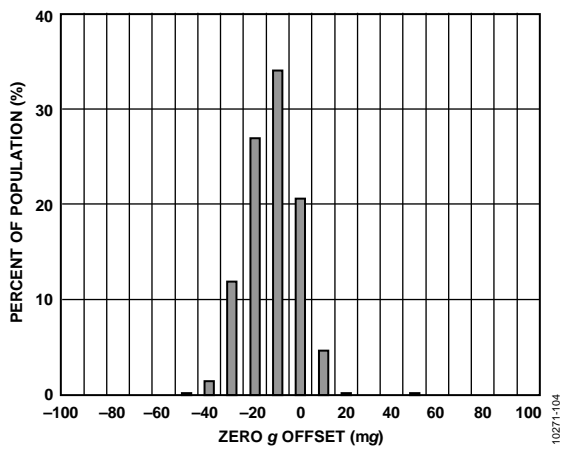

Figure 5. Y-Axis Zero g Offset at 25°C,  $V_S = 2.5 V$

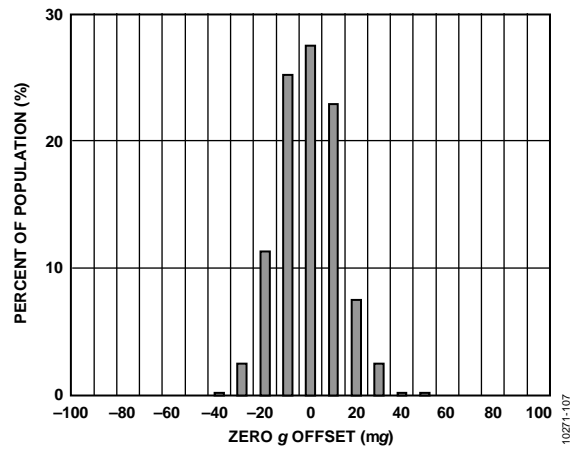

Figure 8. Y-Axis Zero g Offset at 25°C,  $V_S = 3.0 V$

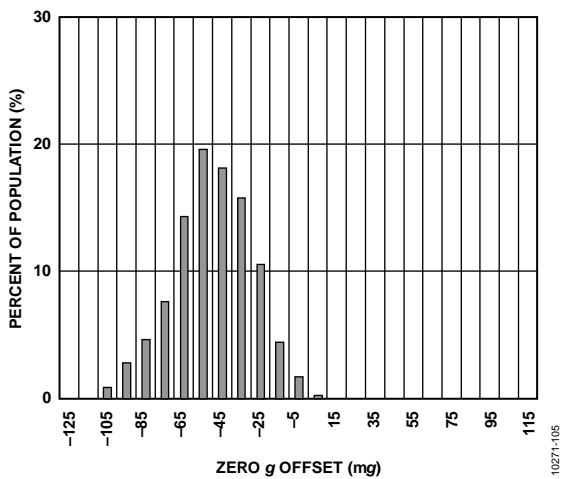

Figure 6. Z-Axis Zero g Offset at 25°C,  $V_S = 2.5 V$

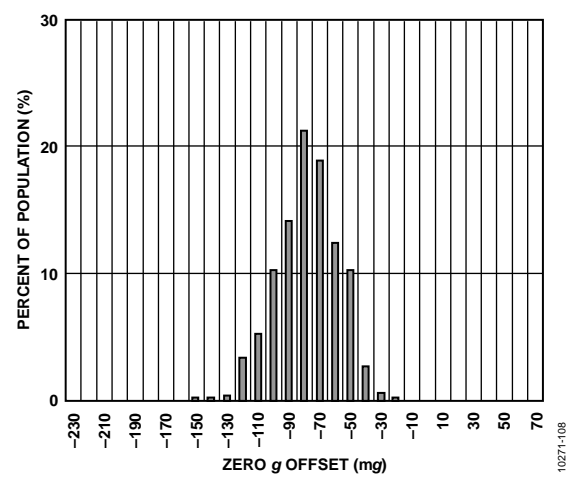

Figure 9. Z-Axis Zero g Offset at 25°C,  $V_S = 3.0 V$

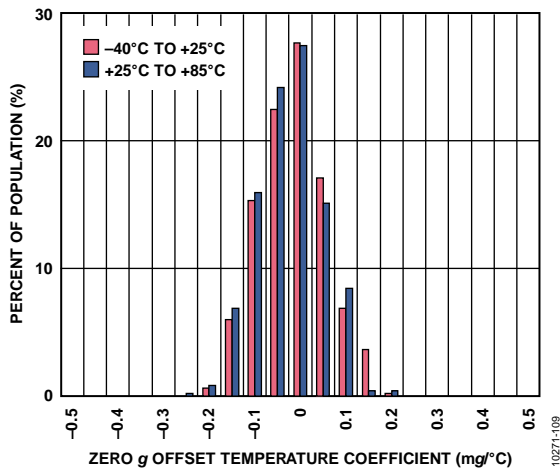

Figure 10. X-Axis Zero g Offset Temperature Coefficient,  $V_S = 2.5\text{ V}$

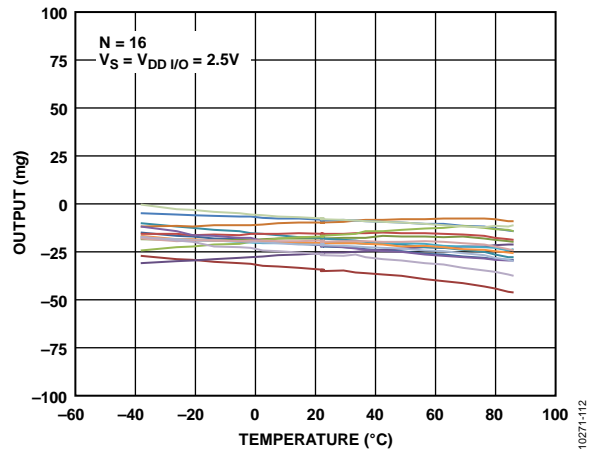

Figure 13. X-Axis Zero g Offset vs. Temperature—  
16 Parts Soldered to PCB,  $V_S = 2.5\text{ V}$

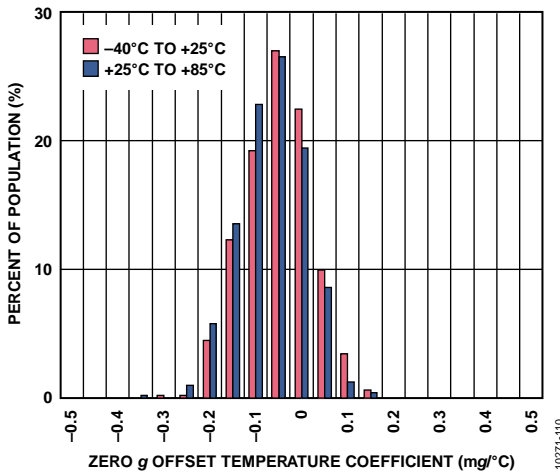

Figure 11. Y-Axis Zero g Offset Temperature Coefficient,  $V_S = 2.5\text{ V}$

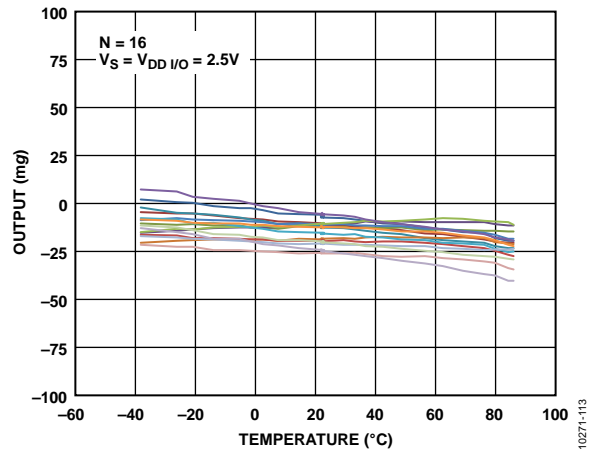

Figure 14. Y-Axis Zero g Offset vs. Temperature—  
16 Parts Soldered to PCB,  $V_S = 2.5\text{ V}$

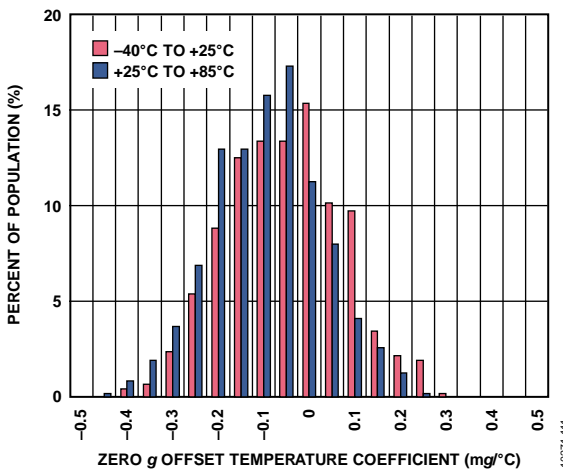

Figure 12. Z-Axis Zero g Offset Temperature Coefficient,  $V_S = 2.5\text{ V}$

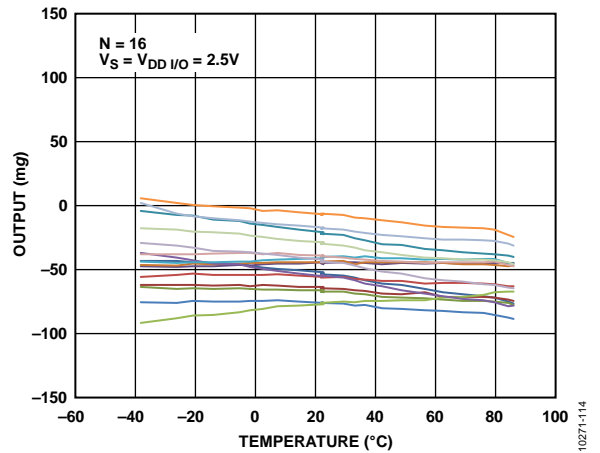

Figure 15. Z-Axis Zero g Offset vs. Temperature—  
16 Parts Soldered to PCB,  $V_S = 2.5\text{ V}$



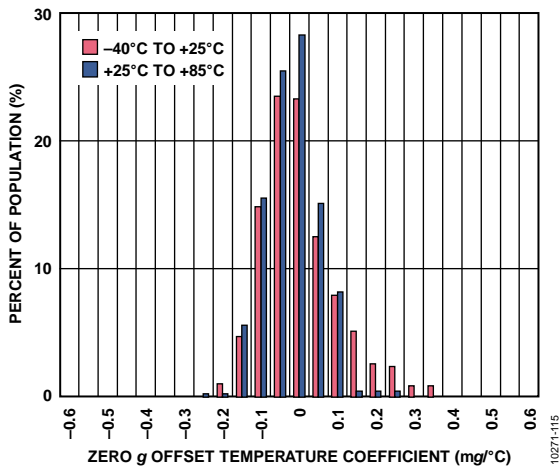

Figure 16. X-Axis Zero g Offset Temperature Coefficient,  $V_S = 3.0\text{ V}$

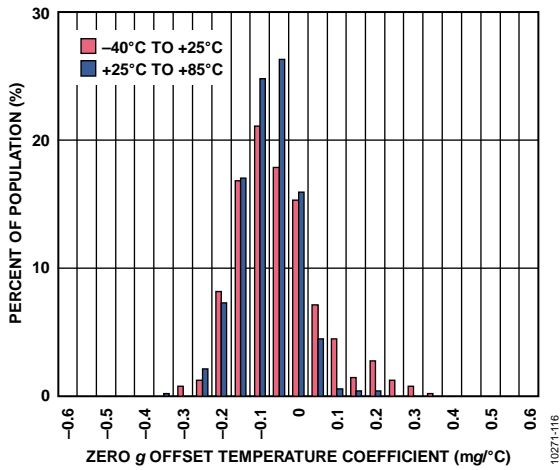

Figure 17. Y-Axis Zero g Offset Temperature Coefficient,  $V_S = 3.0\text{ V}$

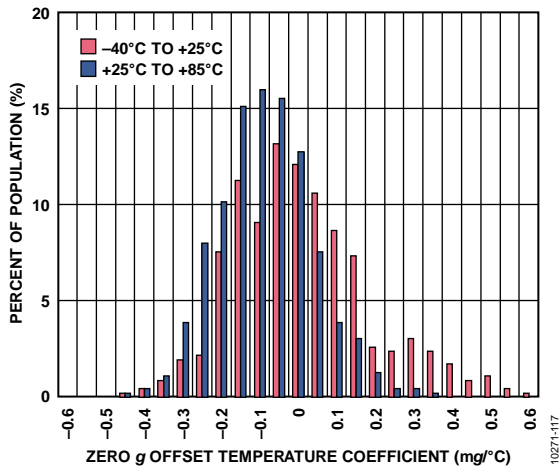

Figure 18. Z-Axis Zero g Offset Temperature Coefficient,  $V_S = 3.0\text{ V}$

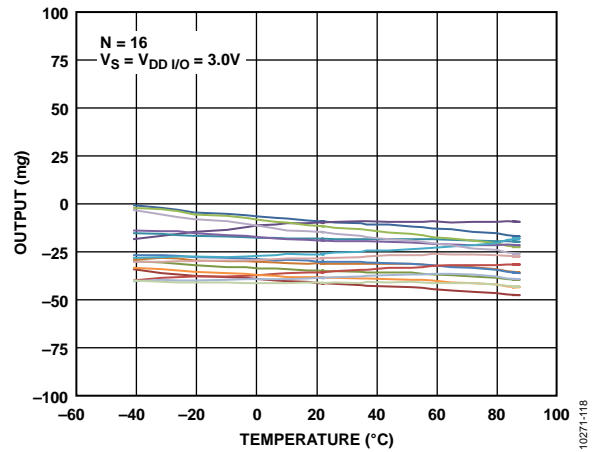

Figure 19. X-Axis Zero g Offset vs. Temperature—  
16 Parts Soldered to PCB,  $V_S = 3.0\text{ V}$

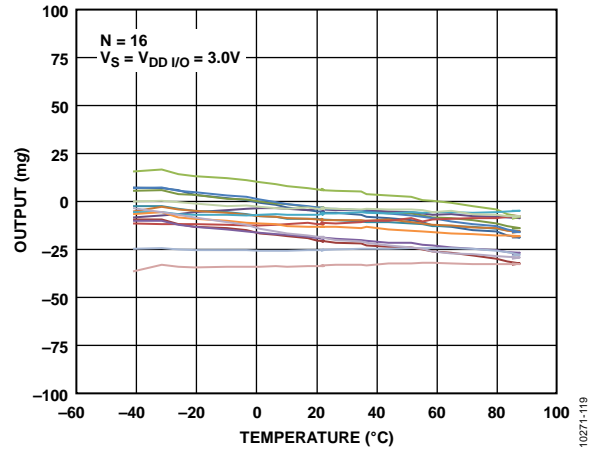

Figure 20. Y-Axis Zero g Offset vs. Temperature—  
16 Parts Soldered to PCB,  $V_S = 3.0\text{ V}$

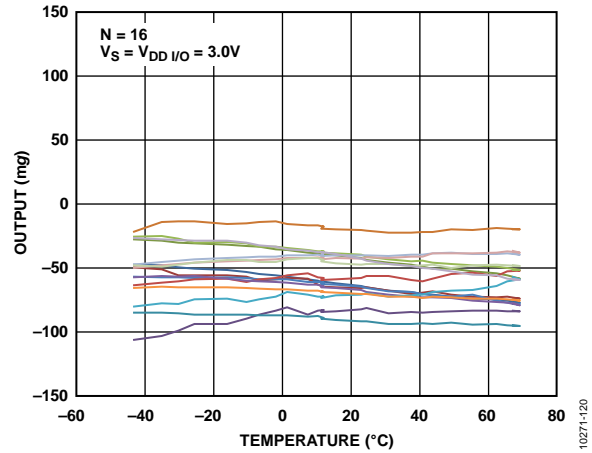

Figure 21. Z-Axis Zero g Offset vs. Temperature—  
16 Parts Soldered to PCB,  $V_S = 3.0\text{ V}$

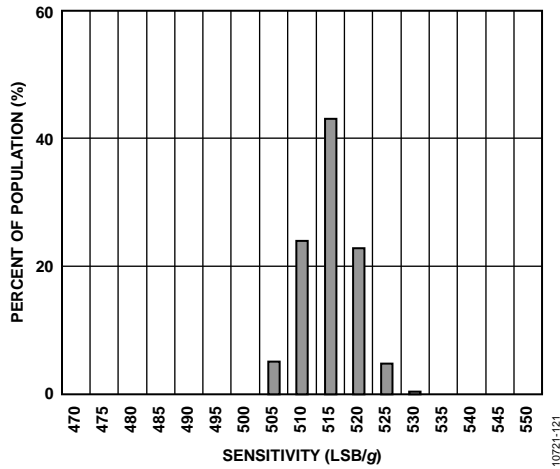

Figure 22. X-Axis Sensitivity at 25°C,  $V_s = 2.5 V$ , Full Resolution

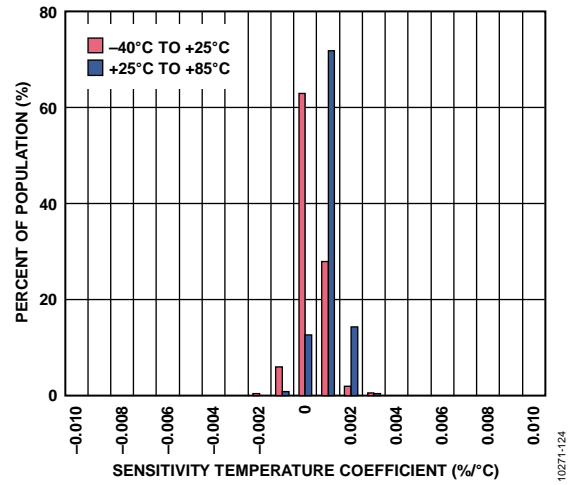

Figure 25. X-Axis Sensitivity Temperature Coefficient,  $V_s = 2.5 V$

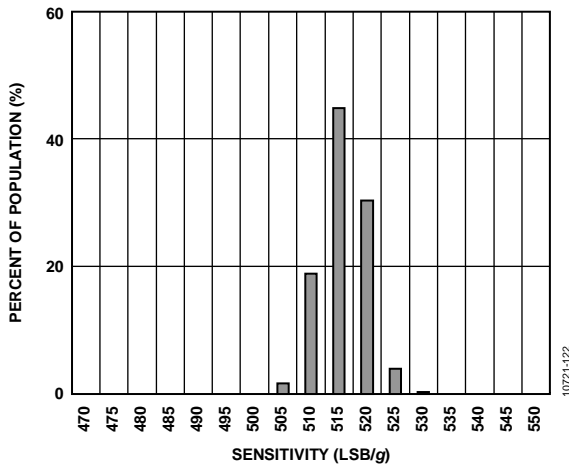

Figure 23. Y-Axis Sensitivity at 25°C,  $V_s = 2.5 V$ , Full Resolution

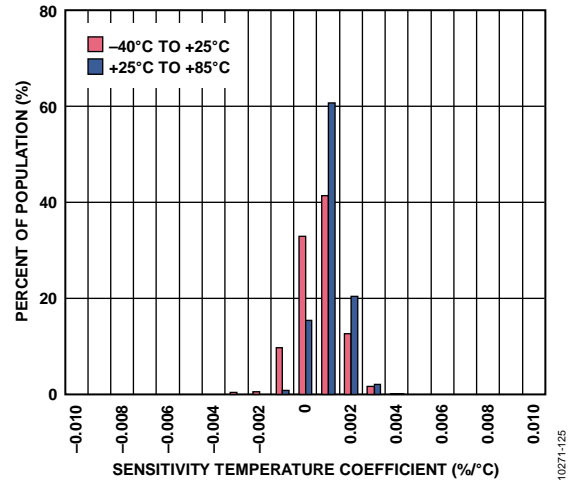

Figure 26. Y-Axis Sensitivity Temperature Coefficient,  $V_s = 2.5 V$

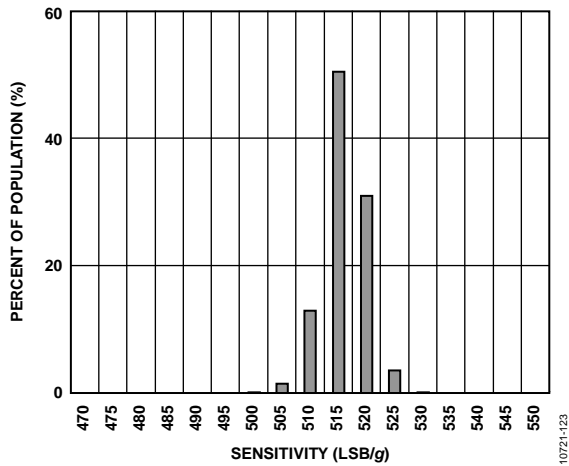

Figure 24. Z-Axis Sensitivity at 25°C,  $V_s = 2.5 V$ , Full Resolution

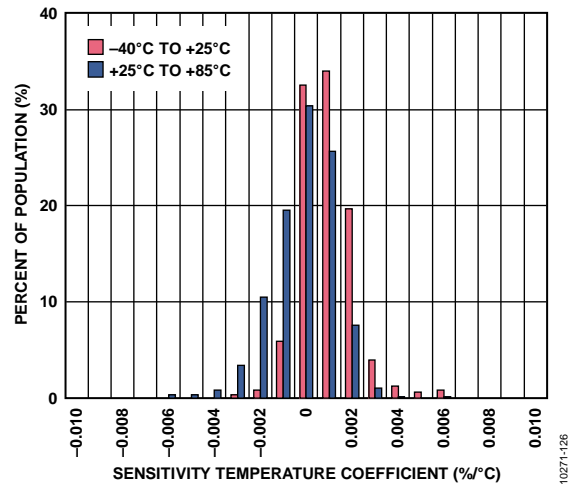

Figure 27. Z-Axis Sensitivity Temperature Coefficient,  $V_s = 2.5 V$

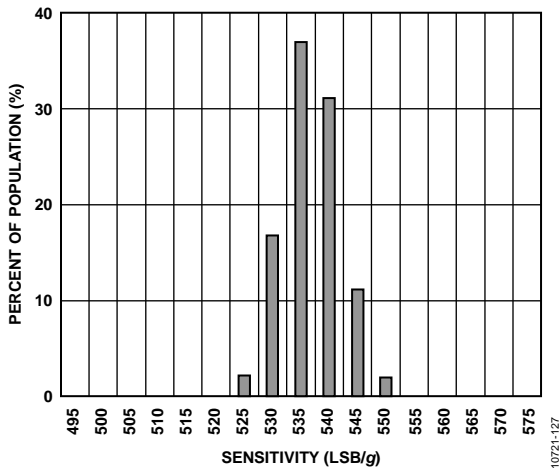

Figure 28. X-Axis Sensitivity,  $V_S = 3.0V$ , Full Resolution

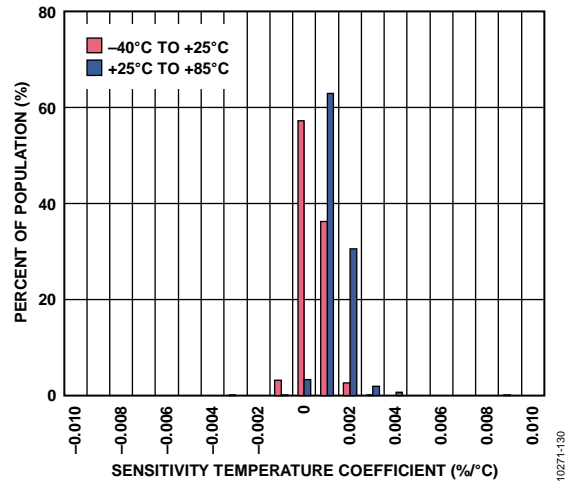

Figure 31. X-Axis Sensitivity Temperature Coefficient,  $V_S = 3.0V$

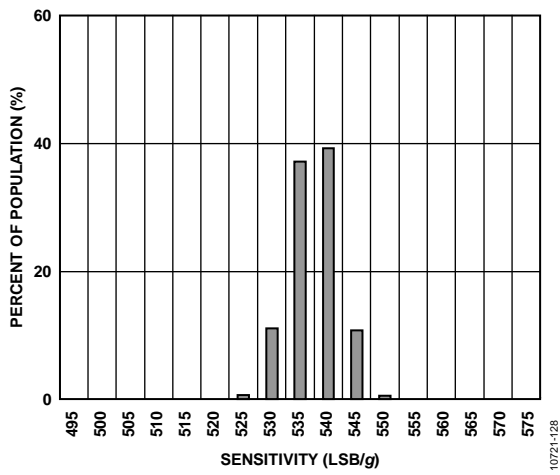

Figure 29. Y-Axis Sensitivity,  $V_S = 3.0V$ , Full Resolution

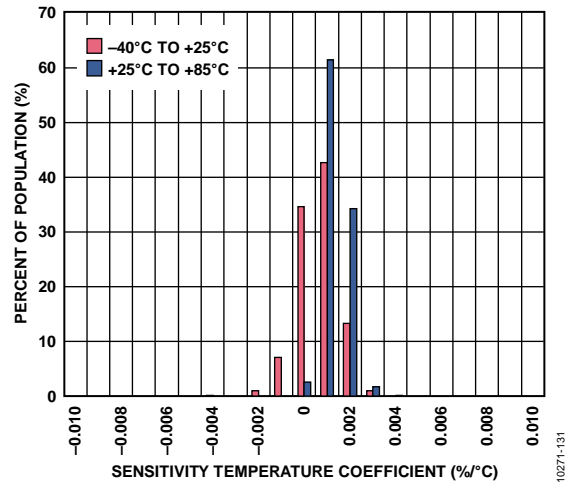

Figure 32. Y-Axis Sensitivity Temperature Coefficient,  $V_S = 3.0V$

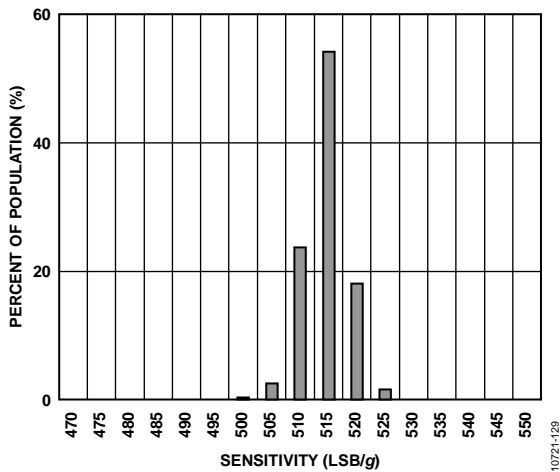

Figure 30. Z-Axis Sensitivity,  $V_S = 3.0V$ , Full Resolution

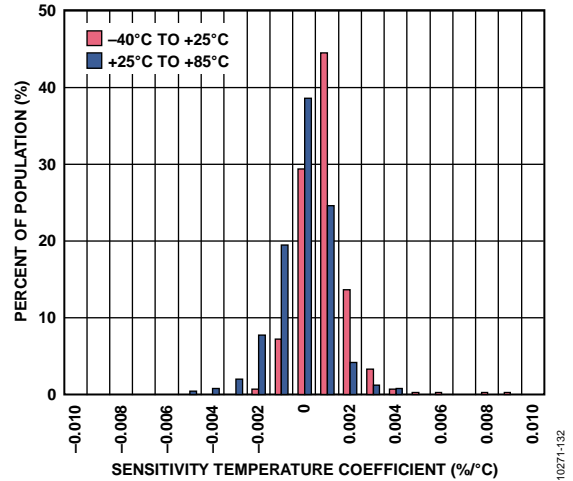

Figure 33. Z-Axis Sensitivity Temperature Coefficient,  $V_S = 3.0V$

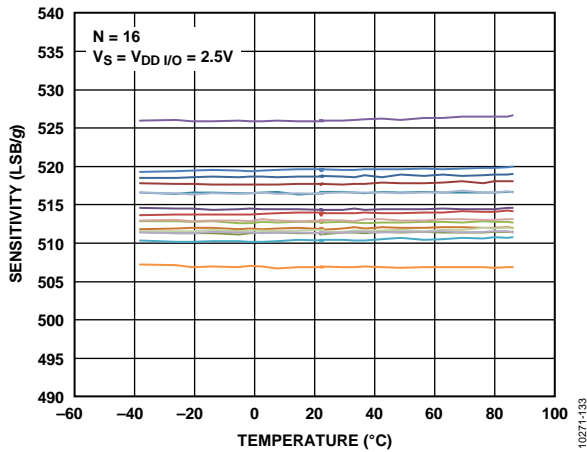

Figure 34. X-Axis Sensitivity vs. Temperature—  
16 Parts Soldered to PCB,  $V_S = 2.5\text{ V}$ , Full Resolution

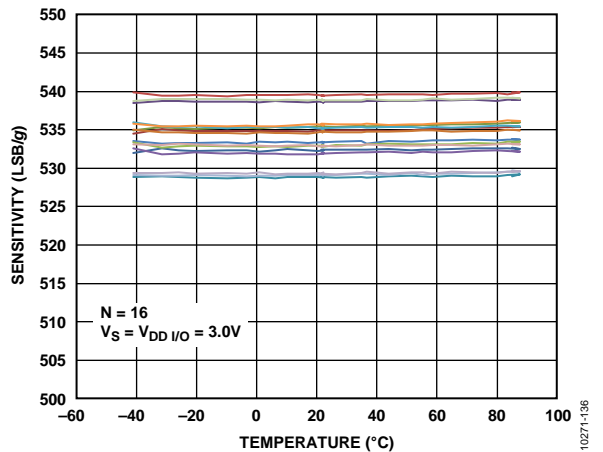

Figure 37. X-Axis Sensitivity vs. Temperature—  
16 Parts Soldered to PCB,  $V_S = 3.0\text{ V}$ , Full Resolution

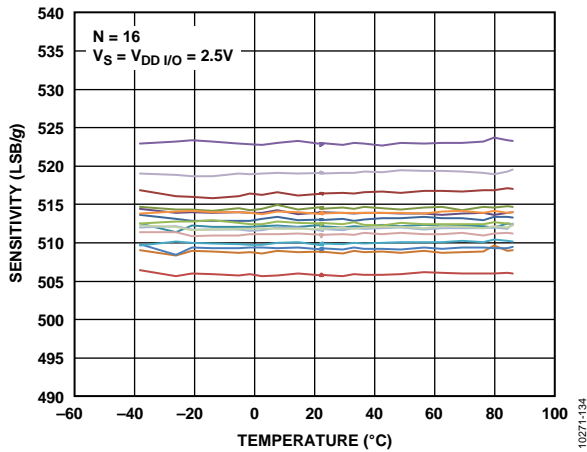

Figure 35. Y-Axis Sensitivity vs. Temperature—  
16 Parts Soldered to PCB,  $V_S = 2.5\text{ V}$ , Full Resolution

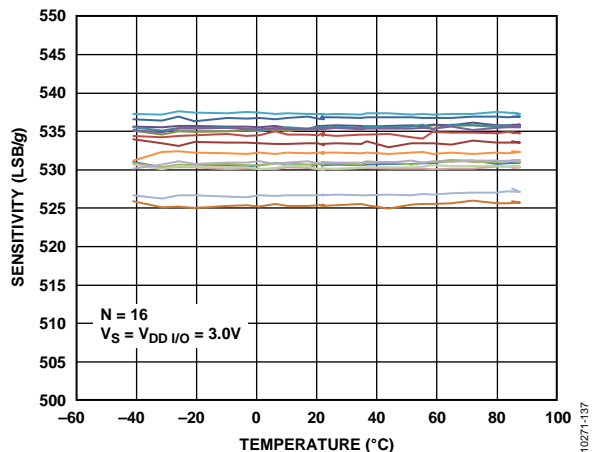

Figure 38. Y-Axis Sensitivity vs. Temperature—  
16 Parts Soldered to PCB,  $V_S = 3.0\text{ V}$ , Full Resolution

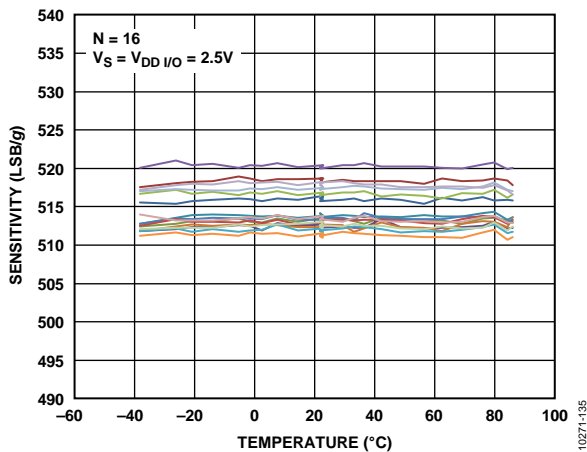

Figure 36. Z-Axis Sensitivity vs. Temperature—  
16 Parts Soldered to PCB,  $V_S = 2.5\text{ V}$ , Full Resolution

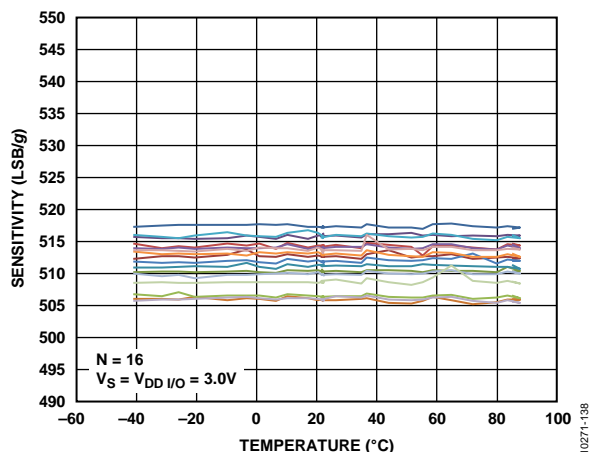

Figure 39. Z-Axis Sensitivity vs. Temperature—  
16 Parts Soldered to PCB,  $V_S = 3.0\text{ V}$ , Full Resolution

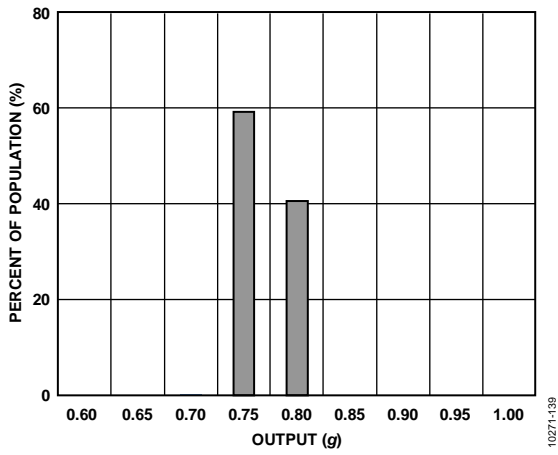

Figure 40. X-Axis Self-Test Response at 25°C,  $V_S = 2.5 V$

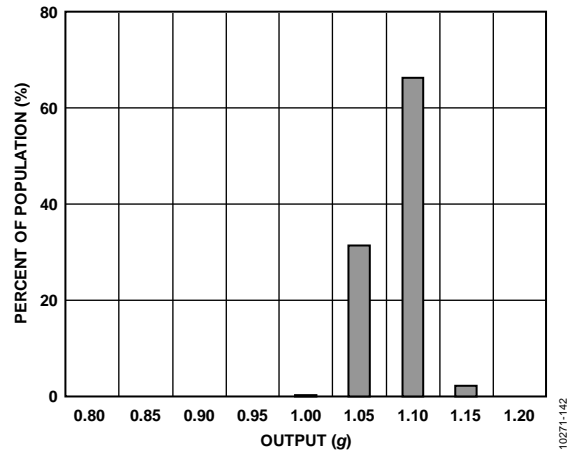

Figure 43. X-Axis Self-Test Response at 25°C,  $V_S = 3.0 V$

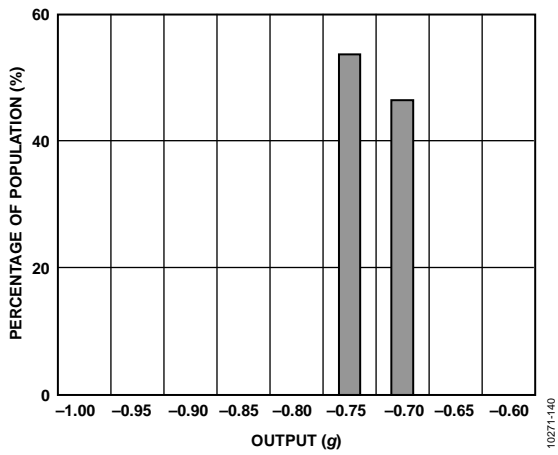

Figure 41. Y-Axis Self-Test Response at 25°C,  $V_S = 2.5 V$

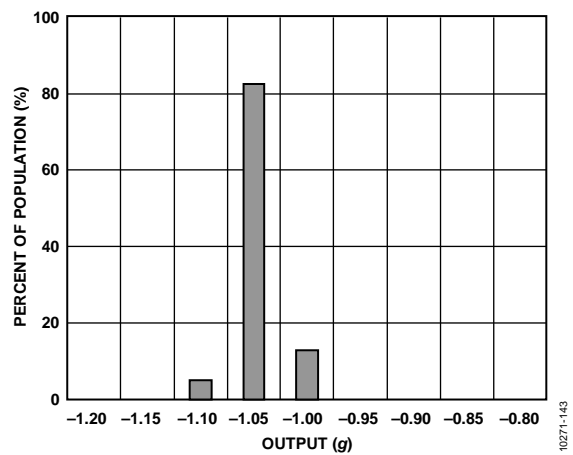

Figure 44. Y-Axis Self-Test Response at 25°C,  $V_S = 3.0 V$

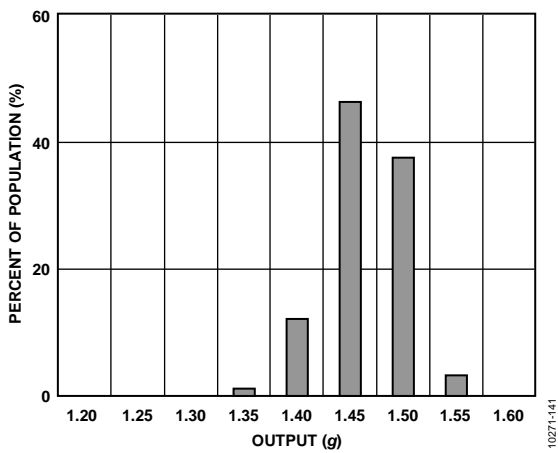

Figure 42. Z-Axis Self-Test Response at 25°C,  $V_S = 2.5 V$

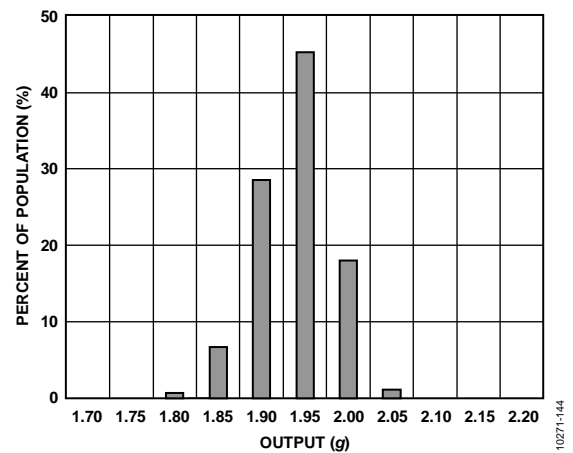

Figure 45. Z-Axis Self-Test Response at 25°C,  $V_S = 3.0 V$

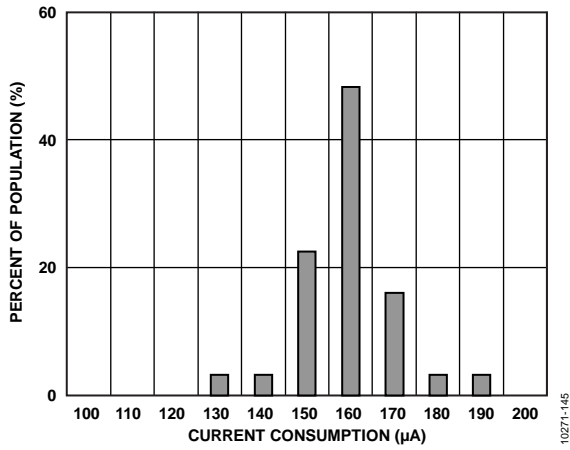

Figure 46. Current Consumption at 25°C, 100 Hz Output Data Rate,  $V_S = 2.5\text{ V}$ , 31 Parts

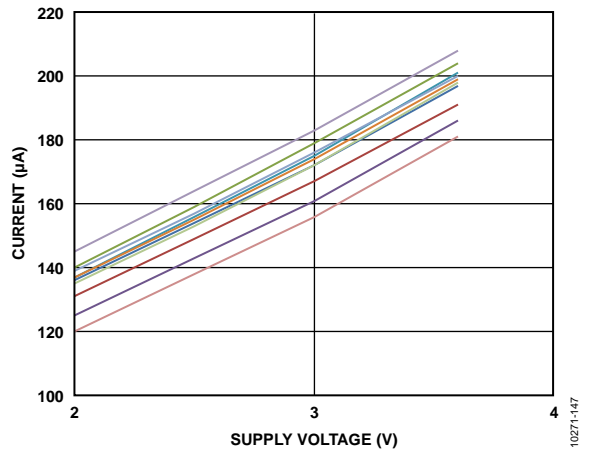

Figure 48. Supply Current vs. Supply Voltage,  $V_S$  at 25°C, 10 Parts

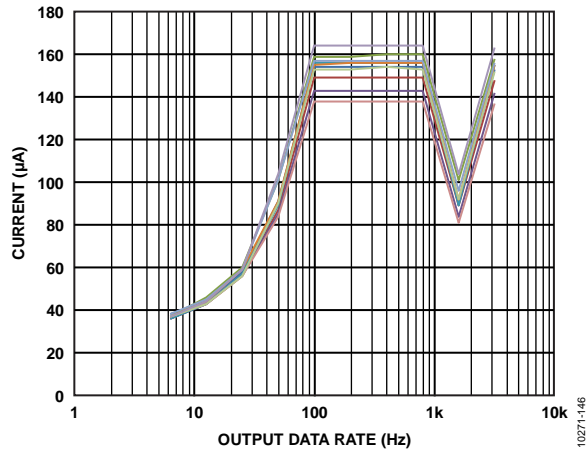

Figure 47. Current Consumption vs. Output Data Rate at 25°C  $V_S = 2.5\text{ V}$ , 10 Parts

## THEORY OF OPERATION

The ADXL350 is a complete 3-axis acceleration measurement system with a selectable measurement range of  $\pm 1 g$ ,  $\pm 2 g$ ,  $\pm 4 g$ , or  $\pm 8 g$ . It measures both dynamic acceleration resulting from motion or shock and static acceleration, such as gravity, which allows the device to be used as a tilt sensor.

The sensor is a polysilicon surface-micromachined structure built on top of a silicon wafer. Polysilicon springs suspend the structure over the surface of the wafer and provide a resistance against acceleration forces.

Deflection of the structure is measured using differential capacitors that consist of independent fixed plates and plates attached to the moving mass. Acceleration deflects the beam and unbalances the differential capacitor, resulting in a sensor output whose amplitude is proportional to acceleration. Phase-sensitive demodulation is used to determine the magnitude and polarity of the acceleration.

## POWER SEQUENCING

Power can be applied to  $V_S$  or  $V_{DD/I/O}$  in any sequence without damaging the ADXL350. All possible power-on modes are summarized in Table 6.

The interface voltage level is set with the interface supply voltage,  $V_{DD/I/O}$ , which must be present to ensure that the ADXL350 does not create a conflict on the communication bus. For single-supply operation,  $V_{DD/I/O}$  can be the same as the main supply,  $V_S$ . In a dual-supply application, however,  $V_{DD/I/O}$  can differ from  $V_S$  to accommodate the desired interface voltage, as long as  $V_S$  is greater than  $V_{DD/I/O}$ .

After  $V_S$  is applied, the device enters standby mode, where power consumption is minimized and the device waits for  $V_{DD/I/O}$  to be applied and for the command to enter measurement mode to be received. (This command can be initiated by setting the measure bit in the POWER\_CTL register (Address 0x2D).) In addition, any register can be written to or read from to configure the part while the device is in standby mode. It is recommended to configure the device in standby mode and then to enable measurement mode. Clearing the measure bit returns the device to the standby mode.

**Table 6. Power Sequencing**

Condition	$V_S$	$V_{DD/I/O}$	Description
Power Off	Off	Off	The device is completely off, but there is the potential for a communication bus conflict.
Bus Disabled	On	Off	The device is on in standby mode, but communication is unavailable and creates a conflict on the communication bus. The duration of this state should be minimized during power-up to prevent a conflict.
Bus Enabled	Off	On	No functions are available, but the device does not create a conflict on the communication bus.
Standby or Measurement	On	On	At power-up, the device is in standby mode, awaiting a command to enter measurement mode, and all sensor functions are off. After the device is instructed to enter measurement mode, all sensor functions are available.

## POWER SAVINGS

### Power Modes

The ADXL350 automatically modulates its power consumption in proportion to its output data rate, as outlined in Table 7. If additional power savings is desired, a lower power mode is available. In this mode, the internal sampling rate is reduced, allowing for power savings in the 12.5 Hz to 400 Hz data rate range but at the expense of slightly greater noise.

To enter lower power mode, set the LOW\_POWER bit (Bit 4) in the BW\_RATE register (Address 0x2C). The current consumption in low power mode is shown in Table 8 for cases where there is an advantage for using low power mode. The current consumption values shown in Table 7 and Table 8 are for a  $V_S$  of 2.5 V. Current scales linearly with  $V_S$ .

**Table 7. Current Consumption vs. Data Rate**  
( $T_A = 25^\circ\text{C}$ ,  $V_S = 2.5\text{ V}$ ,  $V_{DDIO} = 1.8\text{ V}$ )

Output Data Rate (Hz)	Bandwidth (Hz)	Rate Code	$I_{DD}$ ( $\mu\text{A}$ )
3200	1600	1111	145
1600	800	1110	100
800	400	1101	145
400	200	1100	145
200	100	1011	145
100	50	1010	145
50	25	1001	100
25	12.5	1000	65
12.5	6.25	0111	55
6.25	3.125	0110	40

**Table 8. Current Consumption vs. Data Rate, Low Power Mode**  
( $T_A = 25^\circ\text{C}$ ,  $V_S = 2.5\text{ V}$ ,  $V_{DDIO} = 1.8\text{ V}$ )

Output Data Rate (Hz)	Bandwidth (Hz)	Rate Code	$I_{DD}$ ( $\mu\text{A}$ )
400	200	1100	100
200	100	1011	65
100	50	1010	55
50	25	1001	50
25	12.5	1000	40
12.5	6.25	0111	40

### Auto Sleep Mode

Additional power can be saved if the ADXL350 automatically switches to sleep mode during periods of inactivity. To enable this feature, set the THRESH\_INACT register (Address 0x25) and the TIME\_INACT register (Address 0x26) each to a value that signifies inactivity (the appropriate value depends on the application), and then set the AUTO\_SLEEP bit and the link bit in the POWER\_CTL register (Address 0x2D). Current consumption at the sub-8 Hz data rates used in this mode is typically 40  $\mu\text{A}$  for a  $V_S$  of 2.5 V.

### Standby Mode

For even lower power operation, standby mode can be used. In standby mode, current consumption is reduced to 0.1  $\mu\text{A}$  (typical). In this mode, no measurements are made. Standby mode is entered by clearing the measure bit (Bit 3) in the POWER\_CTL register (Address 0x2D). Placing the device into standby mode preserves the contents of FIFO.



## SERIAL COMMUNICATIONS

I<sup>2</sup>C and SPI digital communications are possible and regardless, the ADXL350 always operates as a slave. I<sup>2</sup>C mode is enabled if the  $\overline{\text{CS}}$  pin is tied high to V<sub>DD I/O</sub>. The  $\overline{\text{CS}}$  pin should always be tied high to V<sub>DD I/O</sub> or be driven by an external controller because there is no default mode if the  $\overline{\text{CS}}$  pin is left unconnected. Not taking this precaution may result in an inability to communicate with the part. In SPI mode, the  $\overline{\text{CS}}$  pin is controlled by the bus master.

In both SPI and I<sup>2</sup>C modes of operation, data transmitted from the ADXL350 to the master device should be ignored during writes to the ADXL350.

### SPI

For SPI, either 3- or 4-wire configuration is possible, as shown in the connection diagrams in Figure 49 and Figure 50. Clearing the SPI bit in the DATA\_FORMAT register (Address 0x31) selects 4-wire mode, whereas setting the SPI bit selects 3-wire mode. The maximum SPI clock speed is 5 MHz with 100 pF maximum loading, and the timing scheme follows clock polarity (CPOL) = 1 and clock phase (CPHA) = 1.

$\overline{\text{CS}}$  is the serial port enable line and is controlled by the SPI master. This line must go low at the start of a transmission and high at the end of a transmission, as shown in Figure 52. SCLK is the serial port clock and is supplied by the SPI master. It is stopped high when  $\overline{\text{CS}}$  is high during a period of no transmission. SDI and SDO are the serial data input and output, respectively. Data should be sampled at the rising edge of SCLK.

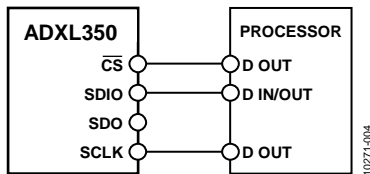

Figure 49. 3-Wire SPI Connection Diagram

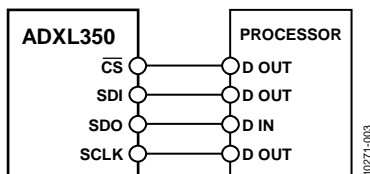

Figure 50. 4-Wire SPI Connection Diagram

To read or write multiple bytes in a single transmission, the multiple-byte bit, located after the R/W bit in the first byte transfer (MB in Figure 52 to Figure 54), must be set. After the register addressing and the first byte of data, each subsequent set of clock pulses (eight clock pulses) causes the ADXL350 to point to the next register for a read or write. This shifting continues until the clock pulses cease and  $\overline{\text{CS}}$  is deasserted. To perform reads or writes on different, nonsequential registers,  $\overline{\text{CS}}$  must be deasserted between transmissions and the new register must be addressed separately. The timing diagram for 3-wire SPI reads or writes is shown in Figure 54. The 4-wire equivalents for SPI writes and reads are shown in Figure 52 and Figure 53, respectively.

### Preventing Bus Traffic Errors

The ADXL350  $\overline{\text{CS}}$  pin is used both for initiating SPI transactions, and for enabling I<sup>2</sup>C mode. When the ADXL350 is used on an SPI bus with multiple devices, its  $\overline{\text{CS}}$  pin is held high while the master communicates with the other devices. There may be conditions where an SPI command transmitted to another device looks like a valid I<sup>2</sup>C command. In this case, the ADXL350 would interpret this as an attempt to communicate in I<sup>2</sup>C mode, and could interfere with other bus traffic. Unless bus traffic can be adequately controlled to assure such a condition never occurs, it is recommended to add a logic gate in front of the SDI pin as shown in Figure 51. This OR gate will hold the SDA line high when  $\overline{\text{CS}}$  is high to prevent SPI bus traffic at the ADXL350 from appearing as an I<sup>2</sup>C start command.

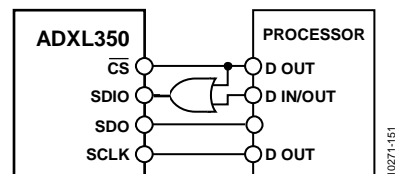

Figure 51. Recommended SPI Connection Diagram when Using Multiple SPI Devices on a Single Bus

Table 9. SPI Digital Input/Output Voltage

Parameter	Test Conditions	Limit <sup>1</sup>		Unit
		Min	Max	
Digital Input				
Low Level Input Voltage ( $V_{IL}$ )			$0.3 \times V_{DD I/O}$	V
High Level Input Voltage ( $V_{IH}$ )		$0.7 \times V_{DD I/O}$		V
Low Level Input Current ( $I_{IL}$ )	$V_{IN} = V_{DD I/O}$		0.1	$\mu$ A
High Level Input Current ( $I_{IH}$ )	$V_{IN} = 0$ V	-0.1		$\mu$ A
Digital Output				
Low Level Output Voltage ( $V_{OL}$ )	$I_{OL} = 10$ mA		$0.2 \times V_{DD I/O}$	V
High Level Output Voltage ( $V_{OH}$ )	$I_{OH} = -4$ mA	$0.8 \times V_{DD I/O}$		V
Low Level Output Current ( $I_{OL}$ )	$V_{OL} = V_{OL, max}$	10		mA
High Level Output Current ( $I_{OH}$ )	$V_{OH} = V_{OH, min}$		-4	mA
Pin Capacitance	$f_{IN} = 1$ MHz, $V_{IN} = 2.5$ V		8	pF

<sup>1</sup> Limits based on characterization results, not production tested.

Table 10. SPI Timing ( $T_A = 25^\circ\text{C}$ ,  $V_S = 2.5$  V,  $V_{DD I/O} = 1.8$  V)<sup>1</sup>

Parameter	Limit <sup>2,3</sup>		Unit	Description
	Min	Max		
$f_{SCLK}$		5	MHz	SPI clock frequency
$t_{SCLK}$	200		ns	1/(SPI clock frequency) mark-space ratio for the SCLK input is 40/60 to 60/40
$t_{DELAY}$	10		ns	$\overline{CS}$ falling edge to SCLK falling edge
$t_{QUIET}$	10		ns	SCLK rising edge to $\overline{CS}$ rising edge
$t_{DIS}$		100	ns	$\overline{CS}$ rising edge to SDO disabled
$t_{CS,DIS}$	250		ns	$\overline{CS}$ deassertion between SPI communications
$t_S$	$0.4 \times t_{SCLK}$		ns	SCLK low pulse width (space)
$t_M$	$0.4 \times t_{SCLK}$		ns	SCLK high pulse width (mark)
$t_{SDO}$		95	ns	SCLK falling edge to SDO transition
$t_{SETUP}$	10		ns	SDI valid before SCLK rising edge
$t_{HOLD}$	10		ns	SDI valid after SCLK rising edge

<sup>1</sup> The  $\overline{CS}$ , SCLK, SDI, and SDO pins are not internally pulled up or down; they must be driven for proper operation.

<sup>2</sup> Limits are based on characterization results, characterized with  $f_{SCLK} = 5$  MHz and bus load capacitance of 100 pF; not production tested.

<sup>3</sup> The timing values are measured corresponding to the input thresholds ( $V_{IL}$  and  $V_{IH}$ ) given in Table 9.

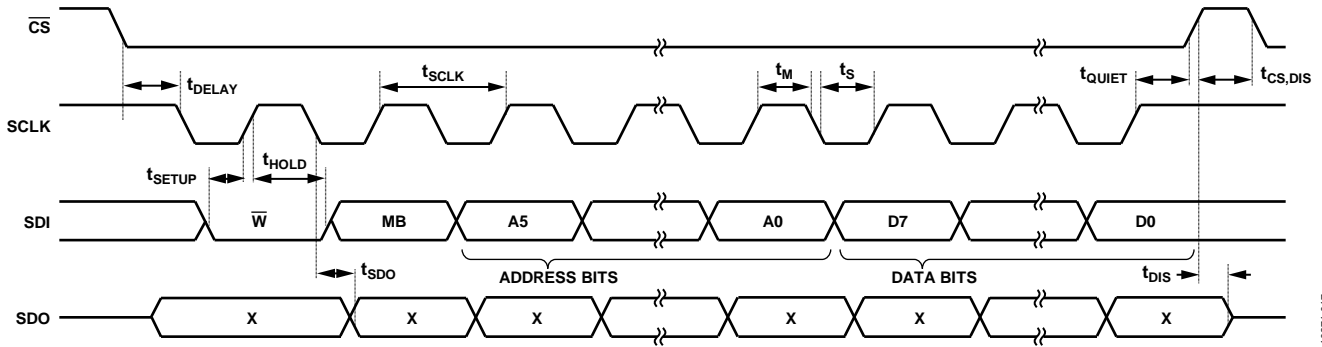

Figure 52. SPI 4-Wire Write

10271-017

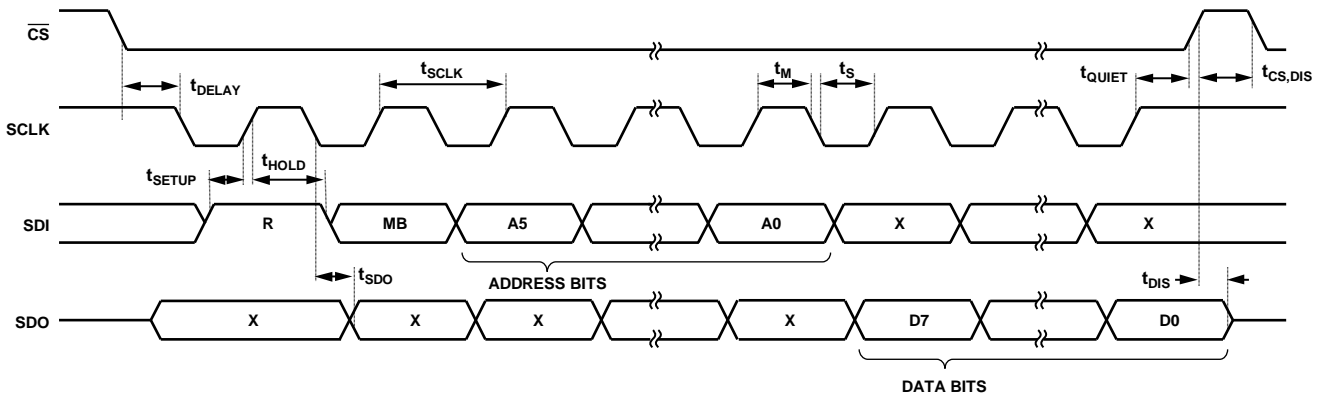
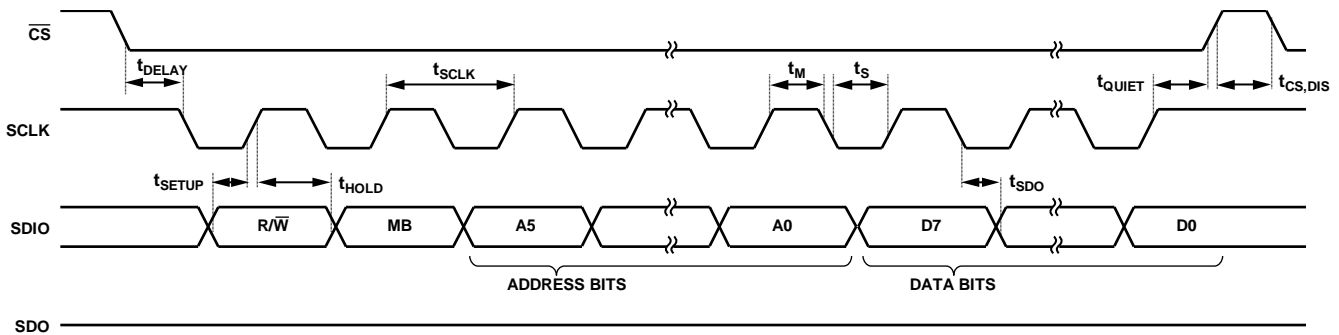

Figure 53. SPI 4-Wire Read

10271-018



NOTES  
 1.  $t_{SDO}$  IS ONLY PRESENT DURING READS.

Figure 54. SPI 3-Wire Read/Write

10271-019

I<sup>2</sup>C

With  $\overline{CS}$  tied high to  $V_{DD1/O}$ , the ADXL350 is in I<sup>2</sup>C mode, requiring a simple 2-wire connection as shown in Figure 55. The ADXL350 conforms to the UM10204 I<sup>2</sup>C-Bus Specification and User Manual, Rev. 03—19 June 2007, available from NXP Semiconductor. It supports standard (100 kHz) and fast (400 kHz) data transfer modes if the timing parameters given in Table 12 and Figure 57 are met.

Single-byte or multiple-byte reads/writes are supported, as shown in Figure 56. With the SDO/ALT ADDRESS pin (Pin 7) high, the 7-bit I<sup>2</sup>C address for the device is 0x1D, followed by the R/W bit. This translates to 0x3A for a write and 0x3B for a read. An alternate I<sup>2</sup>C address of 0x53 (followed by the R/W bit) can be chosen by grounding the SDO/ALT ADDRESS pin (Pin 7). This translates to 0xA6 for a write and 0xA7 for a read.

If other devices are connected to the same I<sup>2</sup>C bus, the nominal operating voltage level of these other devices cannot exceed  $V_{DD1/O}$  by more than 0.3 V. External pull-up resistors,  $R_p$ , are necessary for proper I<sup>2</sup>C operation. Refer to the UM10204 I<sup>2</sup>C-Bus Specification and User Manual, Rev. 03—19 June 2007, when selecting pull-up resistor values to ensure proper operation.

Table 11. I<sup>2</sup>C Digital Input/Output Voltage

Parameter	Limit <sup>1</sup>	Unit
Digital Input Voltage		
Low Level Input Voltage ( $V_{IL}$ )	$0.25 \times V_{DD1/O}$	V max
High Level Input Voltage ( $V_{IH}$ )	$0.75 \times V_{DD1/O}$	V min
Digital Output Voltage		
Low Level Output Voltage ( $V_{OL}$ ) <sup>2</sup>	$0.2 \times V_{DD1/O}$	V max

<sup>1</sup> Limits are based on characterization results; not production tested.  
<sup>2</sup> The limit given is only for  $V_{DD1/O} < 2$  V. When  $V_{DD1/O} > 2$  V, the limit is 0.4 V maximum.

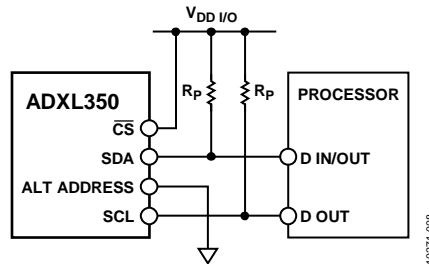
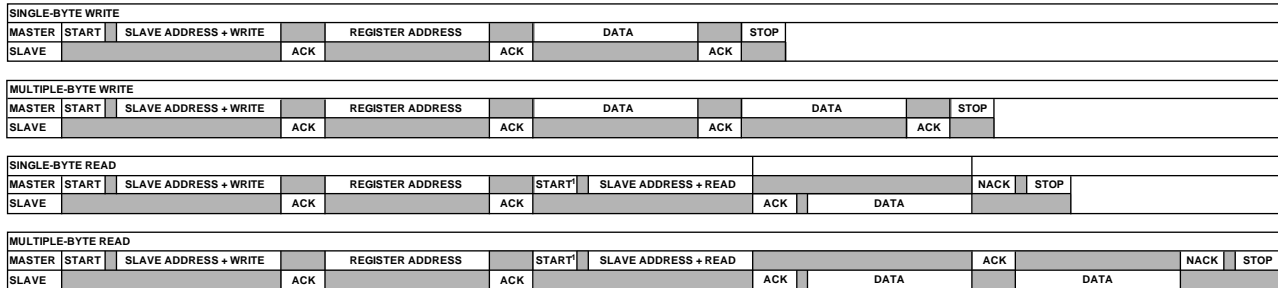

Figure 55. I<sup>2</sup>C Connection Diagram (Address 0x53)



NOTES

1. THIS START IS EITHER A RESTART OR A STOP FOLLOWED BY A START.
2. THE SHADED AREAS REPRESENT WHEN THE DEVICE IS LISTENING.

Figure 56. I<sup>2</sup>C Device Addressing

Table 12. I<sup>2</sup>C Timing (T<sub>A</sub> = 25°C, V<sub>S</sub> = 2.5 V, V<sub>DD1/O</sub> = 1.8 V)

Parameter	Limit <sup>1, 2</sup>		Unit	Description
	Min	Max		
f <sub>SCL</sub>		400	kHz	SCL clock frequency
t <sub>1</sub>	2.5		μs	SCL cycle time
t <sub>2</sub>	0.6		μs	t <sub>HIGH</sub> , SCL high time
t <sub>3</sub>	1.3		μs	t <sub>LOW</sub> , SCL low time
t <sub>4</sub>	0.6		μs	t <sub>HD, STAR</sub> , start/repeated start condition hold time
t <sub>5</sub>	350		ns	t <sub>SU, DAT</sub> , data setup time
t <sub>6</sub> <sup>3, 4, 5, 6</sup>	0	0.65	μs	t <sub>HD, DAT</sub> , data hold time
t <sub>7</sub>	0.6		μs	t <sub>SU, STAR</sub> , setup time for repeated start
t <sub>8</sub>	0.6		μs	t <sub>SU, STOP</sub> , stop condition setup time
t <sub>9</sub>	1.3		μs	t <sub>BUF</sub> , bus-free time between a stop condition and a start condition
t <sub>10</sub>		300	ns	t <sub>R</sub> , rise time of both SCL and SDA when receiving
	0		ns	t <sub>R</sub> , rise time of both SCL and SDA when receiving or transmitting
t <sub>11</sub>		250	ns	t <sub>F</sub> , fall time of SDA when receiving
		300	ns	t <sub>F</sub> , fall time of both SCL and SDA when transmitting
	20 + 0.1 C <sub>b</sub> <sup>7</sup>		ns	t <sub>F</sub> , fall time of both SCL and SDA when transmitting or receiveing
C <sub>b</sub>		400	pF	Capacitive load for each bus line

<sup>1</sup> Limits are based on characterization results, with f<sub>SCL</sub> = 400 kHz and a 3 mA sink current; not production tested.

<sup>2</sup> All values are referred to the V<sub>IH</sub> and the V<sub>IL</sub> levels given in Table 11.

<sup>3</sup> t<sub>6</sub> is the data hold time that is measured from the falling edge of SCL. It applies to data in transmission and acknowledge times.

<sup>4</sup> A transmitting device must internally provide an output hold time of at least 300 ns for the SDA signal (with respect to V<sub>IH(min)</sub> of the SCL signal) to bridge the undefined region of the falling edge of SCL.

<sup>5</sup> The maximum t<sub>6</sub> value must be met only if the device does not stretch the low period (t<sub>3</sub>) of the SCL signal.

<sup>6</sup> The maximum value for t<sub>6</sub> is a function of the clock low time (t<sub>3</sub>), the clock rise time (t<sub>10</sub>), and the minimum data setup time (t<sub>S(min)</sub>). This value is calculated as t<sub>6(max)</sub> = t<sub>3</sub> - t<sub>10</sub> - t<sub>S(min)</sub>.

<sup>7</sup> C<sub>b</sub> is the total capacitance of one bus line in picofarads.

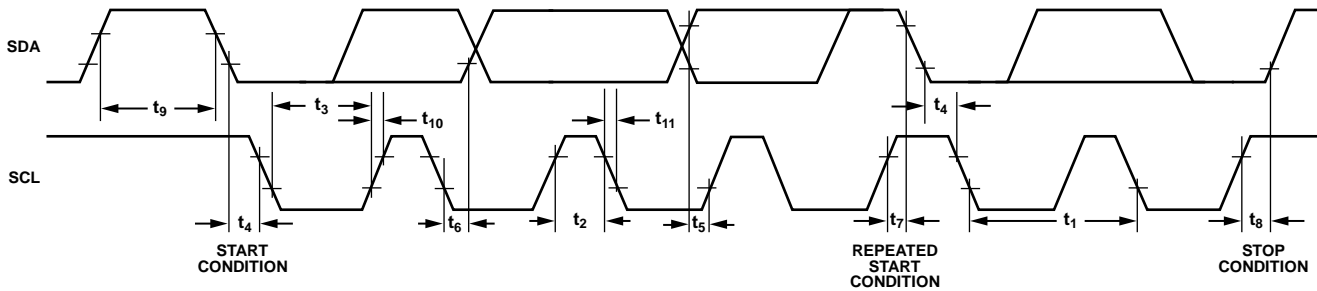

Figure 57. I<sup>2</sup>C Timing Diagram

10271-020

## INTERRUPTS

The ADXL350 provides two output pins for driving interrupts: INT1 and INT2. Each interrupt function is described in detail in this section. All functions can be used simultaneously, with the only limiting feature being that some functions may need to share interrupt pins. Interrupts are enabled by setting the appropriate bit in the INT\_ENABLE register (Address 0x2E) and are mapped to either the INT1 or INT2 pin based on the contents of the INT\_MAP register (Address 0x2F). It is recommended that interrupt bits be configured with the interrupts disabled, preventing interrupts from being accidentally triggered during configuration. This can be done by writing a value of 0x00 to the INT\_ENABLE register.

Clearing interrupts is performed either by reading the data registers (Address 0x32 to Address 0x37) until the interrupt condition is no longer valid for the data-related interrupts or by reading the INT\_SOURCE register (Address 0x30) for the remaining interrupts. This section describes the interrupts that can be set in the INT\_ENABLE register and monitored in the INT\_SOURCE register.

### DATA\_READY

The DATA\_READY bit is set when new data is available and is cleared when no new data is available.

### SINGLE\_TAP

The SINGLE\_TAP bit is set when a single acceleration event that is greater than the value in the THRESH\_TAP register (Address 0x1D) occurs for less time than is specified in the DUR register (Address 0x21).

### DOUBLE\_TAP

The DOUBLE\_TAP bit is set when two acceleration events that are greater than the value in the THRESH\_TAP register (Address 0x1D) occur for less time than is specified in the DUR register (Address 0x21), with the second tap starting after the time specified by the latent register (Address 0x22) but within the time specified in the window register (Address 0x23). See the Tap Detection section for more details.

### Activity

The activity bit is set when acceleration greater than the value stored in the THRESH\_ACT register (Address 0x24) is experienced.

### Inactivity

The inactivity bit is set when acceleration of less than the value stored in the THRESH\_INACT register (Address 0x25) is experienced for more time than is specified in the TIME\_INACT register (Address 0x26). The maximum value for TIME\_INACT is 255 sec.

### FREE\_FALL

The FREE\_FALL bit is set when acceleration of less than the value stored in the THRESH\_FF register (Address 0x28) is experienced for more time than is specified in the TIME\_FF

register (Address 0x29). The FREE\_FALL interrupt differs from the inactivity interrupt as follows: all axes always participate, the timer period is much smaller (1.28 sec maximum), and the mode of operation is always dc-coupled.

### Watermark

The watermark bit is set when the number of samples in FIFO equals the value stored in the samples bits (Register FIFO\_CTL, Address 0x38). The watermark bit is cleared automatically when FIFO is read, and the content returns to a value below the value stored in the samples bits.

### Overrun

The overrun bit is set when new data replaces unread data. The precise operation of the overrun function depends on the FIFO mode. In bypass mode, the overrun bit is set when new data replaces unread data in the DATA\_X, DATA\_Y, and DATA\_Z registers (Address 0x32 to Address 0x37). In all other modes, the overrun bit is set when FIFO is filled. The overrun bit is automatically cleared when the contents of FIFO are read.

### FIFO

The ADXL350 contains patent pending technology for an embedded 32-level FIFO that can be used to minimize host processor burden. This buffer has four modes: bypass, FIFO, stream, and trigger (see Table 20). Each mode is selected by the settings of the FIFO\_MODE bits in the FIFO\_CTL register (Address 0x38).

### Bypass Mode

In bypass mode, FIFO is not operational and, therefore, remains empty.

### FIFO Mode

In FIFO mode, data from measurements of the x-, y-, and z-axes are stored in FIFO. When the number of samples in FIFO equals the level specified in the samples bits of the FIFO\_CTL register (Address 0x38), the watermark interrupt is set. FIFO continues accumulating samples until it is full (32 samples from measurements of the x-, y-, and z-axes) and then stops collecting data. After FIFO stops collecting data, the device continues to operate; therefore, features such as tap detection can be used after FIFO is full. The watermark interrupt continues to occur until the number of samples in FIFO is less than the value stored in the samples bits of the FIFO\_CTL register.

### Stream Mode

In stream mode, data from measurements of the x-, y-, and z-axes are stored in FIFO. When the number of samples in FIFO equals the level specified in the samples bits of the FIFO\_CTL register (Address 0x38), the watermark interrupt is set. FIFO continues accumulating samples and holds the latest 32 samples from measurements of the x-, y-, and z-axes, discarding older data as new data arrives. The watermark interrupt continues occurring until the number of samples in FIFO is less than the value stored in the samples bits of the FIFO\_CTL register.

### Trigger Mode

In trigger mode, FIFO accumulates samples, holding the latest 32 samples from measurements of the x-, y-, and z-axes. After a trigger event occurs and an interrupt is sent to the INT1 or INT2 pin (determined by the trigger bit in the FIFO\_CTL register), FIFO keeps the last n samples (where n is the value specified by the samples bits in the FIFO\_CTL register) and then operates in FIFO mode, collecting new samples only when FIFO is not full.

A delay of at least 5  $\mu$ s should be present between the trigger event occurring and the start of reading data from the FIFO to allow the FIFO to discard and retain the necessary samples. Additional trigger events cannot be recognized until the trigger mode is reset. To reset the trigger mode, set the device to bypass mode and then set the device back to trigger mode. Note that the FIFO data should be read first because placing the device into bypass mode clears FIFO.

### Retrieving Data from FIFO

The FIFO data is read through the DATA\_X, DATA\_Y, and DATA\_Z registers (Address 0x32 to Address 0x37). When the FIFO is in FIFO, stream, or trigger mode, reads to the DATA\_X, DATA\_Y, and DATA\_Z registers read data stored in the FIFO. Each time data is read from the FIFO, the oldest x-, y-, and z-axes data are placed into the DATA\_X, DATA\_Y, and DATA\_Z registers.

If a single-byte read operation is performed, the remaining bytes of data for the current FIFO sample are lost. Therefore, all axes of interest should be read in a burst (or multiple-byte) read operation. To ensure that the FIFO has completely popped (that is, that new data has completely moved into the DATA\_X, DATA\_Y, and DATA\_Z registers), there must be at least 5  $\mu$ s between the end of reading the data registers and the start of a new read of the FIFO or a read of the FIFO\_STATUS register (Address 0x39). The end of reading a data register is signified by the transition from Register 0x37 to Register 0x38 or by the CS pin going high.

For SPI operation at 1.6 MHz or less, the register addressing portion of the transmission is a sufficient delay to ensure that the FIFO has completely popped. For SPI operation greater than 1.6 MHz, it is necessary to deassert the CS pin to ensure a total delay of 5  $\mu$ s; otherwise, the delay will not be sufficient. The total delay necessary for 5 MHz operation is at most 3.4  $\mu$ s. This is not a concern when using I<sup>2</sup>C mode because the communication rate is low enough to ensure a sufficient delay between FIFO reads.

### SELF-TEST

The ADXL350 incorporates a self-test feature that effectively tests its mechanical and electronic systems simultaneously. When the self-test function is enabled (via the SELF\_TEST bit in the DATA\_FORMAT register, Address 0x31), an electrostatic force is exerted on the mechanical sensor. This electrostatic force moves the mechanical sensing element in the same manner as acceleration, and it is additive to the acceleration experienced by the device. This added electrostatic force results in an output change in the x-, y-, and z-axes. Because the electrostatic force is proportional to  $V_s^2$ , the output change varies with  $V_s$ .

The self-test feature of the ADXL350 also exhibits a bimodal behavior that depends on which phase of the clock self-test is enabled. However, the limits shown in Table 1 and Table 13 to Table 16 are valid for all potential self-test values across the entire allowable voltage range. Use of the self-test feature at data rates less than 100 Hz may yield values outside these limits. Therefore, the part should be placed into a data rate of 100 Hz or greater when using self-test.

**Table 13. Self-Test Output in LSB for  $\pm 1$  g, 10-bit Resolution or any g-Range, Full Resolution**

Axis	Min	Max	Unit
X	100	1180	LSB
Y	-1180	-100	LSB
Z	150	1850	LSB

**Table 14. Self-Test Output in LSB for  $\pm 2$  g, 10-Bit Resolution**

Axis	Min	Max	Unit
X	50	590	LSB
Y	-590	-50	LSB
Z	75	925	LSB

**Table 15. Self-Test Output in LSB for  $\pm 4$  g, 10-Bit Resolution**

Axis	Min	Max	Unit
X	25	295	LSB
Y	-295	-25	LSB
Z	38	463	LSB

**Table 16. Self-Test Output in LSB for  $\pm 8$  g, 10-Bit Resolution**

Axis	Min	Max	Unit
X	12	148	LSB
Y	-148	-12	LSB
Z	19	232	LSB

## REGISTER MAP

Table 17. Register Map

Address		Name	Type	Reset Value	Description
Hex	Dec				
0x00	0	DEVID	R	11100101	Device ID.
0x01 to 0x01C	1 to 28	Reserved			Reserved. Do not access.
0x1D	29	THRESH_TAP	R/ $\bar{W}$	00000000	Tap threshold.
0x1E	30	OFSX	R/ $\bar{W}$	00000000	X-axis offset.
0x1F	31	OFSY	R/ $\bar{W}$	00000000	Y-axis offset.
0x20	32	OFSZ	R/ $\bar{W}$	00000000	Z-axis offset.
0x21	33	DUR	R/ $\bar{W}$	00000000	Tap duration.
0x22	34	Latent	R/ $\bar{W}$	00000000	Tap latency.
0x23	35	Window	R/ $\bar{W}$	00000000	Tap window.
0x24	36	THRESH_ACT	R/ $\bar{W}$	00000000	Activity threshold.
0x25	37	THRESH_INACT	R/ $\bar{W}$	00000000	Inactivity threshold.
0x26	38	TIME_INACT	R/ $\bar{W}$	00000000	Inactivity time.
0x27	39	ACT_INACT_CTL	R/ $\bar{W}$	00000000	Axis enable control for activity and inactivity detection.
0x28	40	THRESH_FF	R/ $\bar{W}$	00000000	Free-fall threshold.
0x29	41	TIME_FF	R/ $\bar{W}$	00000000	Free-fall time.
0x2A	42	TAP_AXES	R/ $\bar{W}$	00000000	Axis control for tap/double tap.
0x2B	43	ACT_TAP_STATUS	R	00000000	Source of tap/double tap.
0x2C	44	BW_RATE	R/ $\bar{W}$	00001010	Data rate and power mode control.
0x2D	45	POWER_CTL	R/ $\bar{W}$	00000000	Power-saving features control.
0x2E	46	INT_ENABLE	R/ $\bar{W}$	00000000	Interrupt enable control.
0x2F	47	INT_MAP	R/ $\bar{W}$	00000000	Interrupt mapping control.
0x30	48	INT_SOURCE	R	00000010	Source of interrupts.
0x31	49	DATA_FORMAT	R/ $\bar{W}$	00000000	Data format control.
0x32	50	DATA0	R	00000000	X-Axis Data 0.
0x33	51	DATA1	R	00000000	X-Axis Data 1.
0x34	52	DATA0	R	00000000	Y-Axis Data 0.
0x35	53	DATA1	R	00000000	Y-Axis Data 1.
0x36	54	DATA0	R	00000000	Z-Axis Data 0.
0x37	55	DATA1	R	00000000	Z-Axis Data 1.
0x38	56	FIFO_CTL	R/ $\bar{W}$	00000000	FIFO control.
0x39	57	FIFO_STATUS	R	00000000	FIFO status.



**REGISTER DEFINITIONS****Register 0x00—DEVID (Read Only)**

D7	D6	D5	D4	D3	D2	D1	D0
1	1	1	0	0	1	0	1

The DEVID register holds a fixed device ID code of 0xE5 (345 octal).

**Register 0x1D—THRESH\_TAP (Read/Write)**

The THRESH\_TAP register is eight bits and holds the threshold value for tap interrupts. The data format is unsigned, so the magnitude of the tap event is compared with the value in THRESH\_TAP. The scale factor is 31.2 mg/LSB (that is, 0xFF = +8 g). A value of 0 may result in undesirable behavior if tap/double tap interrupts are enabled.

**Register 0x1E, Register 0x1F, Register 0x20—OFSX, OFSY, OFSZ (Read/Write)**

The OFSX, OFSY, and OFSZ registers are each eight bits and offer user-set offset adjustments in twos complement format with a scale factor of 7.8 mg/LSB (that is, 0x7F = +1 g).

**Register 0x21—DUR (Read/Write)**

The DUR register is eight bits and contains an unsigned time value representing the maximum time that an event must be above the THRESH\_TAP threshold to qualify as a tap event. The scale factor is 625  $\mu$ s/LSB. A value of 0 disables the tap/double tap functions.

**Register 0x22—Latent (Read/Write)**

The latent register is eight bits and contains an unsigned time value representing the wait time from the detection of a tap event to the start of the time window (defined by the window register) during which a possible second tap event can be detected. The scale factor is 1.25 ms/LSB. A value of 0 disables the double tap function.

**Register 0x23—Window (Read/Write)**

The window register is eight bits and contains an unsigned time value representing the amount of time after the expiration of the latency time (determined by the latent register) during which a second valid tap can begin. The scale factor is 1.25 ms/LSB. A value of 0 disables the double tap function.

**Register 0x24—THRESH\_ACT (Read/Write)**

The THRESH\_ACT register is eight bits and holds the threshold value for detecting activity. The data format is unsigned, so the magnitude of the activity event is compared with the value in the THRESH\_ACT register. The scale factor is 31.2 mg/LSB. A value of 0 may result in undesirable behavior if the activity interrupt is enabled.

**Register 0x25—THRESH\_INACT (Read/Write)**

The THRESH\_INACT register is eight bits and holds the threshold value for detecting inactivity. The data format is unsigned, so the magnitude of the inactivity event is compared with the value in the THRESH\_INACT register. The scale factor is 31.2 mg/LSB.

A value of 0 mg may result in undesirable behavior if the inactivity interrupt is enabled.

**Register 0x26—TIME\_INACT (Read/Write)**

The TIME\_INACT register is eight bits and contains an unsigned time value representing the amount of time that acceleration must be less than the value in the THRESH\_INACT register for inactivity to be declared. The scale factor is 1 sec/LSB. Unlike the other interrupt functions, which use unfiltered data (see the Threshold section), the inactivity function uses filtered output data. At least one output sample must be generated for the inactivity interrupt to be triggered. This results in the function appearing unresponsive if the TIME\_INACT register is set to a value less than the time constant of the output data rate. A value of 0 results in an interrupt when the output data is less than the value in the THRESH\_INACT register.

**Register 0x27—ACT\_INACT\_CTL (Read/Write)**

D7	D6	D5	D4
ACT ac/dc	ACT_X enable	ACT_Y enable	ACT_Z enable
D3	D2	D1	D0
INACT ac/dc	INACT_X enable	INACT_Y enable	INACT_Z enable

**ACT AC/DC and INACT AC/DC Bits**

A setting of 0 selects dc-coupled operation, and a setting of 1 enables ac-coupled operation. In dc-coupled operation, the current acceleration magnitude is compared directly with THRESH\_ACT and THRESH\_INACT to determine whether activity or inactivity is detected.

In ac-coupled operation for activity detection, the acceleration value at the start of activity detection is taken as a reference value. New samples of acceleration are then compared to this reference value, and if the magnitude of the difference exceeds the THRESH\_ACT value, the device triggers an activity interrupt.

Similarly, in ac-coupled operation for inactivity detection, a reference value is used for comparison and is updated whenever the device exceeds the inactivity threshold. After the reference value is selected, the device compares the magnitude of the difference between the reference value and the current acceleration with THRESH\_INACT. If the difference is less than the value in THRESH\_INACT for the time in TIME\_INACT, the device is considered inactive and the inactivity interrupt is triggered.

**ACT\_x Enable Bits and INACT\_x Enable Bits**

A setting of 1 enables x-, y-, or z-axis participation in detecting activity or inactivity. A setting of 0 excludes the selected axis from participation. If all axes are excluded, the function is disabled.

**Register 0x28—THRESH\_FF (Read/Write)**

The THRESH\_FF register is eight bits and holds the threshold value, in unsigned format, for free-fall detection. The root-sum-square (RSS) value of all axes is calculated and compared with the value in THRESH\_FF to determine if a free-fall event occurred. The scale factor is 31.2 mg/LSB. Note that a value of 0 mg may

result in undesirable behavior if the free-fall interrupt is enabled. Values between 300 mg and 600 mg (0x0A to 0x13) are recommended.

#### Register 0x29—TIME\_FF (Read/Write)

The TIME\_FF register is eight bits and stores an unsigned time value representing the minimum time that the RSS value of all axes must be less than THRESH\_FF to generate a free-fall interrupt. The scale factor is 5 ms/LSB. A value of 0 may result in undesirable behavior if the free-fall interrupt is enabled. Values between 100 ms and 350 ms (0x14 to 0x46) are recommended.

#### Register 0x2A—TAP\_AXES (Read/Write)

D7	D6	D5	D4	D3	D2	D1	D0
0	0	0	0	Suppress	TAP_X enable	TAP_Y enable	TAP_Z enable

#### Suppress Bit

Setting the suppress bit suppresses double tap detection if acceleration greater than the value in THRESH\_TAP is present between taps. See the Tap Detection section for more details.

#### TAP\_x Enable Bits

A setting of 1 in the TAP\_X enable, TAP\_Y enable, or TAP\_Z enable bit enables x-, y-, or z-axis participation in tap detection. A setting of 0 excludes the selected axis from participation in tap detection.

#### Register 0x2B—ACT\_TAP\_STATUS (Read Only)

D7	D6	D5	D4	D3	D2	D1	D0
0	ACT_X source	ACT_Y source	ACT_Z source	Asleep	TAP_X source	TAP_Y source	TAP_Z source

#### ACT\_x Source and TAP\_x Source Bits

These bits indicate the first axis involved in a tap or activity event. A setting of 1 corresponds to involvement in the event, and a setting of 0 corresponds to no involvement. When new data is available, these bits are not cleared but are overwritten by the new data. The ACT\_TAP\_STATUS register should be read before clearing the interrupt. Disabling an axis from participation clears the corresponding source bit when the next activity or tap/double tap event occurs.

#### Asleep Bit

A setting of 1 in the asleep bit indicates that the part is asleep, and a setting of 0 indicates that the part is not asleep. See the Register 0x2D—POWER\_CTL (Read/Write) section for more information on autosleep mode.

#### Register 0x2C—BW\_RATE (Read/Write)

D7	D6	D5	D4	D3	D2	D1	D0
0	0	0	LOW_POWER	Rate			

#### LOW\_POWER Bit

A setting of 0 in the LOW\_POWER bit selects normal operation, and a setting of 1 selects reduced power operation, which has somewhat higher noise (see the Power Modes section for details).

#### Rate Bits

These bits select the device bandwidth and output data rate (see Table 7 and Table 8 for details). The default value is 0x0A, which translates to a 100 Hz output data rate. An output data rate should be selected that is appropriate for the communication protocol and frequency selected. Selecting too high of an output data rate with a low communication speed results in samples being discarded.

#### Register 0x2D—POWER\_CTL (Read/Write)

D7	D6	D5	D4	D3	D2	D1	D0
0	0	Link	AUTO_SLEEP	Measure	Sleep	Wakeup	

#### Link Bit

A setting of 1 in the link bit with both the activity and inactivity functions enabled delays the start of the activity function until inactivity is detected. After activity is detected, inactivity detection begins, preventing the detection of activity. This bit serially links the activity and inactivity functions. When this bit is set to 0, the inactivity and activity functions are concurrent. Additional information can be found in the Link Mode section.

When clearing the link bit, it is recommended that the part be placed into standby mode and then set back to measurement mode with a subsequent write. This is done to ensure that the device is properly biased if sleep mode is manually disabled; otherwise, the first few samples of data after the link bit is cleared may have additional noise, especially if the device was asleep when the bit was cleared.

#### AUTO\_SLEEP Bit

If the link bit is set, a setting of 1 in the AUTO\_SLEEP bit sets the ADXL350 to switch to sleep mode when inactivity is detected (that is, when acceleration has been below the THRESH\_INACT value for at least the time indicated by TIME\_INACT). A setting of 0 disables automatic switching to sleep mode. See the description of the sleep bit in this section for more information.

When clearing the AUTO\_SLEEP bit, it is recommended that the part be placed into standby mode and then set back to measurement mode with a subsequent write. This is done to ensure that the device is properly biased if sleep mode is manually disabled; otherwise, the first few samples of data after the AUTO\_SLEEP bit is cleared may have additional noise, especially if the device was asleep when the bit was cleared.

#### Measure Bit

A setting of 0 in the measure bit places the part into standby mode, and a setting of 1 places the part into measurement mode. The ADXL350 powers up in standby mode with minimum power consumption.

#### Sleep Bit

A setting of 0 in the sleep bit puts the part into the normal mode of operation, and a setting of 1 places the part into sleep mode. Sleep mode suppresses DATA\_READY, stops transmission of data

to FIFO, and switches the sampling rate to one specified by the wakeup bits. In sleep mode, only the activity function can be used.

When clearing the sleep bit, it is recommended that the part be placed into standby mode and then set back to measurement mode with a subsequent write. This is done to ensure that the device is properly biased if sleep mode is manually disabled; otherwise, the first few samples of data after the sleep bit is cleared may have additional noise, especially if the device was asleep when the bit was cleared.

**Wakeup Bits**

These bits control the frequency of readings in sleep mode as described in Table 18.

**Table 18. Frequency of Readings in Sleep Mode**

Setting		Frequency (Hz)
D1	D0	
0	0	8
0	1	4
1	0	2
1	1	1

**Register 0x2E—INT\_ENABLE (Read/Write)**

<b>D7</b> DATA_READY	<b>D6</b> SINGLE_TAP	<b>D5</b> DOUBLE_TAP	<b>D4</b> Activity
<b>D3</b> Inactivity	<b>D2</b> FREE_FALL	<b>D1</b> Watermark	<b>D0</b> Overrun

Setting bits in this register to a value of 1 enables their respective functions to generate interrupts, whereas a value of 0 prevents the functions from generating interrupts. The DATA\_READY, watermark, and overrun bits enable only the interrupt output; the functions are always enabled. It is recommended that interrupts be configured before enabling their outputs.

**Register 0x2F—INT\_MAP (Read/Write)**

<b>D7</b> DATA_READY	<b>D6</b> SINGLE_TAP	<b>D5</b> DOUBLE_TAP	<b>D4</b> Activity
<b>D3</b> Inactivity	<b>D2</b> FREE_FALL	<b>D1</b> Watermark	<b>D0</b> Overrun

Any bits set to 0 in this register send their respective interrupts to the INT1 pin, whereas bits set to 1 send their respective interrupts to the INT2 pin. All selected interrupts for a given pin are ORed.

**Register 0x30—INT\_SOURCE (Read Only)**

<b>D7</b> DATA_READY	<b>D6</b> SINGLE_TAP	<b>D5</b> DOUBLE_TAP	<b>D4</b> Activity
<b>D3</b> Inactivity	<b>D2</b> FREE_FALL	<b>D1</b> Watermark	<b>D0</b> Overrun

Bits set to 1 in this register indicate that their respective functions have triggered an event, whereas a value of 0 indicates that the corresponding event has not occurred. The DATA\_READY, watermark, and overrun bits are always set if the corresponding events occur, regardless of the INT\_ENABLE register settings, and are cleared by reading data from the DATA\_X, DATA\_Y, and DATA\_Z registers. The DATA\_READY and watermark bits may require multiple reads, as indicated in the FIFO mode descriptions in the FIFO section. Other bits, and the corresponding interrupts, are cleared by reading the INT\_SOURCE register.

**Register 0x31—DATA\_FORMAT (Read/Write)**

<b>D7</b>	<b>D6</b>	<b>D5</b>	<b>D4</b>	<b>D3</b>	<b>D2</b>	<b>D1</b>	<b>D0</b>
SELF_TEST	SPI	INT_INVERT	0	FULL_RES	Justify	Range	

The DATA\_FORMAT register controls the presentation of data to Register 0x32 through Register 0x37. All data, except that for the ±8 g range, is clipped internally to avoid rollover.

**SELF\_TEST Bit**

A setting of 1 in the SELF\_TEST bit applies a self-test force to the sensor, causing a shift in the output data. A value of 0 disables the self-test force.

**SPI Bit**

A value of 1 in the SPI bit sets the device to 3-wire SPI mode, and a value of 0 sets the device to 4-wire SPI mode.

**INT\_INVERT Bit**

A value of 0 in the INT\_INVERT bit sets the interrupts to active high, and a value of 1 sets the interrupts to active low.

**FULL\_RES Bit**

When this bit is set to a value of 1, the device is in full resolution mode, where the output resolution increases with the g range set by the range bits to maintain a 2 mg/LSB scale factor. When the FULL\_RES bit is set to 0, the device is in 10-bit mode, and the range bits determine the maximum g range and scale factor.

**Justify Bit**

A setting of 1 in the Justify bit selects left (MSB) justified mode, and a setting of 0 selects right justified mode with sign extension.

**Range Bits**

These bits set the g range as described in Table 19.

**Table 19. g Range Setting**

Setting		g Range
D1	D0	
0	0	±1 g
0	1	±2 g
1	0	±4 g
1	1	±8 g

**Register 0x32 to Register 0x37—DATAx0, DATAx1, DATAy0, DATAy1, DATAz0, DATAz1 (Read Only)**

These six bytes (Register 0x32 to Register 0x37) are eight bits each and hold the output data for each axis. Register 0x32 and Register 0x33 hold the output data for the x-axis, Register 0x34 and Register 0x35 hold the output data for the y-axis, and Register 0x36 and Register 0x37 hold the output data for the z-axis. The output data is two's complement, with DATAx0 as the least significant byte and DATAx1 as the most significant byte, where x represent X, Y, or Z. The DATA\_FORMAT register (Address 0x31) controls the format of the data. It is recommended that a multiple-byte read of all registers be performed to prevent a change in data between reads of sequential registers.

**Register 0x38—FIFO\_CTL (Read/Write)**

D7	D6	D5	D4	D3	D2	D1	D0
FIFO_MODE		Trigger	Samples				

**FIFO\_MODE Bits**

These bits set the FIFO mode, as described in Table 20.

**Table 20. FIFO Modes**

Setting		Mode	Function
D7	D6		
0	0	Bypass	FIFO is bypassed.
0	1	FIFO	FIFO collects up to 32 values and then stops collecting data, collecting new data only when FIFO is not full.
1	0	Stream	FIFO holds the last 32 data values. When FIFO is full, the oldest data is overwritten with newer data.
1	1	Trigger	When triggered by the trigger bit, FIFO holds the last data samples before the trigger event and then continues to collect data until full. New data is collected only when FIFO is not full.

**Trigger Bit**

A value of 0 in the trigger bit links the trigger event of trigger mode to INT1, and a value of 1 links the trigger event to INT2.

**Samples Bits**

The function of these bits depends on the FIFO mode selected (see Table 21). Entering a value of 0 in the samples bits immediately sets the watermark status bit in the INT\_SOURCE register, regardless of which FIFO mode is selected. Undesirable operation may occur if a value of 0 is used for the samples bits when trigger mode is used.

**Table 21. Samples Bits Functions**

FIFO Mode	Samples Bits Function
Bypass	None.
FIFO	Specifies how many FIFO entries are needed to trigger a watermark interrupt.
Stream	Specifies how many FIFO entries are needed to trigger a watermark interrupt.
Trigger	Specifies how many FIFO samples are retained in the FIFO buffer before a trigger event.

**0x39—FIFO\_STATUS (Read Only)**

D7	D6	D5	D4	D3	D2	D1	D0
FIFO_TRIG		0	Entries				

**FIFO\_TRIG Bit**

A 1 in the FIFO\_TRIG bit corresponds to a trigger event occurring, and a 0 means that a FIFO trigger event has not occurred.

**Entries Bits**

These bits report how many data values are stored in FIFO. Access to collect the data from FIFO is provided through the DATAx, DATAy, and DATAz registers. FIFO reads must be done in burst or multiple-byte mode because each FIFO level is cleared after any read (single- or multiple-byte) of FIFO. FIFO stores a maximum of 32 entries, which equates to a maximum of 33 entries available at any given time because an additional entry is available at the output filter of the device.

## APPLICATIONS INFORMATION

### POWER SUPPLY DECOUPLING

A 1  $\mu\text{F}$  tantalum capacitor ( $C_S$ ) at  $V_S$  and a 0.1  $\mu\text{F}$  ceramic capacitor ( $C_{IO}$ ) at  $V_{DD\ I/O}$  placed close to the ADXL350 supply pins is used for testing and is recommended to adequately decouple the accelerometer from noise on the power supply. If additional decoupling is necessary, a resistor or ferrite bead, no larger than 100  $\Omega$ , in series with  $V_S$  may be helpful. Additionally, increasing the bypass capacitance on  $V_S$  to a 10  $\mu\text{F}$  tantalum capacitor in parallel with a 0.1  $\mu\text{F}$  ceramic capacitor may also improve noise.

Care should be taken to ensure that the connection from the ADXL350 ground to the power supply ground has low impedance because noise transmitted through ground has an effect similar to noise transmitted through  $V_S$ . It is recommended that  $V_S$  and  $V_{DD\ I/O}$  be separate supplies to minimize digital clocking noise on the  $V_S$  supply. If this is not possible, additional filtering of the supplies as previously mentioned may be necessary.

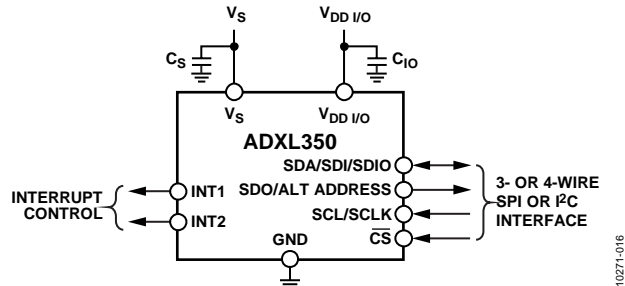

Figure 58. Application Diagram

### MECHANICAL CONSIDERATIONS FOR MOUNTING

The ADXL350 should be mounted on the PCB in a location close to a hard mounting point of the PCB to the case. Mounting the ADXL350 at an unsupported PCB location, as shown in Figure 59, may result in large, apparent measurement errors due to undamped PCB vibration. Locating the accelerometer near a hard mounting point ensures that any PCB vibration at the accelerometer is above the accelerometer’s mechanical sensor resonant frequency and, therefore, effectively invisible to the accelerometer.

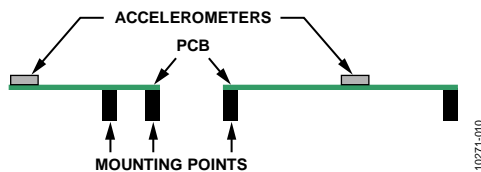

Figure 59. Incorrectly Placed Accelerometers

### TAP DETECTION

The tap interrupt function is capable of detecting either single or double taps. The following parameters are shown in Figure 60 for a valid single and valid double tap event:

- The tap detection threshold is defined by the THRESH\_TAP register (Address 0x1D).

- The maximum tap duration time is defined by the DUR register (Address 0x21).
- The tap latency time is defined by the latent register (Address 0x22) and is the waiting period from the end of the first tap until the start of the time window, when a second tap can be detected, which is determined by the value in the window register (Address 0x23).
- The interval after the latency time (set by the latent register) is defined by the window register. Although a second tap must begin after the latency time has expired, it need not finish before the end of the time defined by the window register.

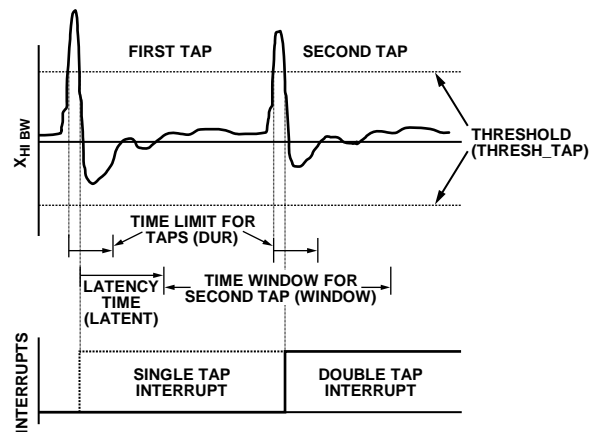

Figure 60. Tap Interrupt Function with Valid Single and Double Taps

If only the single tap function is in use, the single tap interrupt is triggered when the acceleration goes below the threshold, as long as DUR has not been exceeded. If both single and double tap functions are in use, the single tap interrupt is triggered when the double tap event has been either validated or invalidated.

Several events can occur to invalidate the second tap of a double tap event. First, if the suppress bit in the TAP\_AXES register (Address 0x2A) is set, any acceleration spike above the threshold during the latency time (set by the latent register) invalidates the double tap detection, as shown in Figure 61.

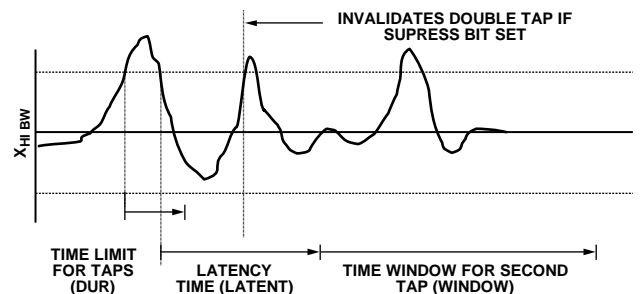

Figure 61. Double Tap Event Invalid Due to High g Event When the Suppress Bit Is Set

A double tap event can also be invalidated if acceleration above the threshold is detected at the start of the time window for the second tap (set by the window register). This results in an invalid double tap at the start of this window, as shown in Figure 62.

Additionally, a double tap event can be invalidated if an acceleration exceeds the time limit for taps (set by the DUR register), resulting in an invalid double tap at the end of the DUR time limit for the second tap event, also shown in Figure 62.

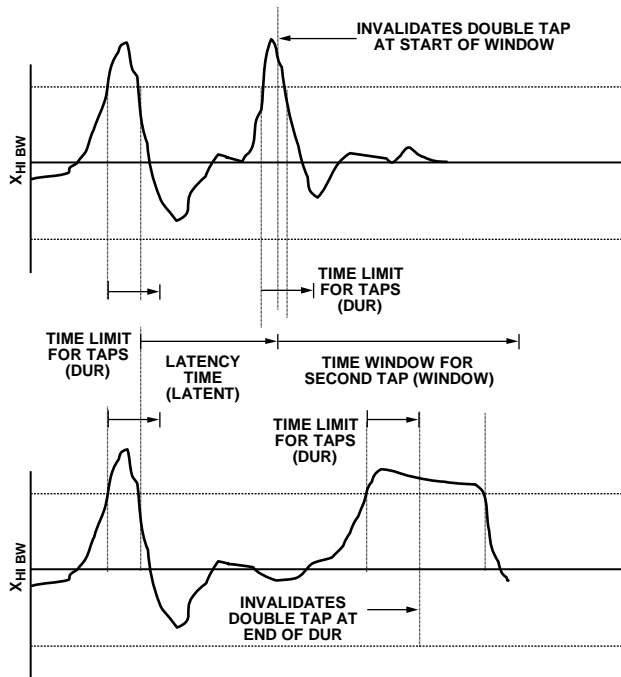

Figure 62. Tap Interrupt Function with Invalid Double Taps

Single taps, double taps, or both can be detected by setting the respective bits in the INT\_ENABLE register (Address 0x2E). Control over participation of each of the three axes in single tap/double tap detection is exerted by setting the appropriate bits in the TAP\_AXES register (Address 0x2A). For the double tap function to operate, both the latent and window registers must be set to a nonzero value.

Every mechanical system has somewhat different single tap/double tap responses based on the mechanical characteristics of the system. Therefore, some experimentation with values for the latent, window, and THRESH\_TAP registers is required. In general, a good starting point is to set the latent register to a value greater than 0x10, to set the window register to a value greater than 0x10, and to set the THRESH\_TAP register to be greater than 3 g. Setting a very low value in the latent, window, or THRESH\_TAP register may result in an unpredictable response due to the accelerometer picking up echoes of the tap inputs.

After a tap interrupt has been received, the first axis to exceed the THRESH\_TAP level is reported in the ACT\_TAP\_STATUS register (Address 0x2B). This register is never cleared, but is overwritten with new data.

## THRESHOLD

The lower output data rates are achieved by decimating a common sampling frequency inside the device. The activity, free-fall, and single tap/double tap detection functions are performed using unfiltered data. Since the output data is filtered, the high frequency and high g data that is used to determine activity, free-fall, and single tap/double tap events may not be present if the output of the accelerometer is examined. This may result in trigger events being detected when acceleration does not appear to trigger an event because the unfiltered data may have exceeded a threshold or remained below a threshold for a certain period of time while the filtered output data has not exceeded such a threshold.

## LINK MODE

The function of the link bit is to reduce the number of activity interrupts that the processor must service by setting the device to look for activity only after inactivity. For proper operation of this feature, the processor must still respond to the activity and inactivity interrupts by reading the INT\_SOURCE register (Address 0x30) and, therefore, clearing the interrupts. If an activity interrupt is not cleared, the part cannot go into autosleep mode. The asleep bit in the ACT\_TAP\_STATUS register (Address 0x2B) indicates if the part is asleep.

## SLEEP MODE VS. LOW POWER MODE

In applications where a low data rate is sufficient and low power consumption is desired, it is recommended that the low power mode be used in conjunction with the FIFO. The sleep mode, while offering a low data rate and low average current consumption, suppresses the DATA\_READY interrupt, preventing the accelerometer from sending an interrupt signal to the host processor when data is ready to be collected. In this application, setting the part into low power mode (by setting the LOW\_POWER bit in the BW\_RATE register) and enabling the FIFO in FIFO mode to collect a large value of samples reduces the power consumption of the ADXL350 and allows the host processor to go to sleep while the FIFO is filling up.

## OFFSET CALIBRATION

Accelerometers are mechanical structures containing elements that are free to move. These moving parts can be very sensitive to mechanical stresses, much more so than solid-state electronics. The 0 g bias or offset is an important accelerometer metric because it defines the baseline for measuring acceleration. Additional stresses can be applied during assembly of a system containing an accelerometer. These stresses can come from, but are not limited to, component soldering, board stress during mounting, and application of any compounds on or over the component. If calibration is deemed necessary, it is recommended that calibration be performed after system assembly to compensate for these effects.

A simple method of calibration is to measure the offset while assuming that the sensitivity of the ADXL350 is as specified in Table 1. The offset can then be automatically accounted for by

using the built-in offset registers. This results in the data acquired from the DATA registers already compensating for any offset.

In a no-turn or single-point calibration scheme, the part is oriented such that one axis, typically the z-axis, is in the 1 g field of gravity and the remaining axes, typically the x-axis and y-axis, are in a 0 g field. The output is then measured by taking the average of a series of samples. The number of samples averaged is a choice of the system designer, but a recommended starting point is 0.1 sec worth of data for data rates of 100 Hz or greater. This corresponds to 10 samples at the 100 Hz data rate. For data rates less than 100 Hz, it is recommended that at least 10 samples be averaged together. These values are stored as  $X_{0g}$ ,  $Y_{0g}$ , and  $Z_{+1g}$  for the 0 g measurements on the x-axis and y-axis and the 1 g measurement on the z-axis, respectively.

The values measured for  $X_{0g}$  and  $Y_{0g}$  correspond to the x- and y-axis offset, and compensation is done by subtracting those values from the output of the accelerometer to obtain the actual acceleration.

$$X_{ACTUAL} = X_{MEAS} - X_{0g}$$

$$Y_{ACTUAL} = Y_{MEAS} - Y_{0g}$$

Because the z-axis measurement was done in a +1 g field, a no-turn or single-point calibration scheme assumes an ideal sensitivity,  $S_z$  for the z-axis. This is subtracted from  $Z_{+1g}$  to attain the z-axis offset, which is then subtracted from future measured values to obtain the actual value:

$$Z_{0g} = Z_{+1g} - S_z$$

$$Z_{ACTUAL} = Z_{MEAS} - Z_{0g}$$

The ADXL350 can automatically compensate the output for offset by using the offset registers (Register 0x1E, Register 0x1F, and Register 0x20). These registers contain an 8-bit, twos complement value that is automatically added to all measured acceleration values, and the result is then placed into the DATA registers. Because the value placed in an offset register is additive, a negative value is placed into the register to eliminate a positive offset and vice versa for a negative offset. The register has a scale factor of 7.8 mg/LSB and is independent of the selected g-range.

As an example, assume that the ADXL350 is placed into full-resolution mode with a sensitivity of typically 512 LSB/g. The part is oriented such that the z-axis is in the field of gravity and x-, y-, and z-axis outputs are measured as +10 LSB, -13 LSB, and +9 LSB, respectively. Using the previous equations,  $X_{0g}$  is +10 LSB,  $Y_{0g}$  is -13 LSB, and  $Z_{0g}$  is +9 LSB. Each LSB of output in full-resolution is 1.95 mg or one-quarter of an LSB of the offset register. Because the offset register is additive, the 0 g values are negated and rounded to the nearest LSB of the offset register:

$$X_{OFFSET} = -\text{Round}(10/4) = -3 \text{ LSB}$$

$$Y_{OFFSET} = -\text{Round}(-13/4) = 3 \text{ LSB}$$

$$Z_{OFFSET} = -\text{Round}(9/4) = -2 \text{ LSB}$$

These values are programmed into the OFSX, OFSY, and OFXZ registers, respectively, as 0xFD, 0x03, and 0xFE. As with all

registers in the ADXL350, the offset registers do not retain the value written into them when power is removed from the part. Power cycling the ADXL350 returns the offset registers to their default value of 0x00.

Because the no-turn or single-point calibration method assumes an ideal sensitivity in the z-axis, any error in the sensitivity results in offset error. To help minimize this error, an additional measurement point can be used with the z-axis in a 0 g field and the 0 g measurement can be used in the  $Z_{ACTUAL}$  equation.

## USING SELF-TEST

The self-test change is defined as the difference between the acceleration output of an axis with self-test enabled and the acceleration output of the same axis with self-test disabled (see Endnote 4 of Table 1). This definition assumes that the sensor does not move between these two measurements, because if the sensor moves, a non-self-test related shift corrupts the test.

Proper configuration of the ADXL350 is also necessary for an accurate self-test measurement. The part should be set with a data rate that is greater than or equal to 100 Hz. This is done by ensuring that a value greater than or equal to 0x0A is written into the rate bits (Bit D3 through Bit D0) in the BW\_RATE register (Address 0x2C).

It is also recommended that the part be set to  $\pm 8$  g mode to ensure that there is sufficient dynamic range for the entire self-test shift. This is done by setting Bit D3 of the DATA\_FORMAT register (Address 0x31) and writing a value of 0x03 to the range bits (Bit D1 and Bit D0) of the DATA\_FORMAT register (Address 0x31). This results in a high dynamic range for measurement and a 2 mg/LSB scale factor.

After the part is configured for accurate self-test measurement, several samples of x-, y-, and z-axis acceleration data should be retrieved from the sensor and averaged together. The number of samples averaged is a choice of the system designer, but a recommended starting point is 0.1 sec worth of data, which corresponds to 10 samples at 100 Hz data rate. The averaged values should be stored and labeled appropriately as the self-test disabled data, that is,  $X_{ST\_OFF}$ ,  $Y_{ST\_OFF}$ , and  $Z_{ST\_OFF}$ .

Next, self-test should be enabled by setting Bit D7 of the DATA\_FORMAT register (Address 0x31). The output needs some time (about four samples) to settle after enabling self-test. After allowing the output to settle, several samples of the x-, y-, and z-axis acceleration data should be taken again and averaged. It is recommended that the same number of samples be taken for this average as was previously taken. These averaged values should again be stored and labeled appropriately as the value with self-test enabled, that is,  $X_{ST\_ON}$ ,  $Y_{ST\_ON}$ , and  $Z_{ST\_ON}$ . Self-test can then be disabled by clearing Bit D7 of the DATA\_FORMAT register (Address 0x31).

With the stored values for self-test enabled and disabled, the self-test change is as follows:

$$X_{ST} = X_{ST\_ON} - X_{ST\_OFF}$$

$$Y_{ST} = Y_{ST\_ON} - Y_{ST\_OFF}$$

$$Z_{ST} = Z_{ST\_ON} - Z_{ST\_OFF}$$

Because the measured output for each axis is expressed in LSBs,  $X_{ST}$ ,  $Y_{ST}$ , and  $Z_{ST}$  are also expressed in LSBs. These values can be converted to  $g$ 's of acceleration by multiplying each value by the 2 mg/LSB scale factor, if configured for full-resolution, 8  $g$  mode. Additionally, Table 13 through Table 16 correspond to the self-test range converted to LSBs and can be compared with the measured self-test change. If the part was placed into full-resolution, 8  $g$  mode, the values listed in Table 13 should be used.

Although the fixed 10-bit mode or a range other than 8  $g$  can be used, a different set of values, as indicated in Table 14 through Table 16, would need to be used. Using a range below 8  $g$  may result in insufficient dynamic range and should be considered when selecting the range of operation for measuring self-test. In addition, note that the range in Table 1 and the values in Table 13 through Table 16 take into account all possible supply voltages,  $V_S$ , and no additional conversion due to  $V_S$  is necessary.

If the self-test change is within the valid range, the test is considered successful. Generally, a part is considered to pass if the minimum magnitude of change is achieved. However, a part that changes by more than the maximum magnitude is not necessarily a failure.



AXES OF ACCELERATION SENSITIVITY

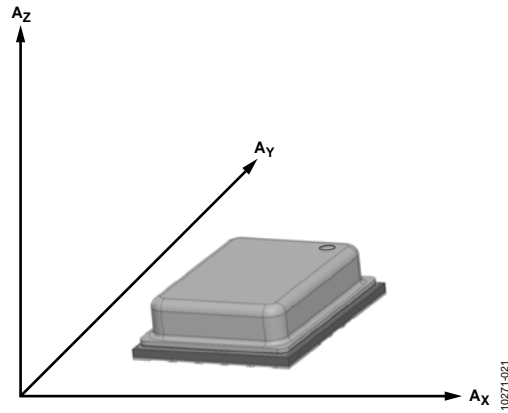

Figure 63. Axes of Acceleration Sensitivity (Corresponding Output Voltage Increases When Accelerated Along the Sensitive Axis)

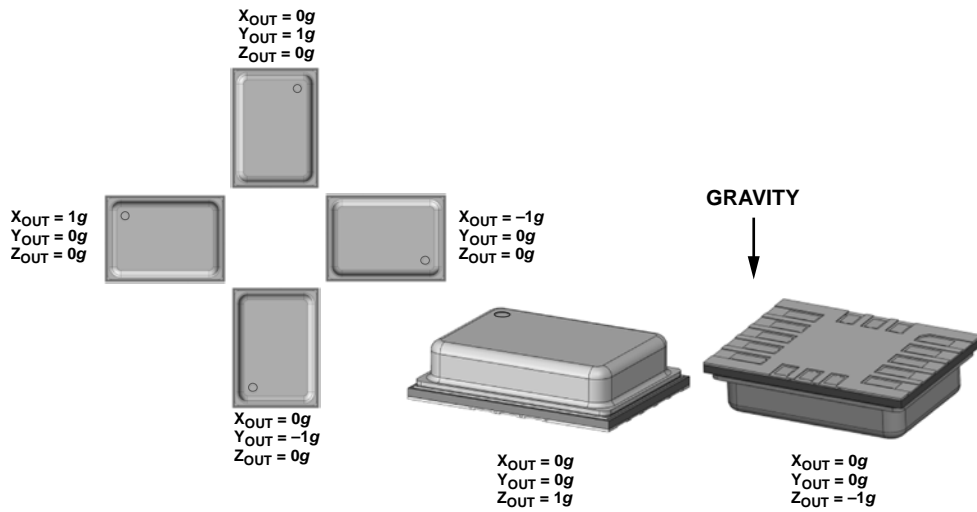

Figure 64. Output Response vs. Orientation to Gravity

10271-022

**LAYOUT AND DESIGN RECOMMENDATIONS**

Figure 65 shows the recommended printed wiring board land pattern. Figure 66 and Table 22 provide details about the recommended soldering profile.

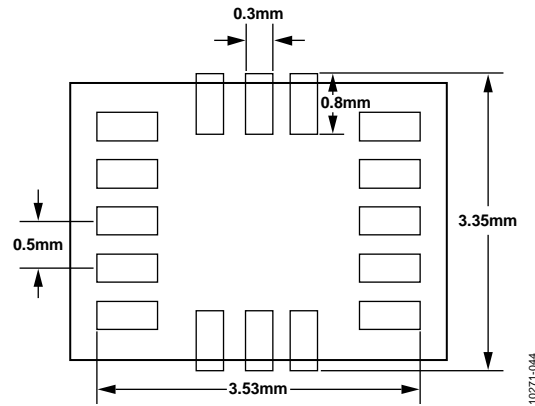

Figure 65. Recommended Printed Wiring Board Land Pattern (Dimensions shown in millimeters)

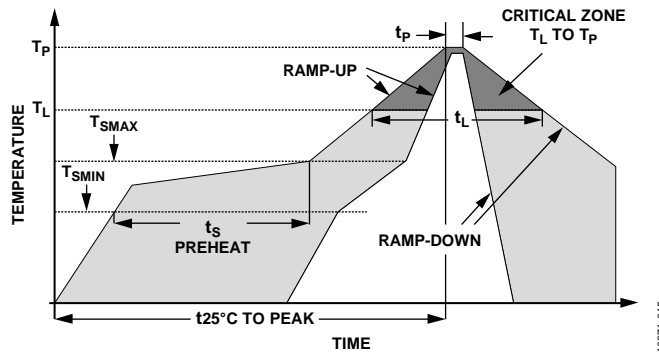

Figure 66. Recommended Soldering Profile

**Table 22. Recommended Soldering Profile<sup>1, 2</sup>**

Profile Feature	Condition	
	Sn63/Pb37	Pb-Free
Average Ramp Rate from Liquid Temperature ( $T_L$ ) to Peak Temperature ( $T_P$ )	3°C/sec max	3°C/sec max
Preheat		
Minimum Temperature ( $T_{SMIN}$ )	100°C	150°C
Maximum Temperature ( $T_{SMAX}$ )	150°C	200°C
Time from $T_{SMIN}$ to $T_{SMAX}$ ( $t_s$ )	60 sec to 120 sec	60 sec to 180 sec
$T_{SMAX}$ to $T_L$ Ramp-Up Rate	3°C/sec max	3°C/sec max
Liquid Temperature ( $T_L$ )	183°C	217°C
Time Maintained Above $T_L$ ( $t_L$ )	60 sec to 150 sec	60 sec to 150 sec
Peak Temperature ( $T_P$ )	240 + 0/-5°C	260 + 0/-5°C
Time of Actual $T_P$ - 5°C ( $t_p$ )	10 sec to 30 sec	20 sec to 40 sec
Ramp-Down Rate	6°C/sec max	6°C/sec max
Time 25°C to Peak Temperature	6 minutes max	8 minutes max

<sup>1</sup> Based on JEDEC Standard J-STD-020D.1.

<sup>2</sup> For best results, the soldering profile should be in accordance with the recommendations of the manufacturer of the solder paste used.

OUTLINE DIMENSIONS

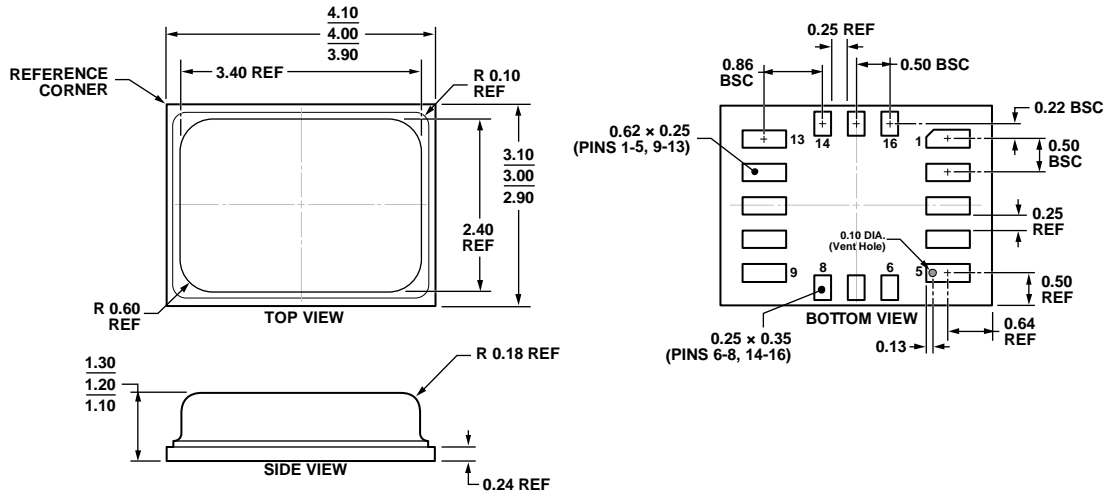

Figure 67. 16-Terminal Chip Array, Small Outline, No Lead Cavity [LGA\_CAV]  
 4.00 mm × 3.00 mm × 1.2 mm Body  
 (CE-16-3)  
 Dimensions shown in millimeters

07-13-2012B

ORDERING GUIDE

Model <sup>1</sup>	Measurement Range (g)	Specified Voltage (V)	Temperature Range	Package Description	Package Option
ADXL350BCEZ-RL	±1, ±2, ±4, ±8	2.5	−40°C to +85°C	16-Terminal [LGA_CAV]	CE-16-3
ADXL350BCEZ-RL7	±1, ±2, ±4, ±8	2.5	−40°C to +85°C	16-Terminal [LGA_CAV]	CE-16-3
EVAL-ADXL350Z				Evaluation Board	
EVAL-ADXL350Z-M				Analog Devices Inertial Sensor Evaluation System, Includes ADXL350 Satellite	
EVAL-ADXL350Z-S				ADXL350 Satellite, Standalone	

<sup>1</sup> Z = RoHS Compliant Part.

**NOTES**

**NOTES**