

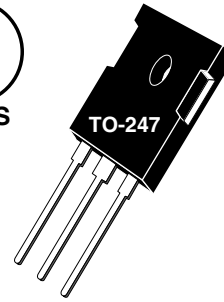

THE DATASHEET OF ARF448B

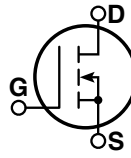

 Common
Source

RF POWER MOSFETs

N-CHANNEL ENHANCEMENT MODE

150V 140W 65MHz

The ARF448A and ARF448B comprise a symmetric pair of common source RF power transistors designed for push-pull scientific, commercial, medical and industrial RF power amplifier applications up to 65 MHz.

- **Specified 150 Volt, 40.68 MHz Characteristics:**
 - Output Power = 140 Watts.**
 - Gain = 15dB (Class C)**
 - Efficiency = 75%**
- **Low Cost Common Source RF Package.**
- **Very High Breakdown for Improved Ruggedness.**
- **Low Thermal Resistance.**
- **Nitride Passivated Die for Improved Reliability.**

MAXIMUM RATINGS

 All Ratings: $T_C = 25^\circ\text{C}$ unless otherwise specified.

Symbol	Parameter	ARF448A/448B	UNIT
V_{DSS}	Drain-Source Voltage	450	Volts
V_{DGO}	Drain-Gate Voltage	450	
I_D	Continuous Drain Current @ $T_C = 25^\circ\text{C}$	15	Amps
V_{GS}	Gate-Source Voltage	± 30	Volts
P_D	Total Power Dissipation @ $T_C = 25^\circ\text{C}$	230	Watts
$R_{\theta JC}$	Junction to Case	0.55	$^\circ\text{C/W}$
T_J, T_{STG}	Operating and Storage Junction Temperature Range	-55 to 150	$^\circ\text{C}$
T_L	Lead Temperature: 0.063" from Case for 10 Sec.	300	

STATIC ELECTRICAL CHARACTERISTICS

Symbol	Characteristic / Test Conditions	MIN	TYP	MAX	UNIT
BV_{DSS}	Drain-Source Breakdown Voltage ($V_{GS} = 0V, I_D = 250 \mu\text{A}$)	450			Volts
$V_{DS(ON)}$	On State Drain Voltage ^① ($I_D(ON) = 7.5A, V_{GS} = 10V$)			3	
I_{DSS}	Zero Gate Voltage Drain Current ($V_{DS} = V_{DSS}, V_{GS} = 0V$)			25	μA
	Zero Gate Voltage Drain Current ($V_{DS} = 0.8 V_{DSS}, V_{GS} = 0V, T_C = 125^\circ\text{C}$)			250	
I_{GSS}	Gate-Source Leakage Current ($V_{GS} = \pm 30V, V_{DS} = 0V$)			± 100	nA
g_{fs}	Forward Transconductance ($V_{DS} = 25V, I_D = 7.5A$)	5	8.5		mhos
$V_{GS(TH)}$	Gate Threshold Voltage ($V_{DS} = V_{GS}, I_D = 50mA$)	2		5	Volts

 **CAUTION:** These Devices are Sensitive to Electrostatic Discharge. Proper Handling Procedures Should Be Followed.

APT Website - <http://www.advancedpower.com>

DYNAMIC CHARACTERISTICS

ARF448A/448B

Symbol	Characteristic	Test Conditions	MIN	TYP	MAX	UNIT
C_{iss}	Input Capacitance	$V_{GS} = 0V$ $V_{DS} = 150V$ $f = 1\text{ MHz}$		1400	1700	pF
C_{oss}	Output Capacitance			150	200	
C_{rss}	Reverse Transfer Capacitance			65	100	
$t_{d(on)}$	Turn-on Delay Time	$V_{GS} = 15V$ $V_{DD} = 0.5 V_{DSS}$ $I_D = I_{D[Cont.]} @ 25^\circ C$ $R_G = 1.6\Omega$		7	15	ns
t_r	Rise Time			5	10	
$t_{d(off)}$	Turn-off Delay Time			23	40	
t_f	Fall Time			12	25	

FUNCTIONAL CHARACTERISTICS

Symbol	Characteristic	Test Conditions	MIN	TYP	MAX	UNIT
G_{PS}	Common Source Amplifier Power Gain	$f = 40.68\text{ MHz}$	13	15		dB
η	Drain Efficiency	$V_{GS} = 0V$ $V_{DD} = 150V$	70	75		%
ψ	Electrical Ruggedness VSWR 20:1	$P_{out} = 140W$	No Degradation in Output Power			

① Pulse Test: Pulse width < 380 nS, Duty Cycle < 2%

APT Reserves the right to change, without notice, the specifications and information contained herein.

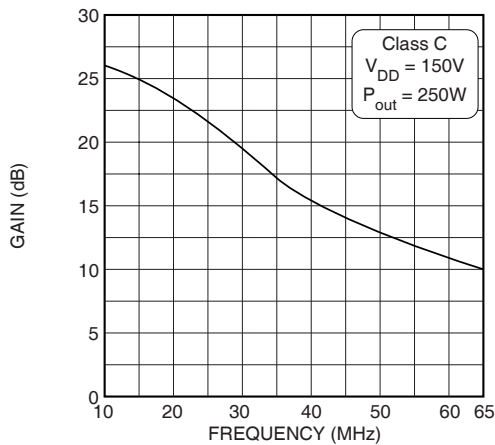

Figure 1, Typical Gain vs Frequency

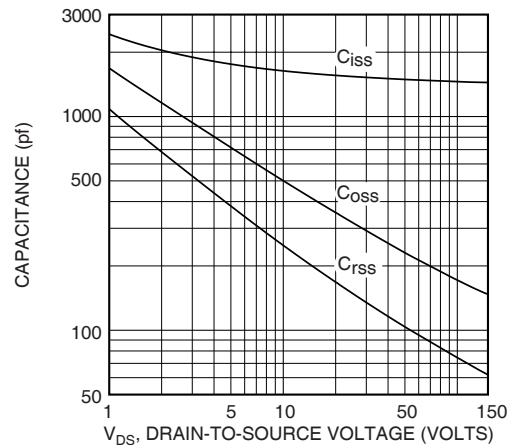

Figure 2, Typical Capacitance vs. Drain-to-Source Voltage

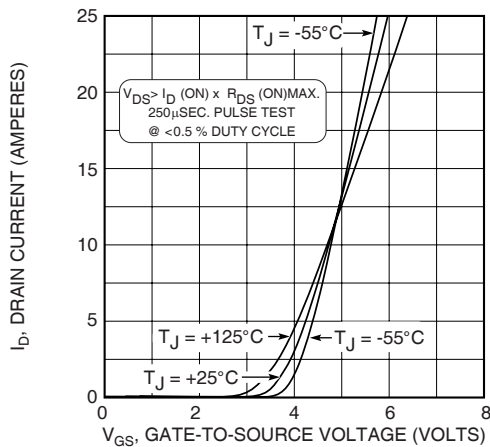

Figure 3, Typical Transfer Characteristics

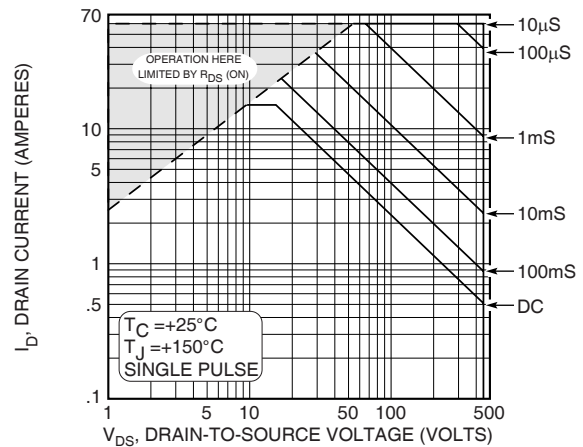

Figure 4, Typical Maximum Safe Operating Area

ARF448A/448B

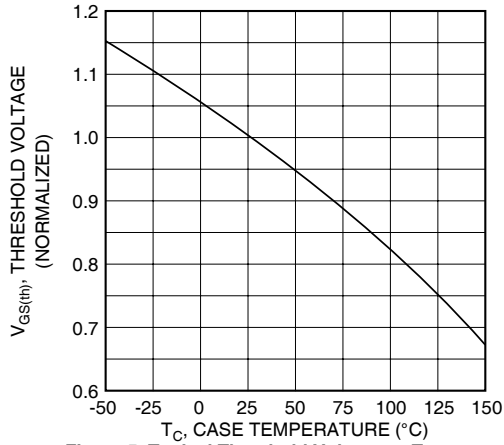

Figure 5, Typical Threshold Voltage vs Temperature

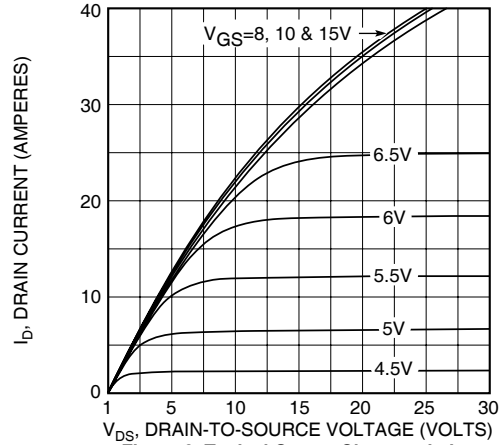

Figure 6, Typical Output Characteristics

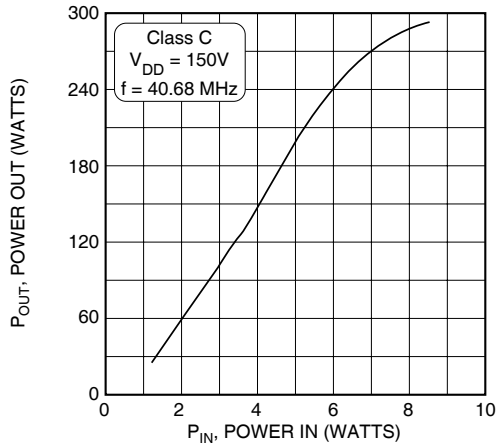

Figure 7, Typical Power Out vs Power In

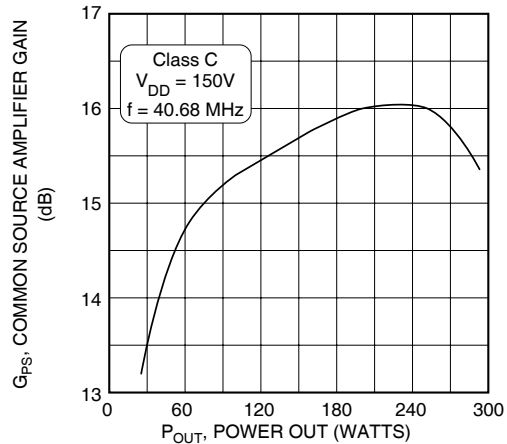

Figure 8, Typical Common Source Amplifier Gain vs Power Out

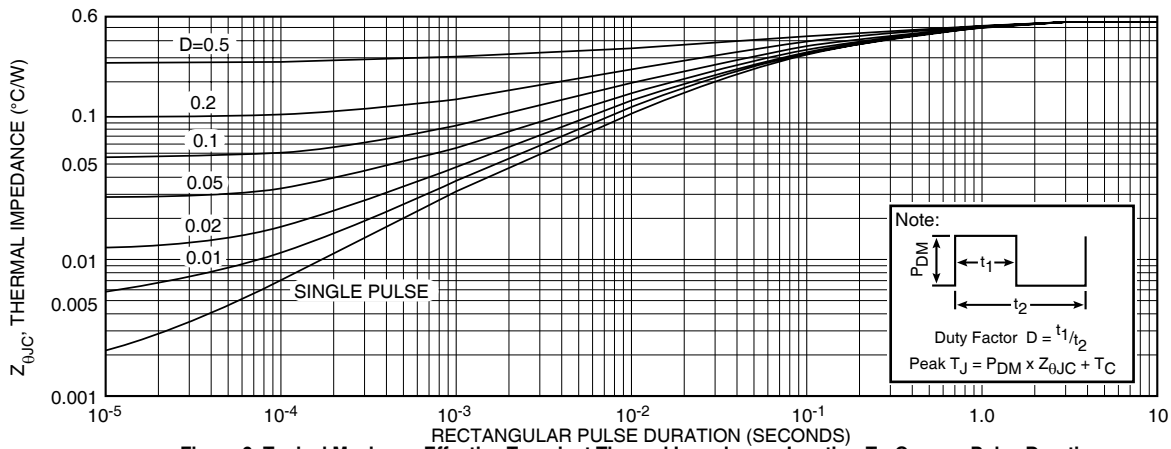

Figure 9, Typical Maximum Effective Transient Thermal Impedance, Junction-To-Case vs Pulse Duration

Table 1 - Typical Class C Large Signal Input-Output Impedance

Freq. (MHz)	Z _{in} (Ω)	Z _{oL} (Ω)
2.0	20.90 - j 9.2	56.00 - j 06.0
13.5	2.40 - j 6.8	37.00 - j 26.0
27.0	0.57 - j 2.6	18.00 - j 25.0
40.0	0.31 - j 0.5	9.90 - j 19.2
65.0	0.44 + j 1.9	4.35 - j 11.4

Z_{in} - gate shunted by 25Ω

Z_{oL} - conjugate of optimum load impedance for 250W at 150V

40.68 MHz Test Circuit

Parts List

- C1 -- 1800pF 100V chip
- C2-C4 -- Arco 463 Mica Trimmer
- C5-C7 -- 1nF 500V COG chip
- L1 -- 1" #16 AWG into hairpin ~9.6nH
- L2 -- 6t #16 AWG .25" ID ~165nH
- L3 -- 10t #18 AWG .25" ID ~0.47μH
- L4 -- VK200-4B ferrite choke ~3μH
- R1 -- 25 Ohm 1/2W Carbon
- T1 -- 9:1 Broadband Transformer

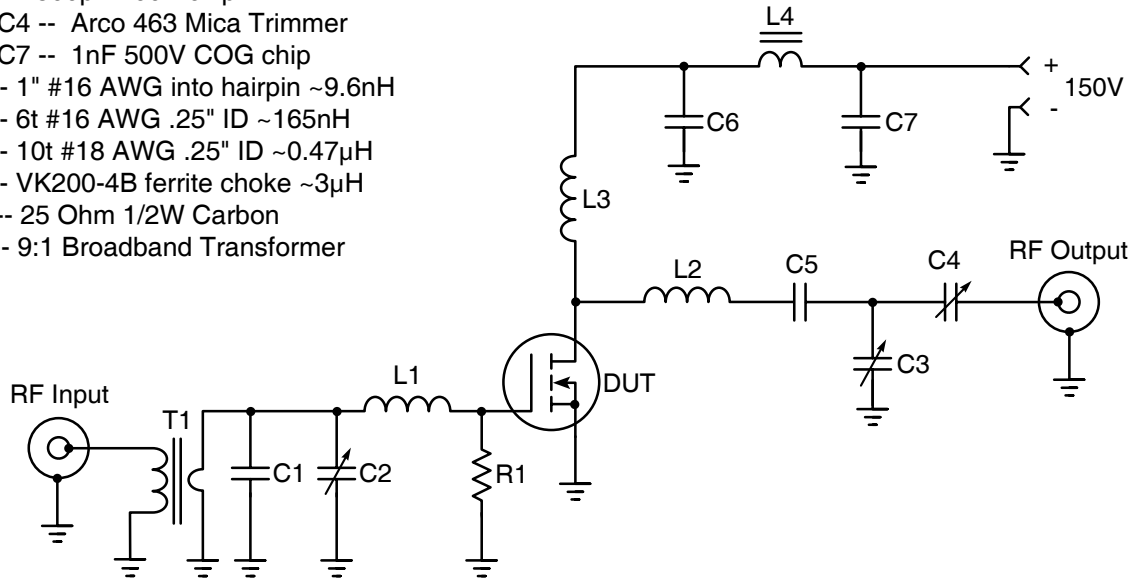

TO-247 Package Outline

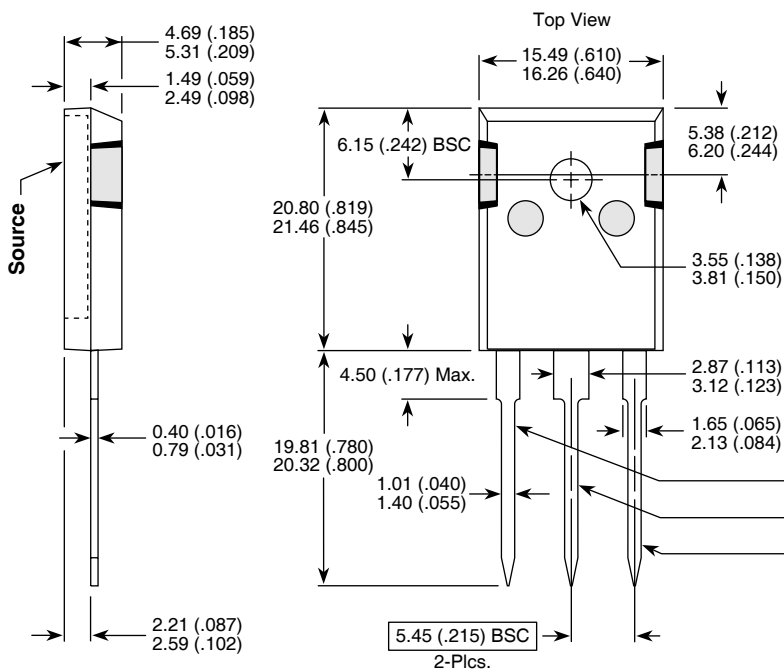

Dimensions in Millimeters and (Inches)
NOTE: The ARF446 and ARF447 comprise a symmetric pair of RF power transistors and meet the same electrical specifications. The device pin-outs are the mirror image of each other to allow ease of use as a push-pull pair.

Device	
ARF448A	ARF448B
Gate	Drain
Source	Source
Drain	Gate