



**THE DATASHEET OF
LM4804LQ/NOPB**



LM4804 Boomer™ Audio Power Amplifier SerieLow Voltage High Power Audio Power Amplifier

Check for Samples: [LM4804](#)

FEATURES

- **Pop & Click Circuitry Eliminates Noise During Turn-On and Turn-Off Transitions**
- **Low, 2µA (Max) Shutdown Current**
- **Low, 11mA (Typ) Quiescent Current ($V_{DD} = 4.2V$, $R_L = 8\Omega$)**
- **1.8W Mono BTL Output, $R_L = 8\Omega$, $V_{DD} = 3V$**
- **Short Circuit Protection**
- **Unity-Gain Stable**
- **External Gain Configuration Capability**

APPLICATIONS

- Cellphone
- PDA

KEY SPECIFICATIONS

- **Quiescent Power Supply Current ($V_{DD} = 4.2V$, $R_L = 8\Omega$), 11mA (Typ)**
- **BTL Output Power ($R_L = 8\Omega$, 2% THD+N, $V_{DD} = 3V$), 1.8W (Typ)**
- **Shutdown Current, 2µA (Max)**

Connection Diagram

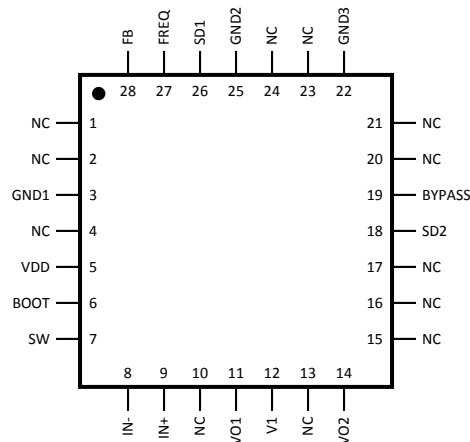

**Figure 1. LM4804LQ (5x5)
Top View
See Package Number NJB0028A**

DESCRIPTION

The LM4804 integrates a Boost Converter with an Audio Power Amplifier to drive voice coil speakers in portable applications. When powered by a 3V supply, it is capable of creating 1.8W power dissipation in an 8Ω bridge-tied-load (BTL) with less than 1% THD+N.

Boomer audio power amplifiers were designed specifically to provide high quality output power with a minimal amount of external components. The LM4804 does not require bootstrap capacitors, or snubber circuits. Therefore it is ideally suited for portable applications requiring high output voltage and minimal size.

The LM4804 features a micro-power shutdown mode. Additionally, the LM4804 features an internal thermal shutdown protection mechanism.

The LM4804 contains advanced pop & click circuitry that eliminates output transients which would otherwise occur during power or shutdown cycles.

The LM4804 is unity-gain stable. Its closed-loop gain is determined by the value of external, user selected resistors.



Please be aware that an important notice concerning availability, standard warranty, and use in critical applications of Texas Instruments semiconductor products and disclaimers thereto appears at the end of this data sheet.

Boomer is a trademark of Texas Instruments.

All other trademarks are the property of their respective owners.

Typical Application

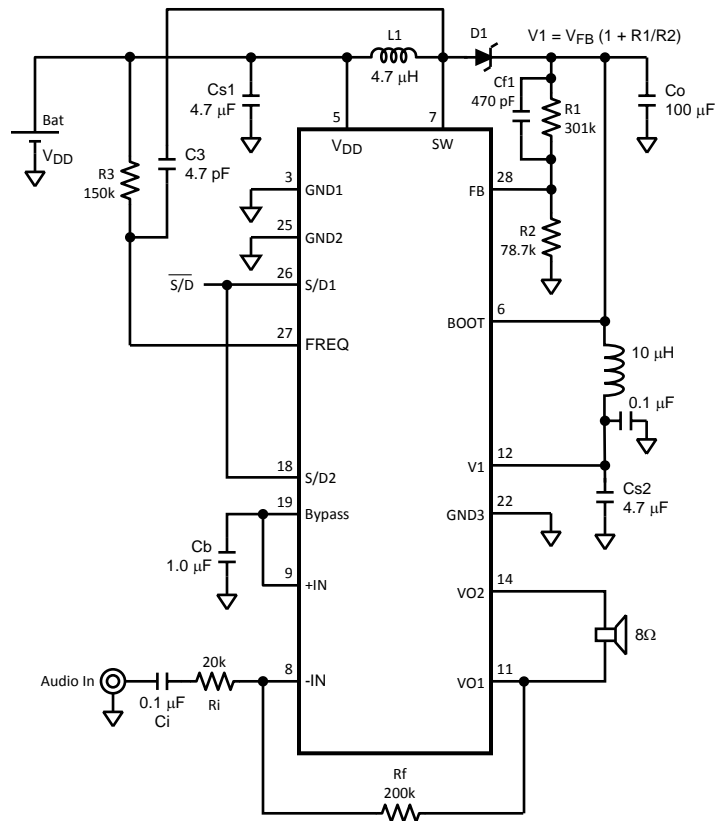

Figure 2. Typical LM4804 Audio Amplifier Application Circuit



These devices have limited built-in ESD protection. The leads should be shorted together or the device placed in conductive foam during storage or handling to prevent electrostatic damage to the MOS gates.

Absolute Maximum Ratings⁽¹⁾⁽²⁾⁽³⁾

Supply Voltage (V_{DD})		6.5V
Supply Voltage (V_1)		6.5V
Storage Temperature		-65°C to +150°C
Input Voltage		-0.3V to $V_{DD} + 0.3V$
Power Dissipation ⁽⁴⁾		Internally limited
ESD Susceptibility ⁽⁵⁾		2000V
ESD Susceptibility ⁽⁶⁾		200V
Junction Temperature		125°C
Thermal Resistance	θ_{JA} (WQFN)	59°C/W
See AN-1187 'Leadless Leadframe Packaging (WQFN)'.		

- (1) All voltages are measured with respect to the GND pin, unless otherwise specified.
- (2) *Absolute Maximum Ratings* indicate limits beyond which damage to the device may occur. *Operating Ratings* indicate conditions for which the device is functional, but do not ensure specific performance limits. *Electrical Characteristics* state DC and AC electrical specifications under particular test conditions which specify specific performance limits. This assumes that the device is within the Operating Ratings. Specifications are not ensured for parameters where no limit is given, however, the typical value is a good indication of device performance.
- (3) If Military/Aerospace specified devices are required, please contact the Texas Instruments Sales Office/Distributors for availability and specifications.
- (4) The maximum power dissipation must be derated at elevated temperatures and is dictated by T_{JMAX} , θ_{JA} , and the ambient temperature, T_A . The maximum allowable power dissipation is $P_{DMAX} = (T_{JMAX} - T_A) / \theta_{JA}$ or the given in Absolute Maximum Ratings, whichever is lower.
- (5) Human body model, 100pF discharged through a 1.5k Ω resistor.
- (6) Machine Model, 220pF – 240pF discharged through all pins.

Operating Ratings

Temperature Range	$T_{MIN} \leq T_A \leq T_{MAX}$	-40°C $\leq T_A \leq$ +85°C
	Supply Voltage (V_{DD})	$3V \leq V_{DD} \leq 5V$
	Supply Voltage (V_1)	$2.7V \leq V_1 \leq 6.1V$

Electrical Characteristics $V_{DD} = 4.2V$ ⁽¹⁾⁽²⁾

The following specifications apply for $V_{DD} = 4.2V$, $V_1 = 6.0V$, $A_{V-BTL} = 20dB$, $R_L = 8\Omega$, $f_{IN} = 1kHz$, $C_B = 1.0\mu F$, $R_1 = 301k\Omega$, $R_2 = 78.7k\Omega$ unless otherwise specified. Limits apply for $T_A = 25^\circ C$. See [Figure 2](#)

Symbol	Parameter	Conditions	LM4804		Units (Limits)
			Typical ⁽³⁾	Limit ⁽⁴⁾⁽⁵⁾	
I_{DD}	Quiescent Power Supply Current	$V_{IN} = 0$, $R_{LOAD} = \infty$	11	22	mA (max)
I_{SD}	Shutdown Current	$V_{SHUTDOWN} = GND$ ⁽⁶⁾⁽⁷⁾	0.1	2	μA (max)
V_{SDIH}	Shutdown Voltage Input High	SD1 SD2		$0.7V_{DD}$ 1.4	V (min)
V_{SDIL}	Shutdown Voltage Input Low	SD1 SD2		$0.15V_{DD}$ 0.4	V (max)
T_{WU}	Wake-up Time	$C_B = 1.0\mu F$	70		msec (max)
V_{OS}	Output Offset Voltage		4	40	mV (max)
TSD	Thermal Shutdown Temperature			125	°C (min)
P_{OUT}	Output Power	THD = 2% (max)	1.9	1.7	W (min)

- (1) All voltages are measured with respect to the GND pin, unless otherwise specified.
- (2) *Absolute Maximum Ratings* indicate limits beyond which damage to the device may occur. *Operating Ratings* indicate conditions for which the device is functional, but do not ensure specific performance limits. *Electrical Characteristics* state DC and AC electrical specifications under particular test conditions which specify specific performance limits. This assumes that the device is within the Operating Ratings. Specifications are not ensured for parameters where no limit is given, however, the typical value is a good indication of device performance.
- (3) Typicals are measured at 25°C and represent the parametric norm.
- (4) Limits are specified to Texas Instruments' AOQL (Average Outgoing Quality Level).
- (5) Datasheet min/max specification limits are ensured by design, test, or statistical analysis.
- (6) Shutdown current is measured in a normal room environment. The Shutdown pin should be driven as close as possible to V_{in} for minimum shutdown current.
- (7) Shutdown current is measured with components R1 and R2 removed.

Electrical Characteristics $V_{DD} = 4.2V^{(1)(2)}$ (continued)

The following specifications apply for $V_{DD} = 4.2V$, $V_1 = 6.0V$, $A_{V-BTL} = 20dB$, $R_L = 8\Omega$, $f_{IN} = 1kHz$, $C_B = 1.0\mu F$, $R_1 = 301k\Omega$, $R_2 = 78.7k\Omega$ unless otherwise specified. Limits apply for $T_A = 25^\circ C$. See [Figure 2](#)

Symbol	Parameter	Conditions	LM4804		Units (Limits)
			Typical ⁽³⁾	Limit ⁽⁴⁾⁽⁵⁾	
THD+N	Total Harmonic Distortion + Noise	$P_{OUT} = 1.5W$	0.13	0.5	%
ϵ_{OS}	Output Noise	A-Weighted Filter, $V_{IN} = 0V$, Input Referred	22		μV
PSRR	Power Supply Rejection Ratio	$V_{RIPPLE} = 200mV_{p-p}$ $f = 217Hz$ $f = 1kHz$	72 67		dB (min)
V_{FB}	Feedback Pin Reference Voltage		1.24	1.2772 1.2028	V (max) V (min)

Electrical Characteristics $V_{DD} = 3.0V^{(1)(2)}$

The following specifications apply for $V_{DD} = 3.0V$, $V_1 = 6.0V$, $A_{V-BTL} = 20dB$, $R_L = 8\Omega$, $f_{IN} = 1kHz$, $C_B = 1.0\mu F$, $R_1 = 301k\Omega$, $R_2 = 78.7k\Omega$ unless otherwise specified. Limits apply for $T_A = 25^\circ C$.

Symbol	Parameter	Conditions	LM4804		Units (Limits)
			Typical ⁽³⁾	Limit ⁽⁴⁾⁽⁵⁾	
I_{DD}	Quiescent Power Supply Current	$V_{DD} = 3.2V$, $V_{IN} = 0$, $R_{LOAD} = \infty$	19	33	mA (max)
I_{SD}	Shutdown Current	$V_{SHUTDOWN} = GND^{(6)(7)}$	0.1	2	μA (max)
V_{SDIH}	Shutdown Voltage Input High	SD1 SD2		$0.7V_{DD}$ 1.4	V (min)
V_{SDIL}	Shutdown Voltage Input Low	SD1 SD2		$0.15V_{DD}$ 0.4	V (max)
T_{WU}	Wake-up Time	$C_B = 1.0\mu F$	70		msec (max)
V_{OS}	Output Offset Voltage		3	40	mV (max)
TSD	Thermal Shutdown Temperature			125	$^\circ C$ (min))
P_{OUT}	Output Power	THD = 2% (max)	1.8	1.65	W (min)
THD+N	Total Harmonic Distortion + Noise	$P_{OUT} = 1.5W$	0.15	0.5	%
ϵ_{OS}	Output Noise	A-Weighted Filter, $V_{IN} = 0V$, Input Referred	30		μV
PSRR	Power Supply Rejection Ratio	$V_{RIPPLE} = 200mV_{p-p}$ $f = 217Hz$ $f = 1kHz$	73 66		dB (min)
V_{FB}	Feedback Pin Reference Voltage	See ⁽⁸⁾	1.24	1.2772 1.2028	V (max) V (min)

- (1) All voltages are measured with respect to the GND pin, unless otherwise specified.
- (2) *Absolute Maximum Ratings* indicate limits beyond which damage to the device may occur. *Operating Ratings* indicate conditions for which the device is functional, but do not ensure specific performance limits. *Electrical Characteristics* state DC and AC electrical specifications under particular test conditions which specify specific performance limits. This assumes that the device is within the Operating Ratings. Specifications are not ensured for parameters where no limit is given, however, the typical value is a good indication of device performance.
- (3) Typicals are measured at $25^\circ C$ and represent the parametric norm.
- (4) Limits are specified to Texas Instruments' AOQL (Average Outgoing Quality Level).
- (5) Datasheet min/max specification limits are ensured by design, test, or statistical analysis.
- (6) Shutdown current is measured in a normal room environment. The Shutdown pin should be driven as close as possible to V_{in} for minimum shutdown current.
- (7) Shutdown current is measured with components R1 and R2 removed.
- (8) Feedback pin reference voltage is measured with the Audio Amplifier disconnected from the Boost converter (the Boost converter is unloaded).

Typical Performance Characteristics

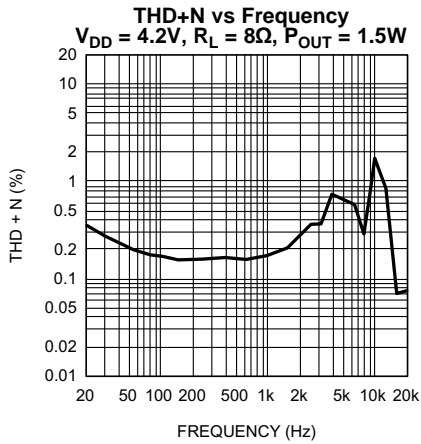

Figure 3.

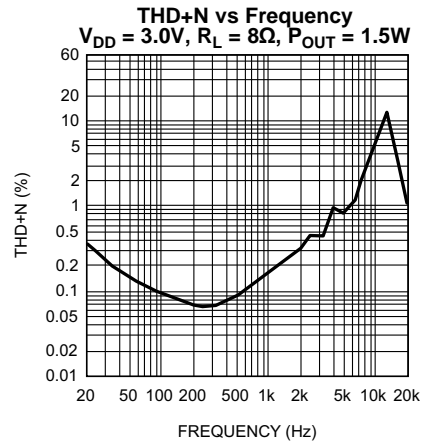

Figure 4.

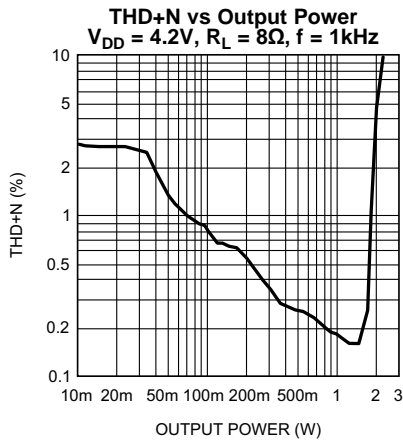

Figure 5.

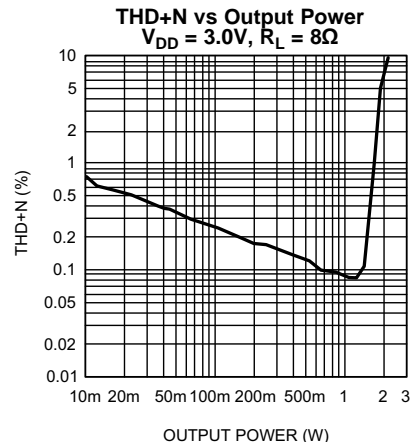

Figure 6.

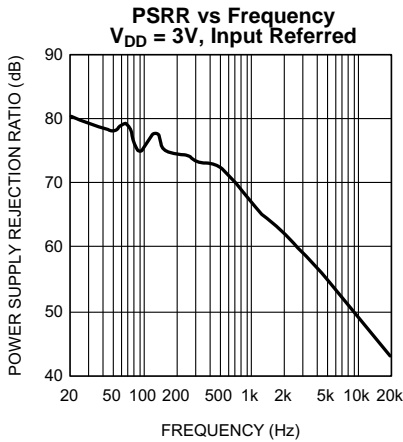

Figure 7.

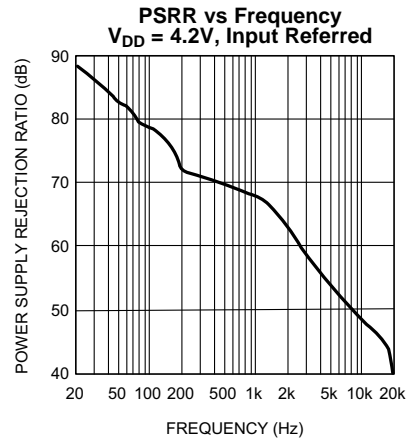

Figure 8.

Typical Performance Characteristics (continued)

Power Supply Current vs Power Supply Voltage
 $R_L = 8\Omega$

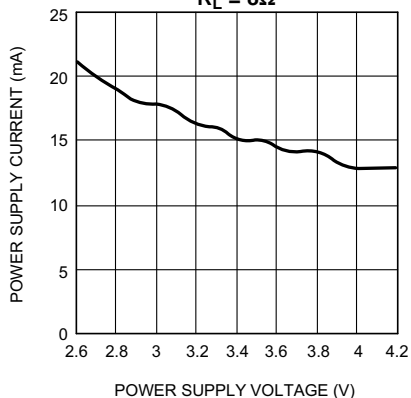

Figure 9.

Power Supply Current vs Output Power

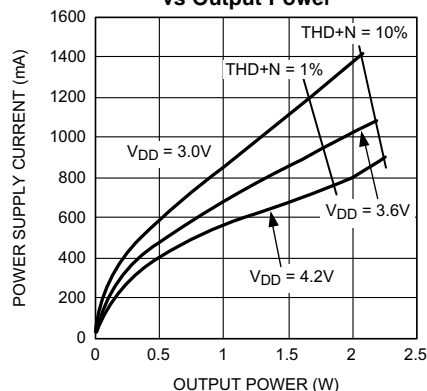

Figure 10.

Output Power vs Power Supply Voltage
 $R_L = 8\Omega$

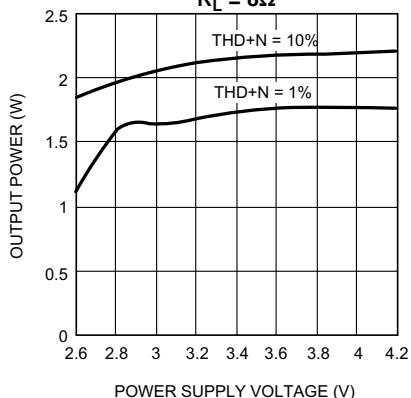

Figure 11.

Amplifier Circuit Dissipation vs Load Dissipation

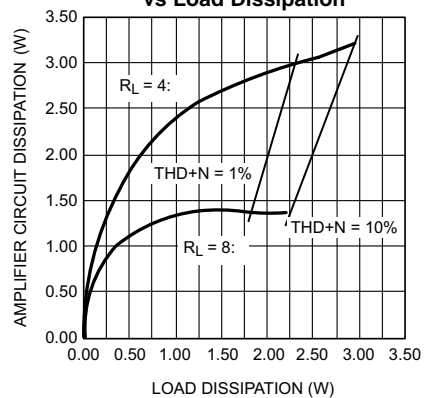

Figure 12.

Efficiency vs V_{IN}
 $V_{OUT} = 5.0V$

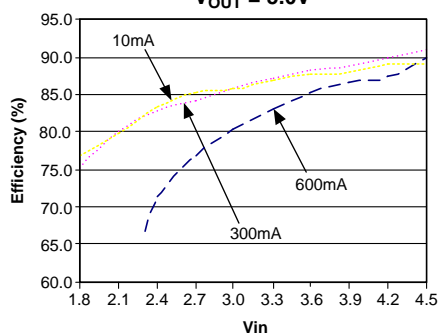

Figure 13.

V_{FB} vs Temperature

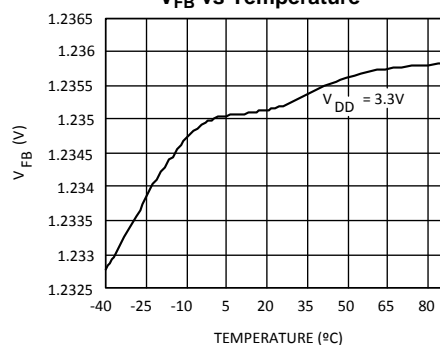

Figure 14.

Typical Performance Characteristics (continued)

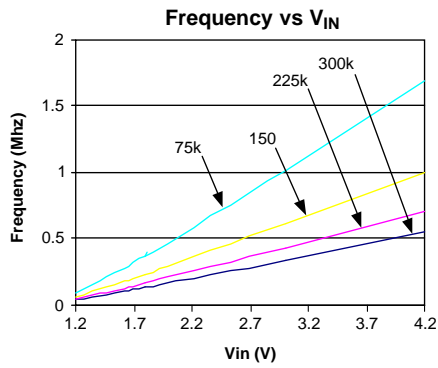

Figure 15.

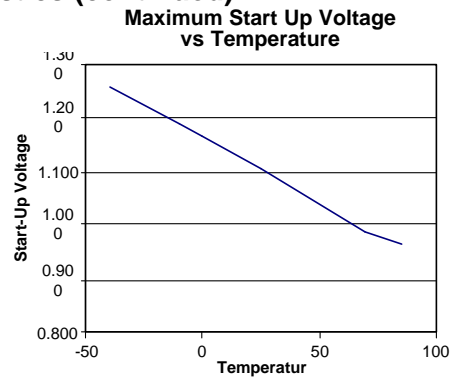

Figure 16.

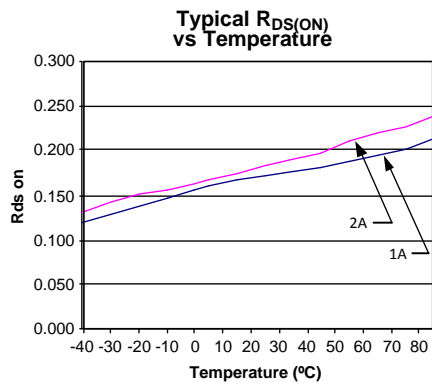

Figure 17.

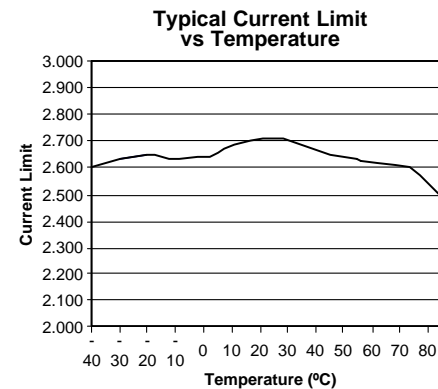

Figure 18.

APPLICATION INFORMATION

BRIDGE CONFIGURATION EXPLANATION

Audio Amplifier portion of the LM4804 has two operational amplifiers internally, allowing for a few different amplifier configurations. The first amplifier's gain is externally configurable, while the second amplifier is internally fixed in a unity-gain, inverting configuration. The closed-loop gain of the first amplifier is set by selecting the ratio of R_f to R_i while the second amplifier's gain is fixed by the two internal 20k Ω resistors. [Figure 2](#) shows that the output of amplifier one serves as the input to amplifier two which results in both amplifiers producing signals identical in magnitude, but out of phase by 180°. Consequently, the differential gain for the IC is

$$A_{VD} = 2 * (R_f/R_i) \quad (1)$$

By driving the load differentially through outputs V_{o1} and V_{o2} , an amplifier configuration commonly referred to as "bridged mode" is established. Bridged mode operation is different from the classical single-ended amplifier configuration where one side of the load is connected to ground.

A bridge amplifier design has a few distinct advantages over the single-ended configuration, as it provides differential drive to the load, thus doubling output swing for a specified supply voltage. Four times the output power is possible as compared to a single-ended amplifier under the same conditions. This increase in attainable output power assumes that the amplifier is not current limited or clipped. In order to choose an amplifier's closed-loop gain without causing excessive clipping, please refer to the **Audio Power Amplifier Design** section.

A bridge configuration also creates a second advantage over single-ended amplifiers. Since the differential outputs, V_{o1} and V_{o2} , are biased at half-supply, no net DC voltage exists across the load. This eliminates the need for an output coupling capacitor which is required in a single supply, single-ended amplifier configuration. Without an output coupling capacitor, the half-supply bias across the load would result in both increased internal IC power dissipation and also possible loudspeaker damage.

AMPLIFIER POWER DISSIPATION

Power dissipation is a major concern when designing a successful amplifier, whether the amplifier is bridged or single-ended. A direct consequence of the increased power delivered to the load by a bridge amplifier is an increase in internal power dissipation. Since the amplifier portion of the LM4804 has two operational amplifiers, the maximum internal power dissipation is 4 times that of a single-ended amplifier. The maximum power dissipation for a given BTL application can be derived from [Equation 2](#).

$$P_{DMAX(AMP)} = 4(V_{DD})^2 / (2\pi^2 R_L) \quad (2)$$

BOOST CONVERTER POWER DISSIPATION

At higher duty cycles, the increased ON time of the FET means the maximum output current will be determined by power dissipation within the LM2731 FET switch. The switch power dissipation from ON-state conduction is calculated by [Equation 3](#).

$$P_{DMAX(SWITCH)} = DC \times I_{IND}(AVE)^2 \times R_{DS(ON)} \quad (3)$$

There will be some switching losses as well, so some derating needs to be applied when calculating IC power dissipation.

TOTAL POWER DISSIPATION

The total power dissipation for the LM4804 can be calculated by adding [Equation 2](#) and [Equation 3](#) together to establish [Equation 4](#):

$$P_{DMAX(TOTAL)} = [4*(V_{DD})^2/2\pi^2 R_L] + [DC \times I_{IND}(AVE)^2 \times R_{DS(ON)}] \quad (4)$$

The result from [Equation 4](#) must not be greater than the power dissipation that results from [Equation 5](#):

$$P_{DMAX} = (T_{JMAX} - T_A) / \theta_{JA} \quad (5)$$

For package LQA28A, $\theta_{JA} = 59^\circ\text{C/W}$. $T_{JMAX} = 125^\circ\text{C}$ for the LM4804. Depending on the ambient temperature, T_A , of the system surroundings, [Equation 5](#) can be used to find the maximum internal power dissipation supported by the IC packaging. If the result of [Equation 4](#) is greater than that of [Equation 5](#), then either the supply voltage must be increased, the load impedance increased or T_A reduced. For the typical application of a 3V power supply, with V_1 set to 6.0V and 8 Ω load, the maximum ambient temperature possible without violating the

maximum junction temperature is approximately TBD°C provided that device operation is around the maximum power dissipation point. Thus, for typical applications, power dissipation is not an issue. Power dissipation is a function of output power and thus, if typical operation is not around the maximum power dissipation point, the ambient temperature may be increased accordingly. Refer to the [Typical Performance Characteristics](#) curves for power dissipation information for lower output levels.

EXPOSED-DAP PACKAGE PCB MOUNTING CONSIDERATIONS

The LM4804's exposed-DAP (die attach paddle) package (LD) provides a low thermal resistance between the die and the PCB to which the part is mounted and soldered. This allows rapid heat transfer from the die to the surrounding PCB copper traces, ground plane, and surrounding air. The LD package should have its DAP soldered to a copper pad on the PCB. The DAP's PCB copper pad may be connected to a large plane of continuous unbroken copper. This plane forms a thermal mass, heat sink, and radiation area. Further detailed and specific information concerning PCB layout, fabrication, and mounting an LD (WQFN) package is available from Texas Instruments' Package Engineering Group under application note AN1187.

SHUTDOWN FUNCTION

In many applications, a microcontroller or microprocessor output is used to control the shutdown circuitry to provide a quick, smooth transition into shutdown. Another solution is to use a single-pole, single-throw switch, in conjunction with an external pull-up resistor to drive both shutdown pins simultaneously. When the switch is closed, the shutdown pin is connected to ground which disables the amplifier. If the switch is open, then the external pull-up resistor to V_{DD} will enable the LM4804. This scheme ensures that the shutdown pins will not float thus preventing unwanted state changes.

EXTERNAL COMPONENT SELECTION

Proper selection of external components in applications using integrated power amplifiers, and switching DC-DC converters, is critical to optimize device and system performance. Consideration to component values must be used to maximize overall system quality.

The best capacitors for use with the switching converter portion of the LM4804 are multi-layer ceramic capacitors. They have the lowest ESR (equivalent series resistance) and highest resonance frequency which makes them optimum for use with high frequency switching converters.

When selecting a ceramic capacitor, only X5R and X7R dielectric types should be used. Other types such as Z5U and Y5F have such severe loss of capacitance due to effects of temperature variation and applied voltage, they may provide as little as 20% of rated capacitance in many typical applications. Always consult capacitor manufacturer's data curves before selecting a capacitor. High-quality ceramic capacitors can be obtained from Taiyo-Yuden, AVX, and Murata.

POWER SUPPLY BYPASSING

As with any amplifier, proper supply bypassing is critical for low noise performance and high power supply rejection. The capacitor location on both the bypass and power supply pins should be as close to the device as possible.

SELECTING THE AUDIO AMPLIFIER'S INPUT CAPACITOR

One of the major considerations is the closedloop bandwidth of the amplifier. To a large extent, the bandwidth is dictated by the choice of external components shown in [Figure 2](#). The input coupling capacitor, C_i , forms a first order high pass filter which limits low frequency response. This value should be chosen based on needed frequency response for a few distinct reasons.

Large input capacitors are both expensive and space hungry for portable designs. Clearly, a certain sized capacitor is needed to couple in low frequencies without severe attenuation. But ceramic speakers used in portable systems, whether internal or external, have little ability to reproduce signals below 100Hz to 150Hz. Thus, using a large input capacitor may not increase actual system performance.

In addition to system cost and size, click and pop performance is effected by the size of the input coupling capacitor, C_i . A larger input coupling capacitor requires more charge to reach its quiescent DC voltage (nominally $1/2 V_{DD}$). This charge comes from the output via the feedback and is apt to create pops upon device enable. Thus, by minimizing the capacitor size based on necessary low frequency response, turn-on pops can be minimized.

SELECTING THE AUDIO AMPLIFIER'S BYPASS CAPACITOR

Besides minimizing the input capacitor size, careful consideration should be paid to the bypass capacitor value. Bypass capacitor, C_B , is the most critical component to minimize turn-on pops since it determines how fast the amplifier turns on. The slower the amplifier's outputs ramp to their quiescent DC voltage (nominally $1/2 V_{DD}$), the smaller the turn-on pop. Choosing C_B equal to $1.0\mu\text{F}$ along with a small value of C_i (in the range of $0.039\mu\text{F}$ to $0.39\mu\text{F}$), should produce a virtually clickless and popless shutdown function. While the device will function properly, (no oscillations or motorboating), with C_B equal to $0.1\mu\text{F}$, the device will be much more susceptible to turn-on clicks and pops. Thus, a value of C_B equal to $1.0\mu\text{F}$ is recommended in all but the most cost sensitive designs.

OPERATING PRINCIPLE

The LM4804 includes step-up DC-DC voltage regulation for battery-powered and low-input voltage systems. It combines a step-up switching regulator, N-channel power MOSFET, built-in current limit, thermal limit, and voltage reference. The switching DC-DC regulator boosts an input voltage between $.8\text{V}$ and 14V to a regulated output voltage between 1.24V and 14V . The LM4804 starts from a low 1.1V input and remains operational down to below $.8\text{V}$.

This device is optimized for use in cellular phones and other applications requiring a small size, low profile, as well as low quiescent current for maximum battery life during stand-by and shutdown.

Additional features include a built-in peak switch current limit, a high-efficiency gated-oscillator topology that offers an output of up to 2A at low output voltages, and thermal protection circuitry.

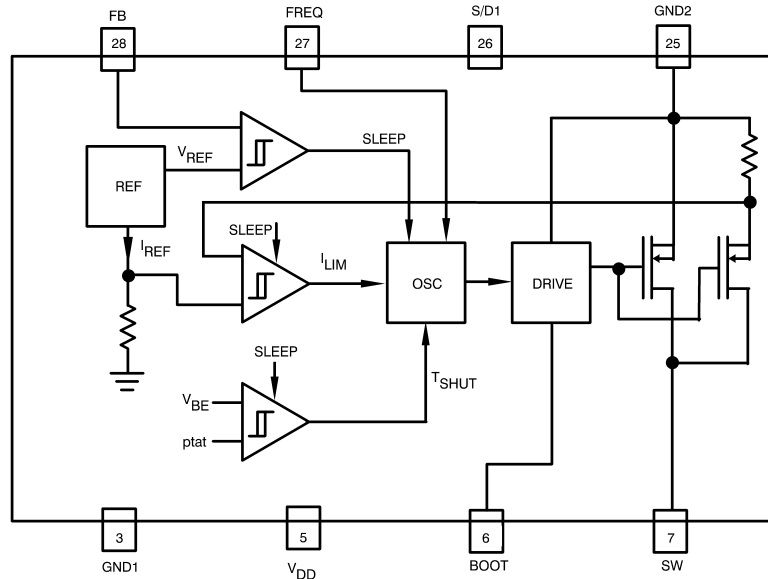

Figure 19. Functional Diagram of the LM4804's Regulator

GATED OSCILLATOR CONTROL SCHEME

The on/off regulation mode of the LM4804, along with its ultra-low quiescent current, results in good efficiency over a very wide load range. The internal oscillator frequency can be programmed using an external resistor to be constant or vary with the battery voltage. Adding a capacitor to program the frequency allows the designer to adjust the duty cycle and optimize it for the application. Adding a resistor in addition to the capacitor allows the duty cycle to dynamically compensate for changes to the input/output voltage ratio. We call this a Ratio Adaptive Gated Oscillator circuit. Using the correct RC components to adjust the oscillator allows the part to run with low ripple and high efficiency over a wide range of loads and input/output voltages.

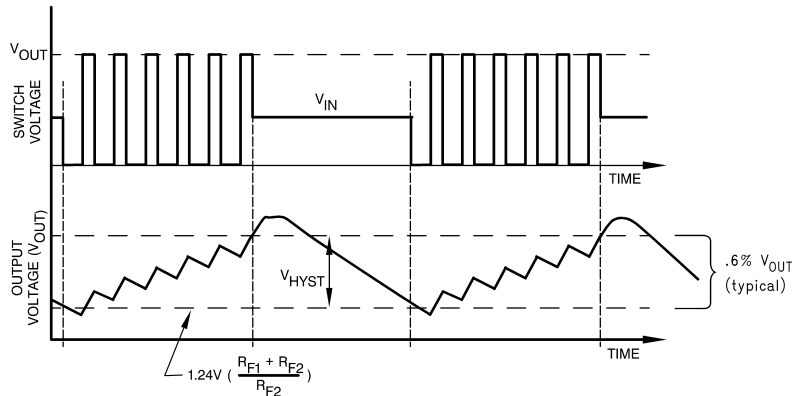

Figure 20. Typical Step-Up Regulator Waveforms

PULSE FREQUENCY MODULATION (PFM)

Pulse Frequency Modulation is typically accomplished by switching continuously until the voltage limit is reached and skipping cycles after that to just maintain it. This results in a somewhat hysteretic mode of operation. The coil stores more energy each cycle as the current ramps up to high levels. When the voltage limit is reached, the system usually overshoots to a higher voltage than required, due to the stored energy in the coil (see [Figure 20](#)). The system will also undershoot somewhat when it starts switching again because it has depleted all the stored energy in the coil and needs to store more energy to reach equilibrium with the load. Larger output capacitors and smaller inductors reduce the ripple in these situations. The frequency being filtered, however, is not the basic switching frequency. It is a lower frequency determined by the load, the input/output voltage and the circuit parameters. This mode of operation is useful in situations where the load variation is significant. Power managed computer systems, for instance, may vary from zero to full load while the system is on and this is usually the preferred regulation mode for such systems.

CYCLE TO CYCLE PFM

When the load doesn't vary over a wide range (like zero to full load), ratio adaptive circuit techniques can be used to achieve cycle to cycle PFM regulation and lower ripple (or smaller output capacitors). The key to success here is matching the duty cycle of the circuit closely to what is required by the input to output voltage ratio. This ratio then needs to be dynamically adjusted for input voltage changes (usually caused by batteries running down). The chosen ratio should allow most of the energy in each switching cycle to be delivered to the load and only a small amount to be stored. When the regulation limit is reached, the overshoot will be small and the system will settle at an equilibrium point where it adjusts the off time in each switching cycle to meet the current requirements of the load. The off time adjustment is done by exceeding the regulation limit during each switching cycle and waiting until the voltage drops below the limit again to start the next switching cycle. The current in the coil never goes to zero like it frequently does in the hysteretic operating mode of circuits with wide load variations or duty cycles that aren't matched to the input/output voltage ratio. Optimizing the duty cycle for a given set of input/output voltages conditions can be done by using the circuit values in the Application Notes.

LOW VOLTAGE START-UP

The LM4804 can start-up from voltages as low as 1.1 volts. On start-up, the control circuitry switches the N-channel MOSFET continuously until the output reaches 3 volts. After this output voltage is reached, the normal step-up regulator feedback and gated oscillator control scheme take over. Once the device is in regulation, it can operate down to below .8V input, since the internal power for the IC can be boot-strapped from the output using the V_{DD} pin.

SHUT DOWN

The LM4804 features a shutdown mode that reduces the quiescent current to less than a 2.5uA over temperature. This extends the life of the battery in battery powered applications. During shutdown, all feedback and control circuitry is turned off. The regulator's output voltage drops to one diode drop below the input voltage. Entry into the shutdown mode is controlled by the active-low logic input pin S/D1 (pin 26). When the logic input to this pin is pulled below 0.15V_{DD}, the device goes into shutdown mode. The logic input to this pin should be above 0.7V_{DD} for the device to work in normal step-up mode.

SELECTING OUTPUT CAPACITOR (C_O) FOR BOOST CONVERTER

A single ceramic capacitor of value 4.7μF to 10μF will provide sufficient output capacitance for most applications. If larger amounts of capacitance are desired for improved line support and transient response, tantalum capacitors can be used. Aluminum electrolytics with ultra low ESR such as Sanyo Oscon can be used, but are usually prohibitively expensive. Typical Al electrolytic capacitors are not suitable for switching frequencies above 500 kHz due to significant ringing and temperature rise due to self-heating from ripple current. An output capacitor with excessive ESR can also reduce phase margin and cause instability.

In general, if electrolytics are used, it is recommended that they be paralleled with ceramic capacitors to reduce ringing, switching losses, and output voltage ripple.

INTERNAL CURRENT LIMIT AND THERMAL PROTECTION

An internal cycle-by-cycle current limit serves as a protection feature. This is set high enough (2.85A typical, approximately 4A maximum) so as not to come into effect during normal operating conditions. An internal thermal protection circuit disables the MOSFET power switch when the junction temperature (T_J) exceeds about 160°C. The switch is re-enabled when T_J drops below approximately 135°C.

NON-LINEAR EFFECT

The LM4804 takes advantage of a non-linear effect that allows for the duty cycle to be programmable. The C3 capacitor is used to dump charge on the FREQ pin in order to manipulate the duty cycle of the internal oscillator. The part is being tricked to behave in a certain manner, in the effort to make this Pulse Frequency Modulated (PFM) boost switching regulator behave as a Pulse Width Modulated (PWM) boost switching regulator.

CHOOSING THE CORRECT C3 CAPACITOR

The C3 capacitor allows for the duty cycle of the internal oscillator to be programmable. Choosing the correct C3 capacitor to get the appropriate duty cycle for a particular application circuit is a trial and error process. The non-linear effect that C3 produces is dependent on the input voltage and output voltage values. The correct C3 capacitor for particular input and output voltage values cannot be calculated. Choosing the correct C3 capacitance is best done by trial and error, in conjunction with the checking of the inductor peak current to make sure your not too close to the current limit of the device. As the C3 capacitor value increases, so does the duty cycle. And conversely as the C3 capacitor value decreases, the duty cycle decreases. An incorrect choice of the C3 capacitor can result in the part prematurely tripping the current limit and/or double pulsing, which could lead to the output voltage not being stable.

SETTING THE OUTPUT VOLTAGE

The output voltage of the step-up regulator can be set by connecting a feedback resistive divider made of R_{F1} and R_{F2}. The resistor values are selected as follows:

$$R_1 = R_2[(V_{OUT}/1.24) - 1] \quad (6)$$

A value of 50k to 100k is suggested for R₂. Then, R₁ can be selected using [Equation 6](#).

V_{DD} SUPPLY

The V_{DD} supply must be between 3 to 5 volts for the LM4804. This voltage can be bootstrapped from a much lower input voltage by simply connecting the V_{DD} pin to V_{OUT}. In the event that the V_{DD} supply voltage is not a low ripple voltage source (less than 200 millivolts), it may be advisable to use an RC filter to clean it up. Excessive ripple on V_{DD} may reduce the efficiency.

SETTING THE SWITCHING FREQUENCY

The switching frequency of the oscillator is selected by choosing an external resistor (R3) connected between V_{IN} and the FREQ pin. See the graph titled "Frequency vs V_{IN}" in the [Typical Performance Characteristics](#) section of the data sheet for choosing the R3 value to achieve the desired switching frequency. A high switching frequency allows the use of very small surface mount inductors and capacitors and results in a very small solution size. A switching frequency between 300kHz and 2MHz is recommended.

OUTPUT DIODE SELECTION

A Schottky diode should be used for the output diode. The forward current rating of the diode should be higher than the peak input current, and the reverse voltage rating must be higher than the output voltage. Do not use ordinary rectifier diodes, since slow switching speeds and long recovery times cause the efficiency and the load regulation to suffer. [Table 1](#) shows a list of the diode manufacturers.

WQFN PACKAGE DEVICES

The LM4804 is offered in the 14 lead WQFN surface mount package to allow for increased power dissipation compared to the MSOP-8. For details of the thermal performance as well as mounting and soldering specifications, refer to [Application Note AN-1187](#).

RECOMMENDED PRINTED CIRCUIT BOARD LAYOUT

[Figure 22](#) through [Figure 27](#) show the recommended four-layer PC board layout that is optimized for the LQ-packaged, 3V 1.7W LM4804 mono-BTL audio amplifier and its associated external components. This circuit is designed for use with an external 3V to 4.2V supply and speakers with 4Ω or higher impedance (8Ω nominal).

The LM4804 circuit board is easy to use. Apply between 3V and 4.2V (equivalent to, respectfully, a discharged or a fully charged Li-ion or NMH battery) and ground to JP2's V_{DD} and GND pins, respectively. Connect a speaker with an impedance of 4Ω or greater (8Ω nominal) between the board's VO1 (-) and VO2 (+) pins. An audio signal is applied to JP1 between the V_{IN} (+) and GND (-) pins.

The circuit board is configured for a gain of 20 or 26dB (VO2 -VO1 with respect to VIN). An inverting gain of -10 at VO1 is set by R_f (200kΩ) versus R_i (20kΩ). The extra gain of 2 is a product of the BTL output (VO2 - VO1). Gain can be modified by changing R_f's value with respect to R_i.

Table 1. Suggested Manufacturers List

Inductors	Capacitors	Diodes
Coilcraft Tel: (800) 322-2645 Fax: (708) 639-1469	Sprague/ Vishay Tel: (207) 324-4140 Fax: (207) 324-7223	Motorola Tel: (800) 521-6274 Fax: (602) 244-6609
Coiltronics Tel: (407) 241-7876 Fax: (407) 241-9339	Kemet Tel: (864) 963-6300 Fax: (864) 963-6521	International Rectifier (IR) Tel: (310) 322-3331 Fax: (310) 322-3332
Pulse Engineering Tel: (619) 674-8100 Fax: (619) 674-8262	Nichicon Tel: (847) 843-7500 Fax: (847) 843-2798	General Semiconductor Tel: (516) 847-3222 Fax: (516) 847-3150

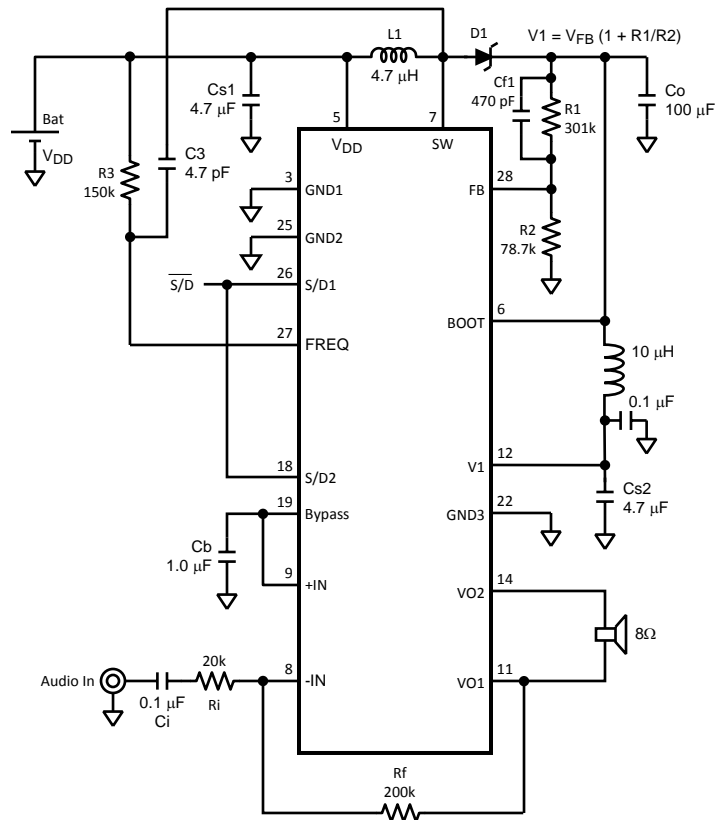

Figure 21. Demo Board Reference Schematic

Demonstration Board Layout

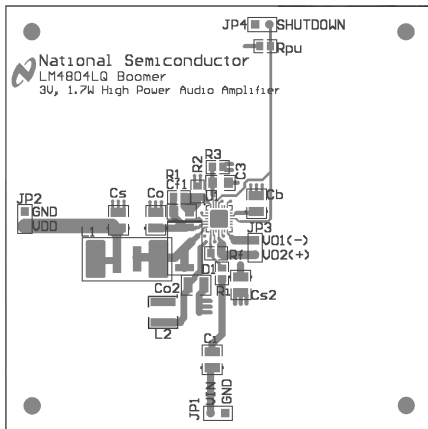

Figure 22. Top Trace Layer Silkscreen

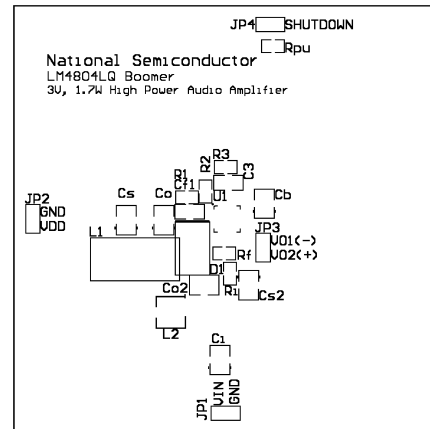

Figure 23. Top Layer Silkscreen

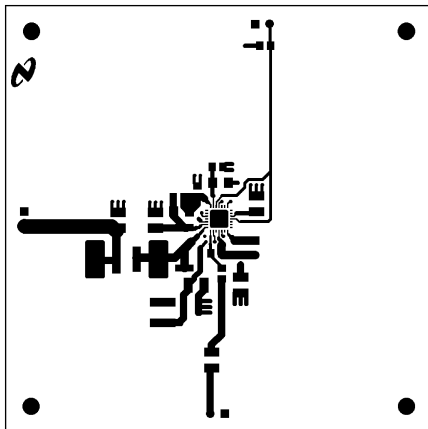

Figure 24. Top Trace Layer

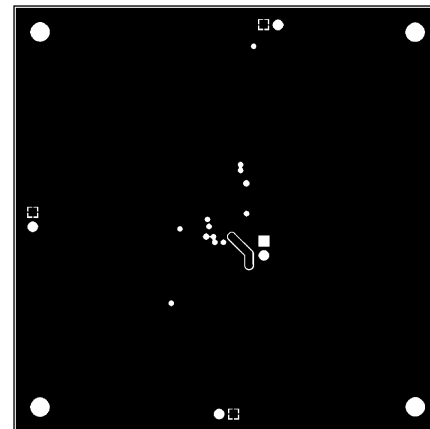

Figure 25. Upper Internal GND Layer

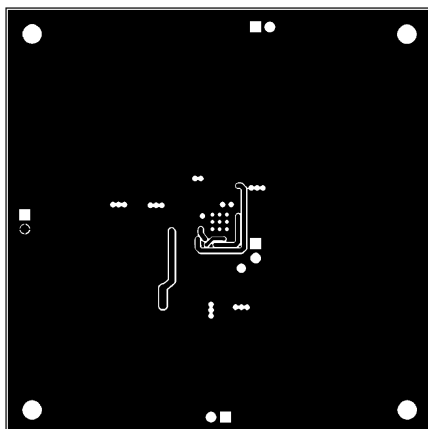

Figure 26. Lower Internal V_{DD} Layer

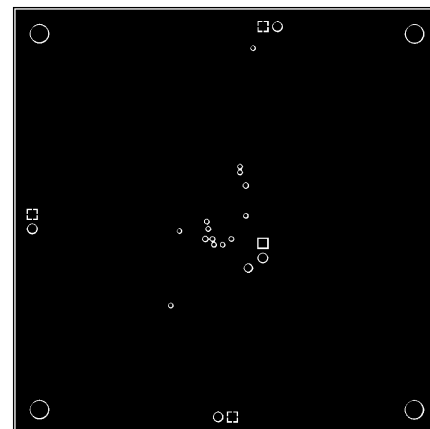

Figure 27. Bottom Trace Layer with GND Plane

Revision History

Rev	Date	Description
1.0	6/14/05	Under SHUTDOWN (Apps section), changed EN to S/D1 and (pin- 2) into pin 26, then re-released D/S to the WEB.
C	4/08/13	Changed layout of National Data Sheet to TI format.

PACKAGING INFORMATION

Orderable Device	Status (1)	Package Type	Package Drawing	Pins	Package Qty	Eco Plan (2)	Lead/Ball Finish (6)	MSL Peak Temp (3)	Op Temp (°C)	Device Marking (4/5)	Samples
LM4804LQ/NOPB	LIFEBUY	WQFN	NJB	28		TBD	Call TI	Call TI		L4804LQ	

(1) The marketing status values are defined as follows:

ACTIVE: Product device recommended for new designs.

LIFEBUY: TI has announced that the device will be discontinued, and a lifetime-buy period is in effect.

NRND: Not recommended for new designs. Device is in production to support existing customers, but TI does not recommend using this part in a new design.

PREVIEW: Device has been announced but is not in production. Samples may or may not be available.

OBSOLETE: TI has discontinued the production of the device.

(2) **RoHS:** TI defines "RoHS" to mean semiconductor products that are compliant with the current EU RoHS requirements for all 10 RoHS substances, including the requirement that RoHS substance do not exceed 0.1% by weight in homogeneous materials. Where designed to be soldered at high temperatures, "RoHS" products are suitable for use in specified lead-free processes. TI may reference these types of products as "Pb-Free".

RoHS Exempt: TI defines "RoHS Exempt" to mean products that contain lead but are compliant with EU RoHS pursuant to a specific EU RoHS exemption.

Green: TI defines "Green" to mean the content of Chlorine (Cl) and Bromine (Br) based flame retardants meet JS709B low halogen requirements of <=1000ppm threshold. Antimony trioxide based flame retardants must also meet the <=1000ppm threshold requirement.

(3) MSL, Peak Temp. - The Moisture Sensitivity Level rating according to the JEDEC industry standard classifications, and peak solder temperature.

(4) There may be additional marking, which relates to the logo, the lot trace code information, or the environmental category on the device.

(5) Multiple Device Markings will be inside parentheses. Only one Device Marking contained in parentheses and separated by a "~" will appear on a device. If a line is indented then it is a continuation of the previous line and the two combined represent the entire Device Marking for that device.

(6) Lead/Ball Finish - Orderable Devices may have multiple material finish options. Finish options are separated by a vertical ruled line. Lead/Ball Finish values may wrap to two lines if the finish value exceeds the maximum column width.

Important Information and Disclaimer:The information provided on this page represents TI's knowledge and belief as of the date that it is provided. TI bases its knowledge and belief on information provided by third parties, and makes no representation or warranty as to the accuracy of such information. Efforts are underway to better integrate information from third parties. TI has taken and continues to take reasonable steps to provide representative and accurate information but may not have conducted destructive testing or chemical analysis on incoming materials and chemicals. TI and TI suppliers consider certain information to be proprietary, and thus CAS numbers and other limited information may not be available for release.

In no event shall TI's liability arising out of such information exceed the total purchase price of the TI part(s) at issue in this document sold by TI to Customer on an annual basis.

NJB0028A

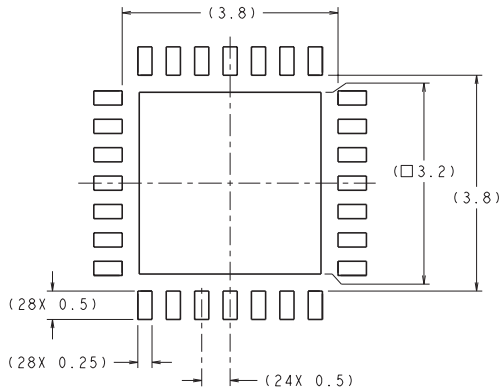

RECOMMENDED LAND PATTERN
1:1 RATION WITH PKG SOLDER PADS

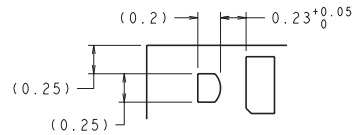

DETAIL A
SCALE: 40X

DIMENSIONS ARE IN MILLIMETERS

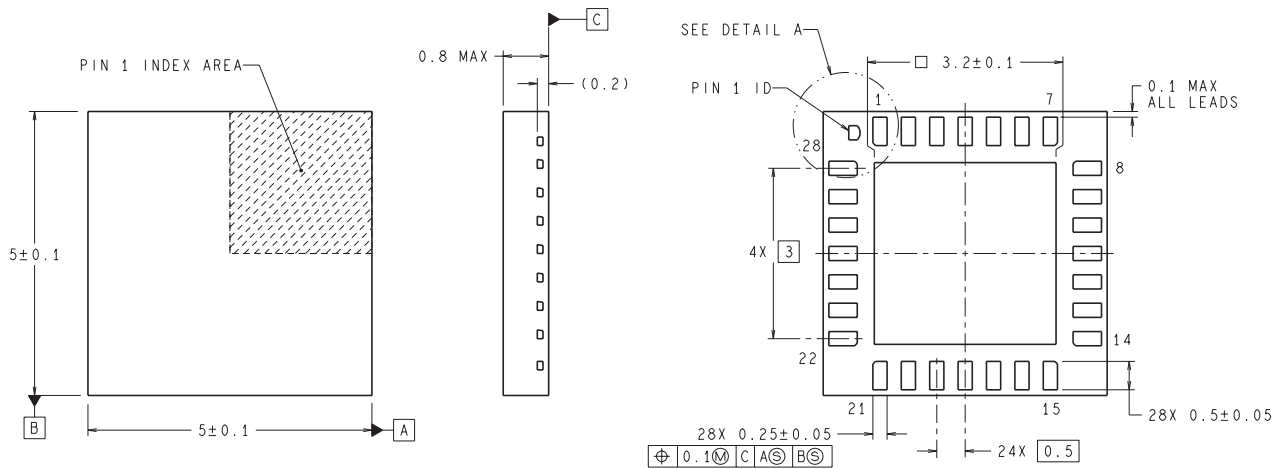

LQA28A (REV B)

IMPORTANT NOTICE

Texas Instruments Incorporated (TI) reserves the right to make corrections, enhancements, improvements and other changes to its semiconductor products and services per JESD46, latest issue, and to discontinue any product or service per JESD48, latest issue. Buyers should obtain the latest relevant information before placing orders and should verify that such information is current and complete.

TI's published terms of sale for semiconductor products (<http://www.ti.com/sc/docs/stdterms.htm>) apply to the sale of packaged integrated circuit products that TI has qualified and released to market. Additional terms may apply to the use or sale of other types of TI products and services.

Reproduction of significant portions of TI information in TI data sheets is permissible only if reproduction is without alteration and is accompanied by all associated warranties, conditions, limitations, and notices. TI is not responsible or liable for such reproduced documentation. Information of third parties may be subject to additional restrictions. Resale of TI products or services with statements different from or beyond the parameters stated by TI for that product or service voids all express and any implied warranties for the associated TI product or service and is an unfair and deceptive business practice. TI is not responsible or liable for any such statements.

Buyers and others who are developing systems that incorporate TI products (collectively, "Designers") understand and agree that Designers remain responsible for using their independent analysis, evaluation and judgment in designing their applications and that Designers have full and exclusive responsibility to assure the safety of Designers' applications and compliance of their applications (and of all TI products used in or for Designers' applications) with all applicable regulations, laws and other applicable requirements. Designer represents that, with respect to their applications, Designer has all the necessary expertise to create and implement safeguards that (1) anticipate dangerous consequences of failures, (2) monitor failures and their consequences, and (3) lessen the likelihood of failures that might cause harm and take appropriate actions. Designer agrees that prior to using or distributing any applications that include TI products, Designer will thoroughly test such applications and the functionality of such TI products as used in such applications.

TI's provision of technical, application or other design advice, quality characterization, reliability data or other services or information, including, but not limited to, reference designs and materials relating to evaluation modules, (collectively, "TI Resources") are intended to assist designers who are developing applications that incorporate TI products; by downloading, accessing or using TI Resources in any way, Designer (individually or, if Designer is acting on behalf of a company, Designer's company) agrees to use any particular TI Resource solely for this purpose and subject to the terms of this Notice.

TI's provision of TI Resources does not expand or otherwise alter TI's applicable published warranties or warranty disclaimers for TI products, and no additional obligations or liabilities arise from TI providing such TI Resources. TI reserves the right to make corrections, enhancements, improvements and other changes to its TI Resources. TI has not conducted any testing other than that specifically described in the published documentation for a particular TI Resource.

Designer is authorized to use, copy and modify any individual TI Resource only in connection with the development of applications that include the TI product(s) identified in such TI Resource. NO OTHER LICENSE, EXPRESS OR IMPLIED, BY ESTOPPEL OR OTHERWISE TO ANY OTHER TI INTELLECTUAL PROPERTY RIGHT, AND NO LICENSE TO ANY TECHNOLOGY OR INTELLECTUAL PROPERTY RIGHT OF TI OR ANY THIRD PARTY IS GRANTED HEREIN, including but not limited to any patent right, copyright, mask work right, or other intellectual property right relating to any combination, machine, or process in which TI products or services are used. Information regarding or referencing third-party products or services does not constitute a license to use such products or services, or a warranty or endorsement thereof. Use of TI Resources may require a license from a third party under the patents or other intellectual property of the third party, or a license from TI under the patents or other intellectual property of TI.

TI RESOURCES ARE PROVIDED "AS IS" AND WITH ALL FAULTS. TI DISCLAIMS ALL OTHER WARRANTIES OR REPRESENTATIONS, EXPRESS OR IMPLIED, REGARDING RESOURCES OR USE THEREOF, INCLUDING BUT NOT LIMITED TO ACCURACY OR COMPLETENESS, TITLE, ANY EPIDEMIC FAILURE WARRANTY AND ANY IMPLIED WARRANTIES OF MERCHANTABILITY, FITNESS FOR A PARTICULAR PURPOSE, AND NON-INFRINGEMENT OF ANY THIRD PARTY INTELLECTUAL PROPERTY RIGHTS. TI SHALL NOT BE LIABLE FOR AND SHALL NOT DEFEND OR INDEMNIFY DESIGNER AGAINST ANY CLAIM, INCLUDING BUT NOT LIMITED TO ANY INFRINGEMENT CLAIM THAT RELATES TO OR IS BASED ON ANY COMBINATION OF PRODUCTS EVEN IF DESCRIBED IN TI RESOURCES OR OTHERWISE. IN NO EVENT SHALL TI BE LIABLE FOR ANY ACTUAL, DIRECT, SPECIAL, COLLATERAL, INDIRECT, PUNITIVE, INCIDENTAL, CONSEQUENTIAL OR EXEMPLARY DAMAGES IN CONNECTION WITH OR ARISING OUT OF TI RESOURCES OR USE THEREOF, AND REGARDLESS OF WHETHER TI HAS BEEN ADVISED OF THE POSSIBILITY OF SUCH DAMAGES.

Unless TI has explicitly designated an individual product as meeting the requirements of a particular industry standard (e.g., ISO/TS 16949 and ISO 26262), TI is not responsible for any failure to meet such industry standard requirements.

Where TI specifically promotes products as facilitating functional safety or as compliant with industry functional safety standards, such products are intended to help enable customers to design and create their own applications that meet applicable functional safety standards and requirements. Using products in an application does not by itself establish any safety features in the application. Designers must ensure compliance with safety-related requirements and standards applicable to their applications. Designer may not use any TI products in life-critical medical equipment unless authorized officers of the parties have executed a special contract specifically governing such use. Life-critical medical equipment is medical equipment where failure of such equipment would cause serious bodily injury or death (e.g., life support, pacemakers, defibrillators, heart pumps, neurostimulators, and implantables). Such equipment includes, without limitation, all medical devices identified by the U.S. Food and Drug Administration as Class III devices and equivalent classifications outside the U.S.

TI may expressly designate certain products as completing a particular qualification (e.g., Q100, Military Grade, or Enhanced Product). Designers agree that it has the necessary expertise to select the product with the appropriate qualification designation for their applications and that proper product selection is at Designers' own risk. Designers are solely responsible for compliance with all legal and regulatory requirements in connection with such selection.

Designer will fully indemnify TI and its representatives against any damages, costs, losses, and/or liabilities arising out of Designer's non-compliance with the terms and provisions of this Notice.