

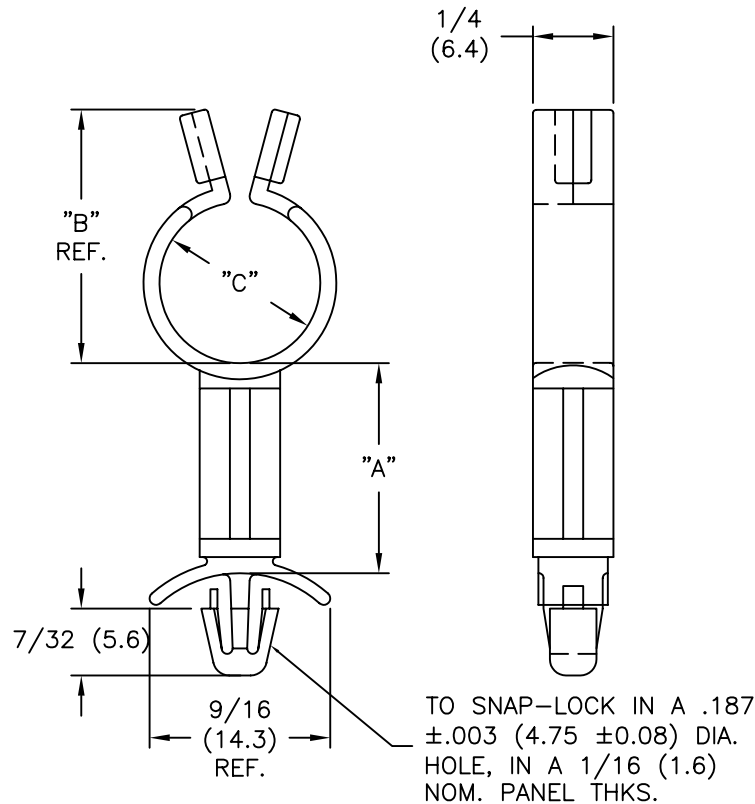

**THE DATASHEET OF
SLCS-370-3-01**





PART NO.	"B"	MAX. BUNDLE "C" LOCKED
SLCS-250	0.53(13.5)	3/16(4.8)
SLCS-370	0.66(16.8)	5/16(7.9)
SLCS-500	0.79(20.1)	7/16(11.1)
SLCS-750	1.04(26.4)	11/16(17.5)

SUFFIX	"A" ±.015(0.4)
-3	3/16(4.8)
-4	1/4(6.4)
-6	3/8(9.5)
-8	1/2(12.7)
-10	5/8(15.9)
*-12	3/4(19.1)
*-14	7/8(22.2)
-16	1.0(25.4)

NOTES:

1. MATERIAL: NYLON 6/6 UL 94 V-2 (RMS-01).
2. COLOR: NATURAL.
3. NYLON 6/6 UL 94 V-0 (RMS-19).
AVAILABLE BY SPECIAL ORDER.
4. NYLON 6/6 UL 94 V-2, HEAT STABILIZED (RMS-109),
AVAILABLE BY SPECIAL ORDER ONLY.
TO ORDER ADD SUFFIX "-109" TO P/N.

*PARTS AVAILABLE BY SPECIAL ORDER ONLY

TITLE: STANDOFF LOCK CLIP SERIES			DWG IN IN (MM)		FINAL		
D	SEE ECN #1288 FOR CHANGES	SK 02.13.07	FILE # SLCS	DWN: J.B.	APP:	PART # SEE CHART	PRINT TYPE CA
C	SEE ECN #914 FOR CHANGES	SK 01.14.05	MAT'L: SEE NOTES	DT: 11-30-95	DT:		
B	SEE ECN #818 FOR CHANGES	SM 10.01.04	RE: RICHCO, INC.	RICHCO INC. PO BOX 804238, CHICAGO, 60680 (773) 539-4060			
A	CHANGED FILE NUMBER	SM 05.31.01					
REV	DESCRIPTION	ENGR DATE	TOLERANCES UNLESS NOTED .XX=±.010 .XXX=±.005 FRAC=±1/64 ANG=±1°				