



**THE DATASHEET OF
LM3639AYFQT**



LM3639A Single Chip 40V Backlight + 1.5A Flash LED Driver

Check for Samples: [LM3639A](#)

FEATURES

- Single Chip White LED Flash and Backlight Driver
- 1.5A Flash LED Current
- Dual String Backlight Control (40V Max V_{OUT})
- 128 Level Exponential and Linear Brightness Control
- PWM Input for CABC
- Programmable Over-Voltage Protection (Backlight)
- Programmable Current Limit (Flash)
- Programmable Switching Frequency
- Optimized Flash Current During Low-Battery Conditions

APPLICATIONS

- White LED Backlit Display Power
- White LED Camera Flash Power

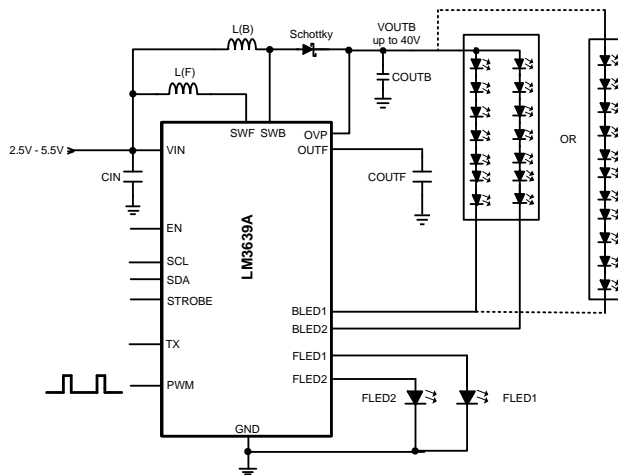

DESCRIPTION

The LM3639A is a single-chip white LED Camera Flash Driver + LCD Display Backlight Driver. The low-voltage, high-current flash LED driver is a synchronous boost which provides the power for a single flash LED at up to 1.5A or dual LEDs at up to 750 mA each. The high-voltage backlight driver is a dual-output asynchronous boost which powers dual LED strings at up to 40V and 30 mA per string. An adaptive regulation method in both boost converters regulates the headroom voltage across the respective source/sink to ensure the LED current remains in regulation while maximizing efficiency. The LM3639A's flash driver is a 2MHz or 4MHz fixed-frequency synchronous boost converter plus 1.5A constant current driver for a high-current white LED. The high-side current source allows for grounded cathode LED operation providing Flash current up to 1.5A. An adaptive regulation method ensures the current source remains in regulation and maximizes efficiency.

The device is controlled by an I²C-compatible interface. Features for the flash LED driver include a hardware flash enable (STROBE) allowing a logic input to trigger the flash pulse, and a TX input for synchronization to RF power amplifier events or other high current conditions. Features for the LCD backlight driver include a PWM input for content adjustable backlight control, 128 exponential or linear brightness levels, programmable over-voltage protection, and selectable switching frequency (500 kHz or 1 MHz).

The device is available in a tiny 1.790 mm x 2.165 mm x 0.6 mm 20-bump, 0.4 mm pitch DSBGA package and operates over the -40°C to +85°C temperature range.



Please be aware that an important notice concerning availability, standard warranty, and use in critical applications of Texas Instruments semiconductor products and disclaimers thereto appears at the end of this data sheet.

All trademarks are the property of their respective owners.



This integrated circuit can be damaged by ESD. Texas Instruments recommends that all integrated circuits be handled with appropriate precautions. Failure to observe proper handling and installation procedures can cause damage.

ESD damage can range from subtle performance degradation to complete device failure. Precision integrated circuits may be more susceptible to damage because very small parametric changes could cause the device not to meet its published specifications.

Connection Diagram

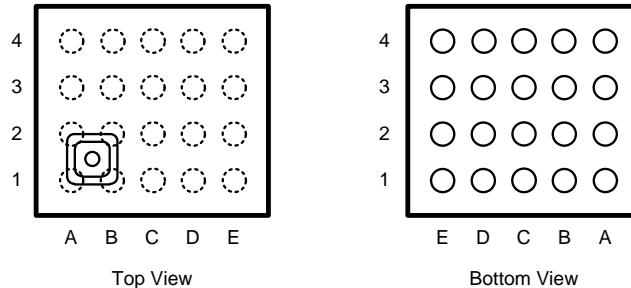

**Figure 1. 20-Bump, 0.4 mm Pitch DSBGA Package
YFQ0020HGA**

PIN DESCRIPTIONS

TERMINAL		I/O	DESCRIPTION
NAME	NO.		
FLED1	A1	Output	High Side Current Source Output for Flash LED1.
FLED2	B1	Output	High Side Current Source Output for Flash LED2.
OUTF (x2)	A2/B2	Output	Flash LED Boost Output. Connect a 10 μ F ceramic capacitor between this pin GND.
SWF (x2)	A3/B3	Output	Drain Connection for Internal NMOS and Synchronous PMOS Switches. Connect the Flash LED Boost Inductor to SWF.
GND (x3)	A4/B4/E3		Ground
TX	C2	Input	Power Amplifier Synchronization Input. The TX pin has a 300 k Ω pull-down resistor connected to GND.
STROBE	C3	Input	Active High Hardware Flash Enable. Drive STROBE high to turn on Flash pulse. STROBE overrides TORCH. The STROBE pin has a 300 k Ω pull-down resistor connected to GND.
VIN	C4	Input	Input Voltage Connection. Connect IN to the input supply, and bypass to GND with a 10 μ F or larger ceramic capacitor.
SDA	D3	Input	Serial Data Input/Output.
SCL	D2	Input	Serial Clock Input.
EN	C1	Input	Enable Pin. High = Standby, Low = Shutdown/Reset.
SWB	E4	Input	Drain Connection for internal NFET. Connect SWB to the junction of the backlight boost inductor and the Schottky diode anode.
PWM	D4	Input	PWM Brightness Control Input for backlight current control. The PWM pin has a 300 k Ω pull-down resistor connected to GND.
BLED1	D1	Input	Input Terminal to Backlight LED String Current Sink #1 (40V max). The boost converter regulates the minimum of BLED1 and BLED2 to 400 mV.
BLED2	E1	Input	Input Terminal to Backlight LED String Current Sink #2 (40V max). The boost converter regulates the minimum of BLED1 and BLED2 to 400 mV.
OVP	E2	Input	Over-Voltage Sense Input for Backlight Boost. Connect to the positive terminal of (COUTB).

ABSOLUTE MAXIMUM RATINGS ⁽¹⁾

V _{IN} ^{(2) (3)}	-0.3V to 6V
SWF, OUTF, FLED1, FLED2, EN, PWM, SCL, SDA, TX, STROBE ⁽²⁾	-0.3V to the lesser of (V _{IN} +0.3V) w/ 6V max
SWB, OVP, BLED1, BLED2 ⁽²⁾	-0.3V to +45V
Storage Temperature Range	-65°C to +150°C

- (1) Absolute Maximum Ratings indicate limits beyond which damage to the device may occur. Operating Ratings are conditions under which operation of the device is ensured. Operating Ratings do not imply ensured performance limits. For ensured performance limits and associated test conditions, see the Electrical Characteristics table.
- (2) All voltages are with respect to the potential at the GND pin.
- (3) V_{IN} can be below -0.3V if the current out of the pin is limited to 500 μ A.

OPERATING RATINGS ^{(1) (2)}

V _{IN}	2.5V to 5.5V
Junction Temperature (T _J)	-40°C to +125°C
Ambient Temperature (T _A) ⁽³⁾	-40°C to +85°C

- (1) Absolute Maximum Ratings indicate limits beyond which damage to the device may occur. Operating Ratings are conditions under which operation of the device is ensured. Operating Ratings do not imply ensured performance limits. For ensured performance limits and associated test conditions, see the Electrical Characteristics table.
- (2) All voltages are with respect to the potential at the GND pin.
- (3) In applications where high power dissipation and/or poor package thermal resistance is present, the maximum ambient temperature may have to be derated. Maximum ambient temperature (T_{A-MAX}) is dependent on the maximum operating junction temperature (T_{J-MAX-OP} = +125°C), the maximum power dissipation of the device in the application (P_{D-MAX}), and the junction-to-ambient thermal resistance of the part/package in the application (θ_{JA}), as given by the following equation: T_{A-MAX} = T_{J-MAX-OP} - ($\theta_{JA} \times P_{D-MAX}$).

THERMAL PROPERTIES

Thermal Junction-to-Ambient Resistance (θ_{JA}) ⁽¹⁾	48.8°C/W
---	----------

- (1) Junction-to-ambient thermal resistance (θ_{JA}) is taken from a thermal modeling result, performed under the conditions and guidelines set forth in the JEDEC standard JESD51-7. The test board is a 4-layer FR-4 board measuring 102mm x 76mm x 1.6mm with a 2 x 1 array of thermal vias. The ground plane on the board is 50mm x 50mm. Thickness of copper layers are 36 μ m/18 μ m/18 μ m/36 μ m (1.5oz/1oz/1oz/1.5oz). Ambient temperature in simulation is 22°C in still air. Power dissipation is 1W. In applications where high maximum power dissipation exists special care must be paid to thermal dissipation issues.

ELECTRICAL CHARACTERISTICS (1) (2)

Limits in standard typeface are for $T_A = +25^\circ\text{C}$. Limits in **boldface** type apply over the full operating ambient temperature range ($-40^\circ\text{C} \leq T_A \leq +85^\circ\text{C}$). Unless otherwise specified, $V_{IN} = 3.6\text{V}$.

Symbol	Parameter	Test Conditions	Min	Typ	Max	Unit	
V_{IN}	Input Voltage Range		2.5	3.6	5.5	V	
I_{SHDN}	Shutdown Supply Current	Device Shutdown, EN = GND		1	3.5	μA	
I_{SB}	Standby Supply Current	Device Disabled via I ² C EN = VIN		1	4		
Low Voltage Boost Specifications (Flash Driver)							
$I_{FLED1} + I_{FLED2}$	Current Source Accuracy	$2.7\text{V} \leq V_{IN} \leq 5.5\text{V}$	750 mA Flash Current Setting	-7%	1.5	+7%	A
			28.125 mA Torch Current Setting, per current source	-10%	56.25	+10%	mA
V_{HR1}, V_{HR2}	Regulated Headroom Voltage	For 750 mA Flash Current Setting			315		mV
		For 28.125 mA Torch Current Setting			180		
V_{OVP}	Output Over-Voltage Protection Trip Point	ON Threshold		4.87	5	5.10	V
		OFF Threshold		4.71	4.88	4.98	
R_{PMOS}	PMOS Switch On-Resistance	$I_{PMOS} = 1\text{A}$		85		m Ω	
R_{NMOS}	NMOS Switch On-Resistance	$I_{NMOS} = 1\text{A}$		75			
I_{CL}	Switch Current Limit	$V_{IN} = 3.6\text{V}$		-12%	1.7	12%	A
				-12%	1.9	12%	
				-12%	2.5	12%	
				-12%	3.1	12%	
V_{IVM}	Input Voltage Monitor Threshold	V_{IN} Falling	-4%	2.5	4%	V	
f_{SW}	Switching Frequency	$2.5\text{V} \leq V_{IN} \leq 5.5\text{V}$	3.64	4.00	4.36	MHz	
I_Q	Quiescent Supply Current	Device Not Switching Pass Mode, Backlight Disabled		0.6	2	mA	
t_{TX}	Flash to Torch LED Current Settling Time	TX low to High, ILED1,2 = 750 mA to 23.44 mA		4		μs	
High Voltage Boost Specification (Backlight Driver)							
I_{BLED1}, I_{BLED2}	Output Current Regulation (BLED1 or BLED2)	$2.7\text{V} \leq V_{IN} \leq 5.5\text{V}$, Full Scale Current = 19 mA, Brightness Register = 0xFF	-7%	19	7%	mA	
I_{MATCH_HV}	BLED1 to BLED2 Current Matching ⁽³⁾	$2.7\text{V} \leq V_{IN} \leq 5.5\text{V}$, Full Scale Current = 19 mA, Brightness Register = 0xFF		1	2.25	%	
V_{REG_CS}	Regulated Current Sink Headroom Voltage	$I_{LED} = 19\text{mA}$		400		mV	
V_{HR_MIN}	Current Sink Minimum Headroom Voltage	$I_{LED} = 95\%$ of $I_{LED} = 19\text{ mA}$		130			
R_{DSON}	NMOS Switch On Resistance	$I_{SW} = 500\text{ mA}$		230		m Ω	
I_{CL_BOOST}	NMOS Switch Current Limit	$V_{IN} = 3.6\text{V}$	-10%	1	10%	A	
V_{OVP}	Output Over-Voltage Protection	ON Threshold, $2.7\text{V} \leq V_{IN} \leq 5.5\text{V}$, OVP select bits = 11	38.4	40.0	41.4	V	
		Hysteresis		1			
f_{SW}	Switching Frequency	$2.5\text{V} \leq V_{IN} \leq 5.5\text{V}$, Boost Frequency Select Bit = '0'	465	500	535	kHz	
D_{MAX}	Maximum Duty Cycle			94		%	

(1) All voltages are with respect to the potential at the GND pin.

(2) JEDEC ESD tests are applied at the ASIC level. The human body model is a 100 pF capacitor discharged through a 1.5 k Ω resistor into each pin. The machine model is a 200 pF capacitor discharged directly into each pin.

(3) Matching (%) = $100 \times (|I_{LED1} - I_{LED2}|) / (I_{LED1} + I_{LED2})$

ELECTRICAL CHARACTERISTICS ⁽¹⁾ ⁽²⁾ (continued)

Limits in standard typeface are for $T_A = +25^{\circ}\text{C}$. Limits in **boldface** type apply over the full operating ambient temperature range ($-40^{\circ}\text{C} \leq T_A \leq +85^{\circ}\text{C}$). Unless otherwise specified, $V_{IN} = 3.6\text{V}$.

Symbol	Parameter	Test Conditions	Min	Typ	Max	Unit
Logic Input Voltage Specifications (EN, STROBE, TORCH, TX, PWM)						
V_{IL}	Input Logic Low	$2.5\text{V} \leq V_{IN} \leq 5.5\text{V}$	0		0.4	V
V_{IH}	Input Logic High	$2.5\text{V} \leq V_{IN} \leq 5.5\text{V}$	1.2		V_{IN}	
Logic Input Voltage Specifications (SCL, SDA)						
V_{OL}	Output Logic Low (SDA only)	$I_{LOAD} = 3\text{ mA}$			400	mV
V_{IL}	Input Logic Low	$2.5\text{V} \leq V_{IN} \leq 5.5\text{V}$	0		0.4	V
V_{IH}	Input Logic High	$2.5\text{V} \leq V_{IN} \leq 4.2\text{V}$	1.2		V_{IN}	
I²C-Compatible Timing Specifications (SCL, SDA)						
1/t1	SCL (Clock Frequency)					kHz
t2	Data In Setup Time to SCL High		100			ns
t3	Data Out Stable After SCL Low		0			
t4	SDA Low Setup Time to SCL Low (Start)		100			
t5	SDA High Hold Time After SCL High (Stop)		100			

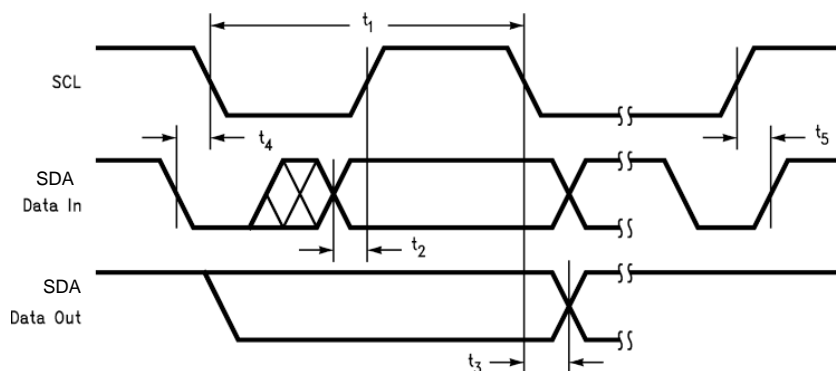

Figure 2. I²C Timing Diagram

TYPICAL PERFORMANCE CHARACTERISTICS

Unless otherwise specified: $T_A = 25^\circ\text{C}$; $V_{IN} = 3.6\text{V}$; $V_{EN} = V_{IN}$; $C_{IN} = 10\ \mu\text{F}$, $C_{OUTF} = 10\ \mu\text{F}$, $C_{OUTB} = 1\ \mu\text{F}$ (50V 0805 case size); $LF = 1\ \mu\text{H}$; $LB = 22\ \mu\text{H}$.

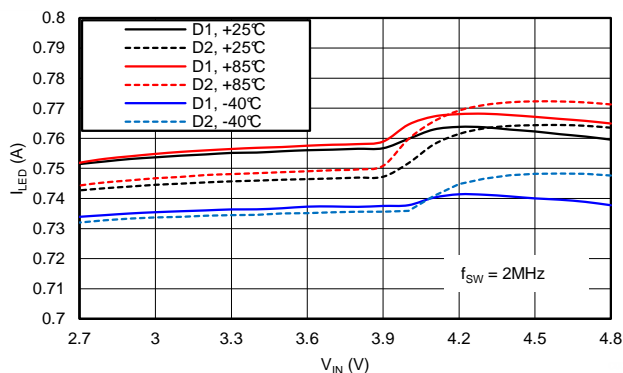

Figure 3. Flash LED Current Line Regulation @ $f_{SW} = 2\text{MHz}$

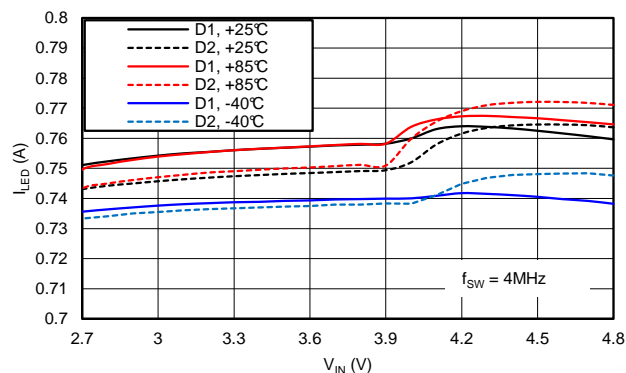

Figure 4. Flash LED Current Line Regulation @ $f_{SW} = 4\text{MHz}$

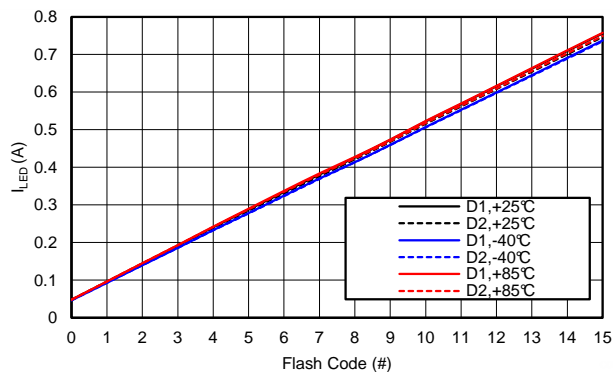

Figure 5. Flash LED Current vs Brightness Code

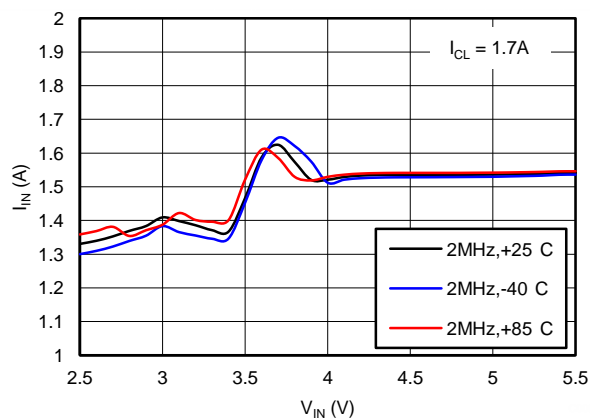

Figure 6. Input Current vs Input Voltage, $I_{FLASH} = 1.5\text{A}$

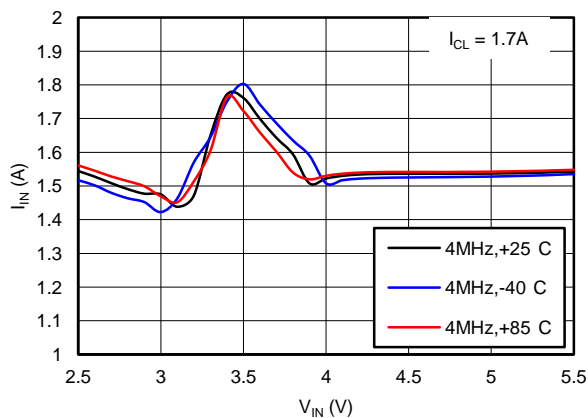

Figure 7. Input Current vs Input Voltage, $I_{FLASH} = 1.5\text{A}$

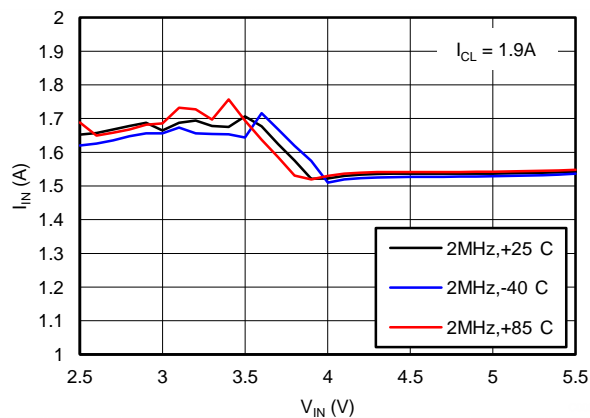

Figure 8. Input Current vs Input Voltage, $I_{FLASH} = 1.5\text{A}$

TYPICAL PERFORMANCE CHARACTERISTICS (continued)

Unless otherwise specified: $T_A = 25^\circ\text{C}$; $V_{IN} = 3.6\text{V}$; $V_{EN} = V_{IN}$; $C_{IN} = 10\ \mu\text{F}$, $C_{OUTF} = 10\ \mu\text{F}$, $C_{OUTB} = 1\ \mu\text{F}$ (50V 0805 case size); $LF = 1\ \mu\text{H}$; $LB = 22\ \mu\text{H}$.

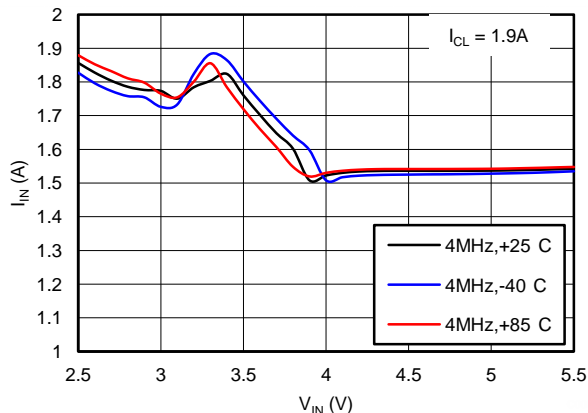

Figure 9. Input Current vs Input Voltage, $I_{FLASH} = 1.5\text{A}$

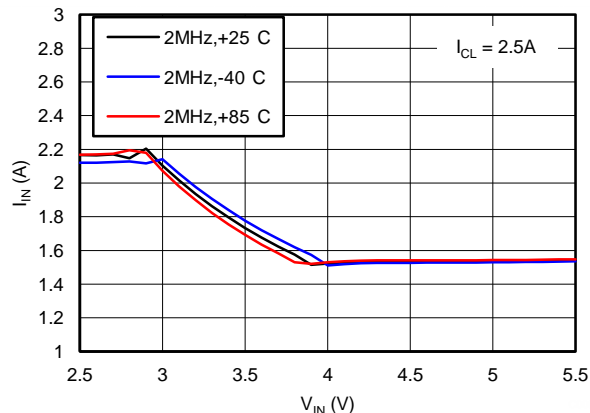

Figure 10. Input Current vs Input Voltage, $I_{FLASH} = 1.5\text{A}$

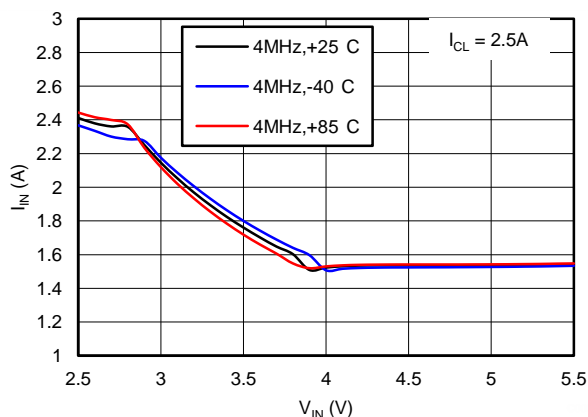

Figure 11. Input Current vs Input Voltage, $I_{FLASH} = 1.5\text{A}$

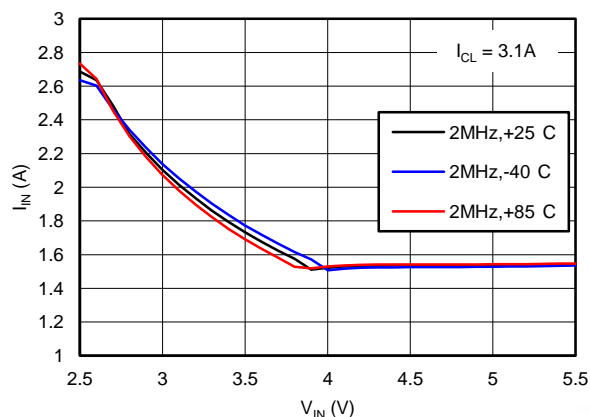

Figure 12. Input Current vs Input Voltage, $I_{FLASH} = 1.5\text{A}$

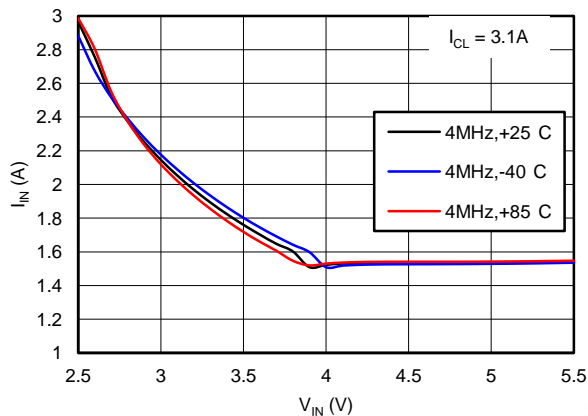

Figure 13. Input Current vs Input Voltage, $I_{FLASH} = 1.5\text{A}$

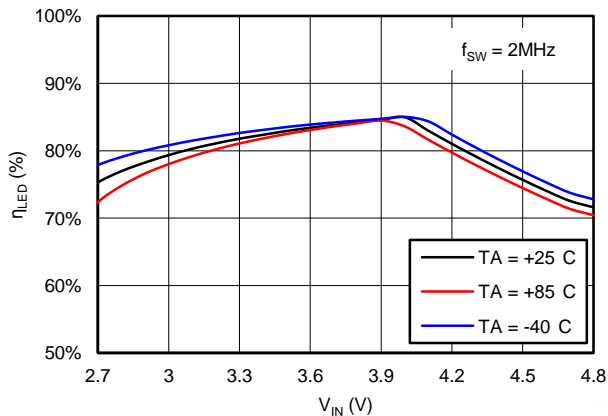

Figure 14. Flash LED Efficiency vs Input Voltage

TYPICAL PERFORMANCE CHARACTERISTICS (continued)

Unless otherwise specified: $T_A = 25^\circ\text{C}$; $V_{IN} = 3.6\text{V}$; $V_{EN} = V_{IN}$; $C_{IN} = 10\ \mu\text{F}$, $C_{OUTF} = 10\ \mu\text{F}$, $C_{OUTB} = 1\ \mu\text{F}$ (50V 0805 case size); $LF = 1\ \mu\text{H}$; $LB = 22\ \mu\text{H}$.

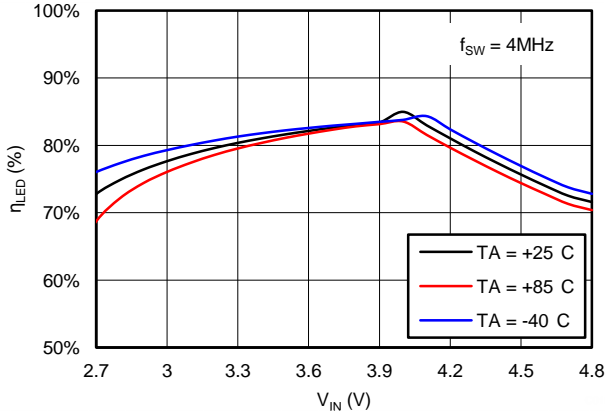

Figure 15. Flash LED Efficiency vs Input Voltage

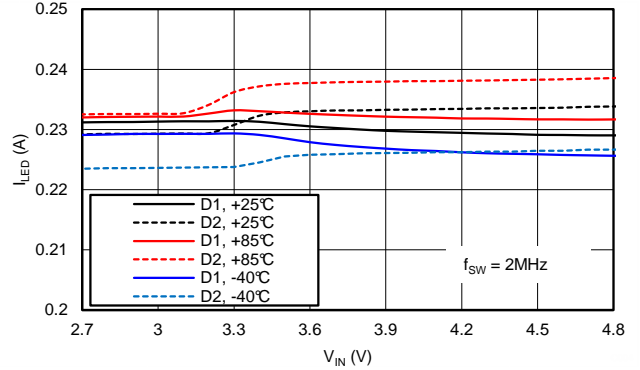

Figure 16. Torch Current Line Regulation

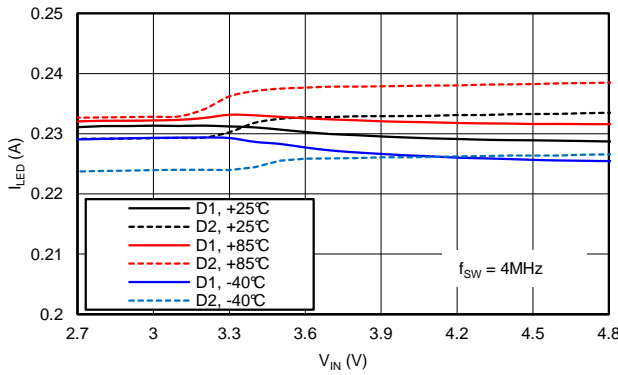

Figure 17. Torch Current Line Regulation

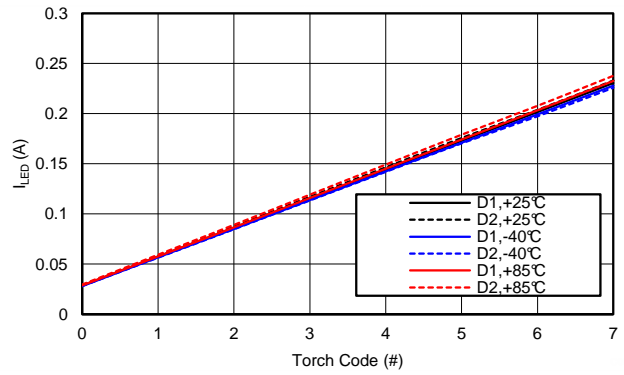

Figure 18. Flash LED Torch Current vs Brightness Code

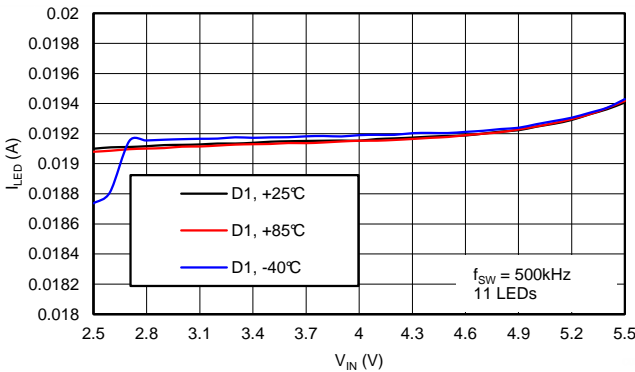

Figure 19. Backlight LED Current Line Regulate Single String

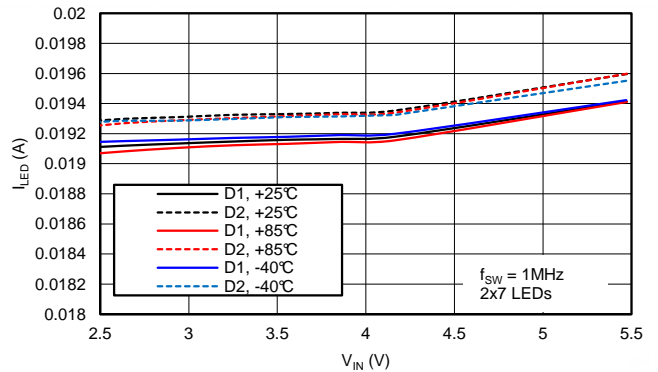

Figure 20. Backlight LED Current Line Regulate Dual String

TYPICAL PERFORMANCE CHARACTERISTICS (continued)

Unless otherwise specified: $T_A = 25^\circ\text{C}$; $V_{IN} = 3.6\text{V}$; $V_{EN} = V_{IN}$; $C_{IN} = 10\ \mu\text{F}$, $C_{OUTF} = 10\ \mu\text{F}$, $C_{OUTB} = 1\ \mu\text{F}$ (50V 0805 case size); $LF = 1\ \mu\text{H}$; $LB = 22\ \mu\text{H}$.

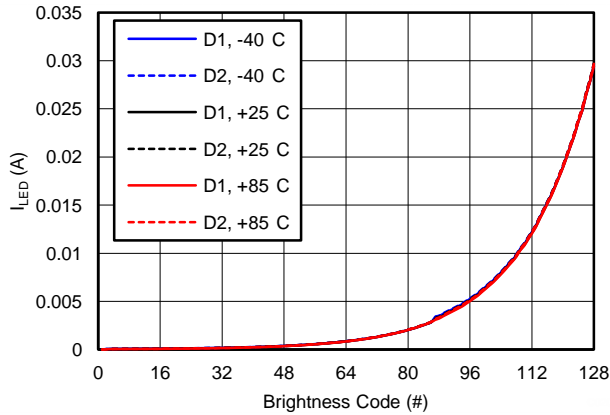

Figure 21. Backlight LED Current vs Brightness Code Exponential

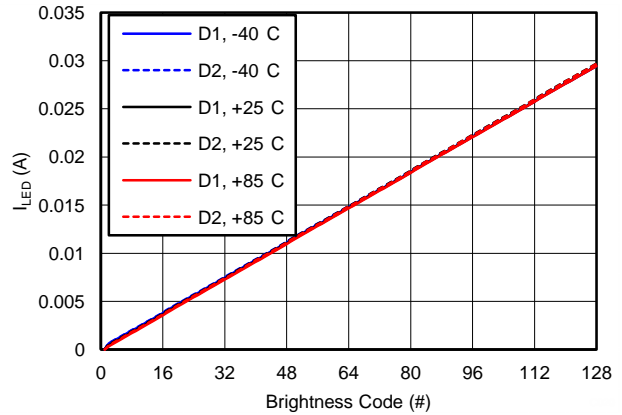

Figure 22. Backlight LED Current vs Brightness Code Linear

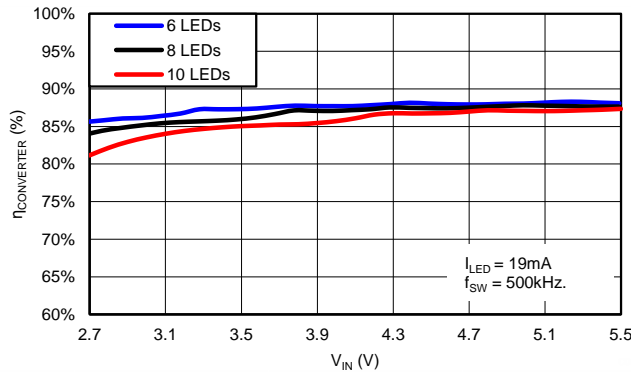

Figure 23. Backlight Efficiency vs Input Voltage Single String

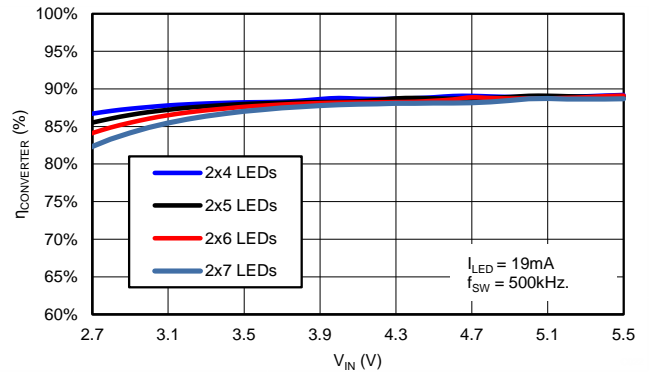

Figure 24. Backlight Efficiency vs Input Voltage Dual String

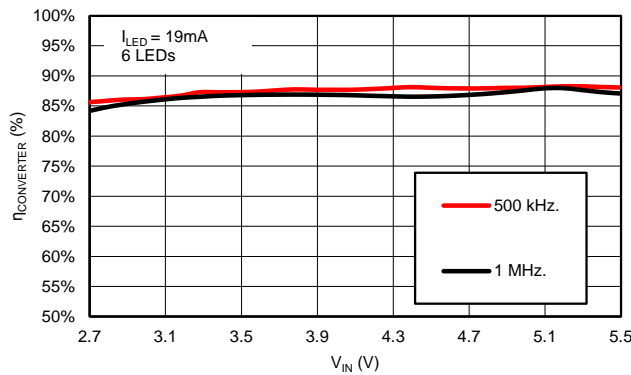

Figure 25. Backlight Efficiency vs Input Voltage Single String - 6 LEDs

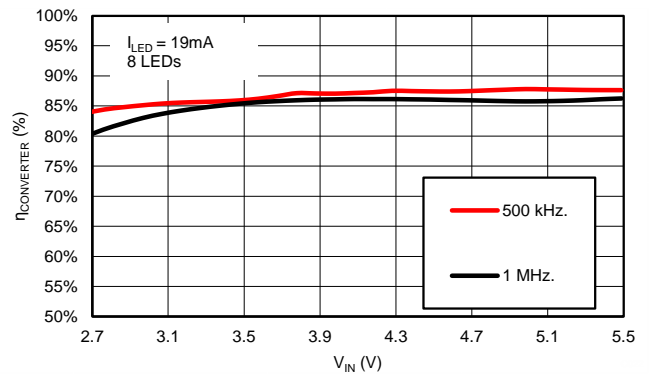

Figure 26. Backlight Efficiency vs Input Voltage Single String - 8 LEDs

TYPICAL PERFORMANCE CHARACTERISTICS (continued)

Unless otherwise specified: $T_A = 25^\circ\text{C}$; $V_{IN} = 3.6\text{V}$; $V_{EN} = V_{IN}$; $C_{IN} = 10\ \mu\text{F}$, $C_{OUTF} = 10\ \mu\text{F}$, $C_{OUTB} = 1\ \mu\text{F}$ (50V 0805 case size); $LF = 1\ \mu\text{H}$; $LB = 22\ \mu\text{H}$.

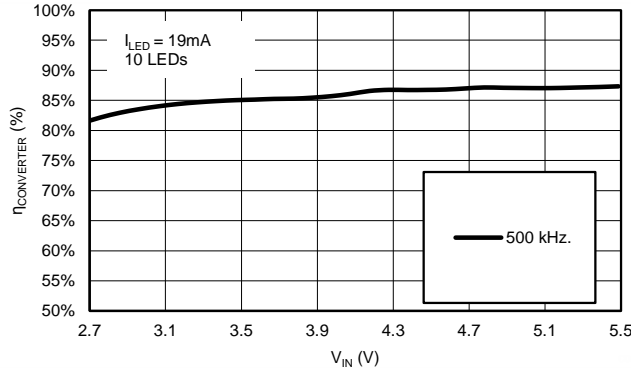

Figure 27. Backlight Efficiency vs Input Voltage Single String - 10 LEDs

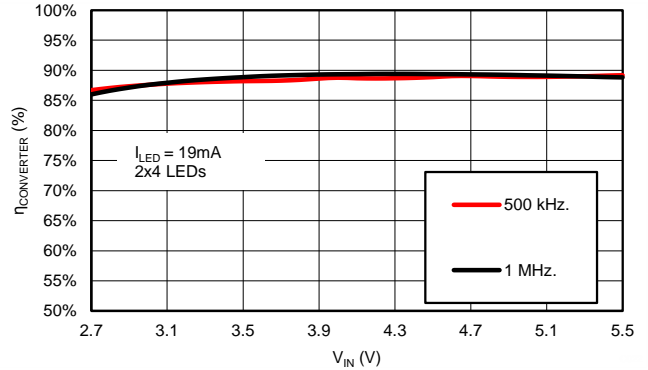

Figure 28. Backlight Efficiency vs Input Voltage Dual String - 2x4 LEDs

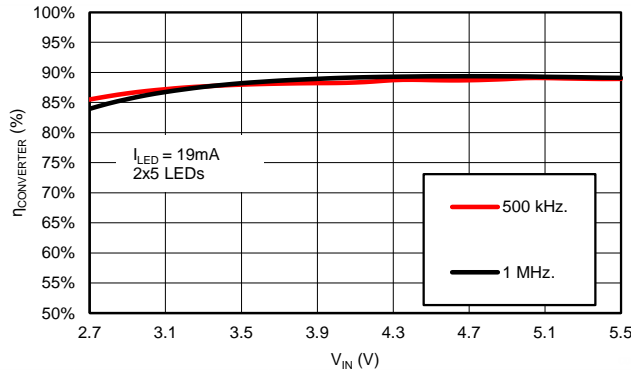

Figure 29. Backlight Efficiency vs Input Voltage Dual String - 2x5 LEDs

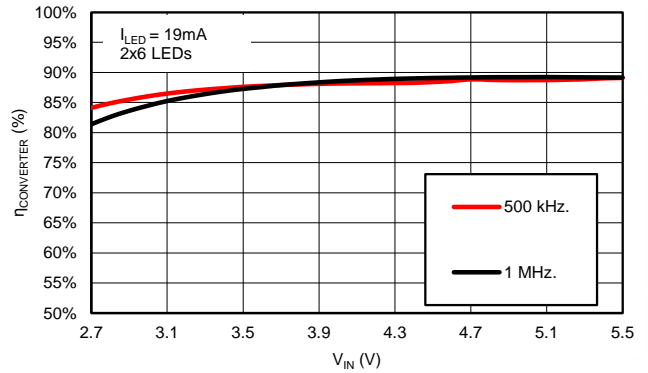

Figure 30. Backlight Efficiency vs Input Voltage Dual String - 2x6 LEDs

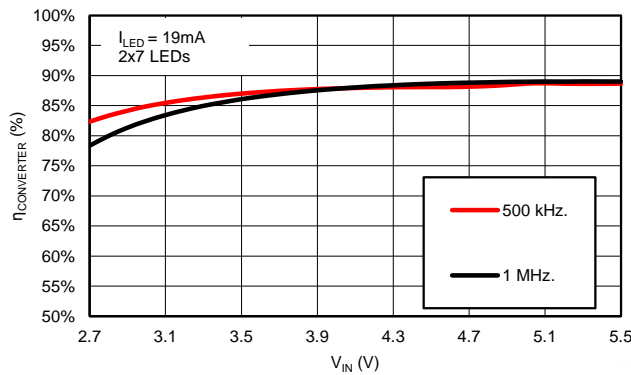

Figure 31. Backlight Efficiency vs Input Voltage Dual String - 2x7 LEDs

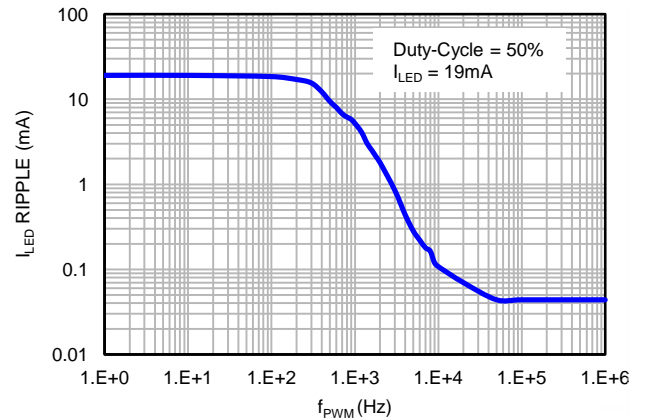

Figure 32. PWM Input Filter Response

TYPICAL PERFORMANCE CHARACTERISTICS (continued)

Unless otherwise specified: $T_A = 25^\circ\text{C}$; $V_{IN} = 3.6\text{V}$; $V_{EN} = V_{IN}$; $C_{IN} = 10\ \mu\text{F}$, $C_{OUTF} = 10\ \mu\text{F}$, $C_{OUTB} = 1\ \mu\text{F}$ (50V 0805 case size); $L_F = 1\ \mu\text{H}$; $L_B = 22\ \mu\text{H}$.

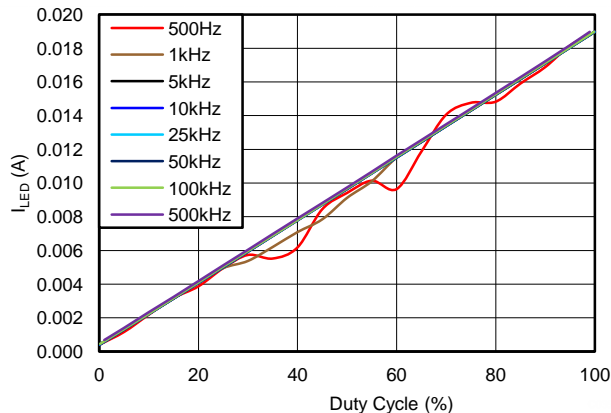

Figure 33. LED Current vs PWM Duty-Cycle

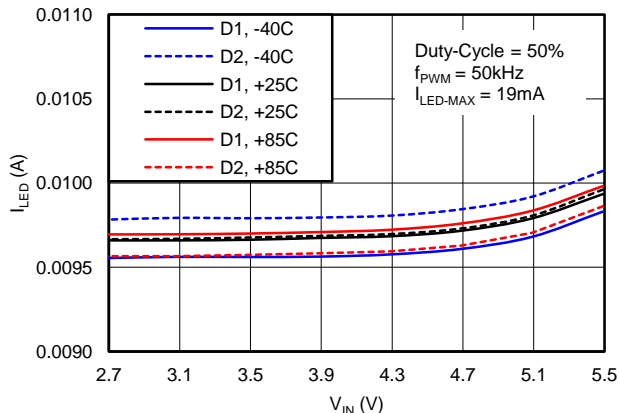

Figure 34. LED Current vs Input Voltage w/ PWM Enabled

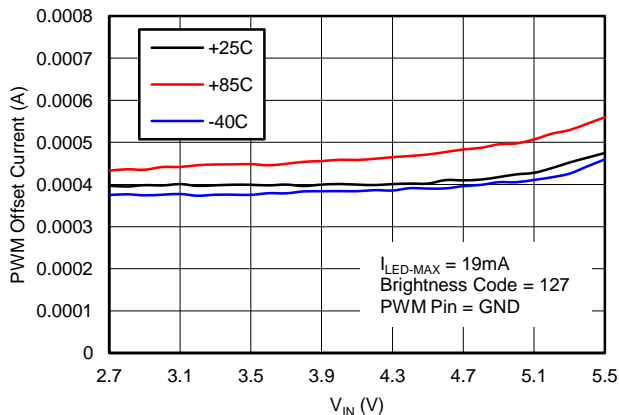

Figure 35. PWM Offset Current vs Input Voltage Tri-Temp

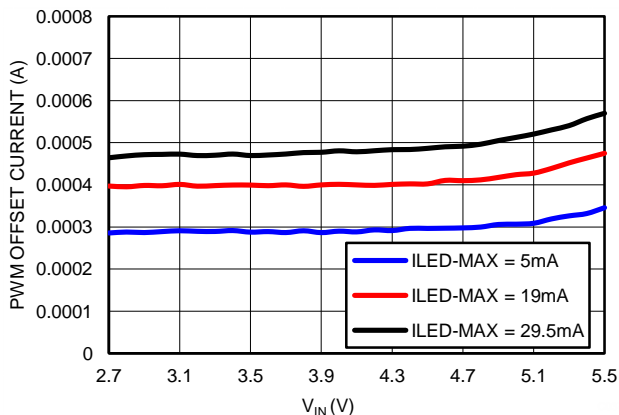

Figure 36. PWM Offset Current vs Input Voltage Different Max. LED Current, Brightness Code = 127

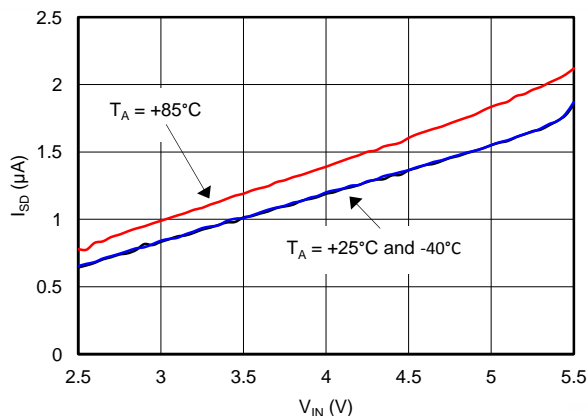

Figure 37. Shutdown Current vs. V_{IN} $EN = 0V$

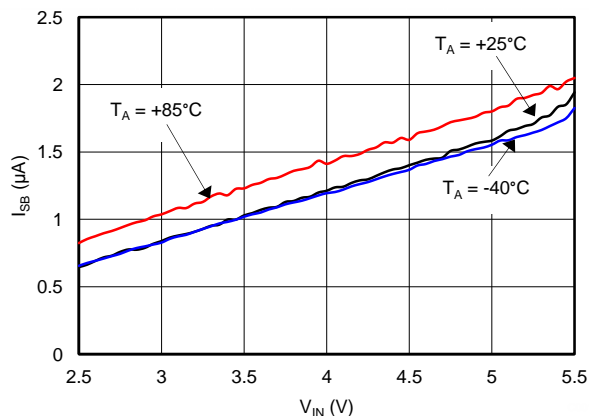

Figure 38. Standby Current vs. V_{IN} $EN = V_{IN}$

TYPICAL PERFORMANCE CHARACTERISTICS (continued)

Unless otherwise specified: $T_A = 25^\circ\text{C}$; $V_{IN} = 3.6\text{V}$; $V_{EN} = V_{IN}$; $C_{IN} = 10\ \mu\text{F}$, $C_{OUTF} = 10\ \mu\text{F}$, $C_{OUTB} = 1\ \mu\text{F}$ (50V 0805 case size); $LF = 1\ \mu\text{H}$; $LB = 22\ \mu\text{H}$.

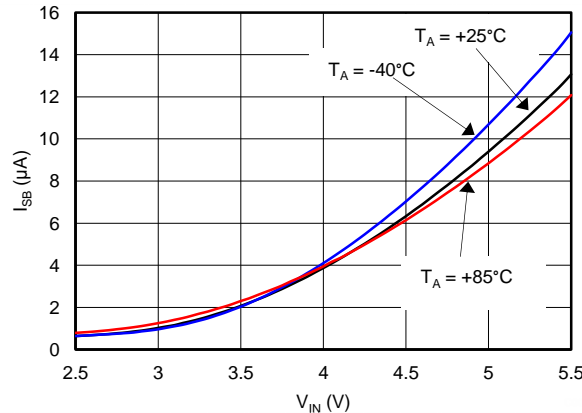

Figure 39. Standby Current vs. V_{IN}
EN = 1.8V

FUNCTIONAL DESCRIPTION

Flash and Backlight Enable (EN)

The LM3639A operates from a 2.5V to 5.5V input voltage (V_{IN}). EN must be pulled high to bring the LM3639A out of shutdown. Once EN is high the flash driver and backlight driver can be enabled via the I²C-compatible interface.

Thermal Shutdown

The LM3639A features a thermal shutdown. When the die temperature reaches 140°C the flash boost, backlight boost, flash LED current sources, and backlight current sinks shut down.

Flash LED Boost Operation

The LM3639A's low-voltage boost provides the power for a single flash LED at up to 1.5A or dual flash LEDs at up to 750 mA each. The device incorporates a 2MHz or 4MHz constant frequency-synchronous boost converter, and two high-side current sources to regulate the LED currents from a 2.5V to 5.5V input voltage range. The boost converter switches and maintains at least V_{HR} across each of the current sources (FLED1 and FLED2). This minimum headroom voltage ensures that the current source remains in regulation. If the input voltage is above the LED voltage + current source headroom voltage, the device does not switch and turns the PFET on continuously (Pass mode). In Pass mode the difference between $(V_{IN} - I_{LED} \times R_{PMOS})$ and the voltage across the LED is dropped across each of the current sources. The LM3639A has a hardware Flash Enable input (STROBE) and a Flash Interrupt input (TX) designed to interrupt the flash pulse during high battery current conditions. Both logic inputs have internal 300 k Ω (typ.) pull-down resistors to GND. Additional features of the LM3639A include an input voltage monitor that can reduce the Flash current (during V_{IN} under voltage conditions). Control of the LM3639A's flash driver is done via the I²C-compatible interface.

Startup (Enabling the FLASH LED Boost)

On startup, when V_{OUT} is less than V_{IN} , the internal synchronous PFET turns on as a current source and delivers 200 mA (typ.) to the output capacitor. During this time the current source (LED) is off. When the voltage across the output capacitor reaches 2.2V (typ.) the current sources will turn on. At turn-on the current sources will step through each FLASH or TORCH level until the target LED current is reached. This gives the device a controlled turn-on and limits inrush current from the V_{IN} supply.

Pass Mode

The LM3639A starts up in Pass Mode and stays there until Boost Mode is needed to maintain regulation. If the voltage difference between VOUT and VLED falls below VHR, the device switches to Boost Mode. In Pass Mode the boost converter does not switch, and the synchronous PFET turns fully on bringing VOUT up to VIN – ILED x RPMOS.

Flash Mode Currents

There are 16 programmable flash current levels for FLED1 and FLED2 from 46.875 mA to 750 mA. Flash mode is activated via the I²C-compatible interface or by pulling the STROBE pin HIGH (LOW if configured as Active-Low). Once the Flash sequence is activated the current sources will ramp up to their programmed Flash current by stepping through all current steps until the programmed current is reached.

Table 1. Flash Current vs. Code

Code 0000 = 46.875 mA
Code 0001 = 93.75 mA
Code 0010 = 140.625 mA
Code 0011 = 187.5 mA
Code 0100 = 234.375 mA
Code 0101 = 281.25 mA
Code 0110 = 328.125 mA
Code 0111 = 375 mA
Code 1000 = 421.875 mA
Code 1001 = 468.75 mA
Code 1010 = 515.625 mA
Code 1011 = 562.5 mA
Code 1100 = 609.375 mA
Code 1101 = 656.25 mA
Code 1110 = 703.125 mA
Code 1111 = 750 mA

Torch Mode

Torch mode is activated through the I²C-compatible interface setting or by the hardware STROBE input when the Strobe EN bit is set to '1'. Once Torch mode is enabled the current sources will ramp up to the programmed Torch current level.

Table 2. Torch Current vs. Code

Code 000 = 28.125 mA
Code 001 = 56.25 mA
Code 010 = 84.375 mA
Code 011 = 112.5 mA
Code 100 = 140.625 mA
Code 101 = 168.75 mA
Code 110 = 196.875 mA
Code 111 = 225 mA

Independent LED Control

The part has the ability to independently turn on and turn off the FLED1 or FLED2 current sources. The LED current is adjusted by writing to the Torch Brightness or Flash Brightness Registers. Both the FLED1 or FLED2 use the same target current level stored in the Torch Brightness and the Flash Brightness Registers. Both LED outputs use the same LED ramp step time.

Power Amplifier Synchronization (TX)

The TX pin is a Power Amplifier Synchronization input. This is designed to reduce the flash LED currents and thus limit the battery-current during high battery current conditions such as PA transmit events. When the LM3639A is engaged in a Flash event and the TX pin is pulled high, the LED current is forced into Torch mode at the programmed Torch current setting. If the TX pin is then pulled low before the Flash pulse terminates, the LED current will return to the previous Flash current level. At the end of the Flash time-out, whether the TX pin is high or low, the LED current will turn off. The TX pin has a 300 k Ω pull-down resistor connected to GND.

Input Voltage Flash Monitor (IVFM)

The LM3639A has the ability to adjust the flash current based upon the voltage level present at the VIN pin utilizing an Input Voltage Flash Monitor. The adjustable VIN Monitor threshold ranges from 2.5V to 3.2V in 100 mV steps. Depending on the option, the LM3639A will either transition the LED current to the programmed Torch current or shut down completely when the Input Voltage Monitor detects an input voltage drop lower than the threshold value.

Flash LED Fault/Protections

Flash Timeout

The Flash Timeout period sets the maximum amount of time that the Flash Currents is sourced from each of the current source (FLED1 and FLED2). The LM3639A has 32 timeout levels ranging 32 ms to 1024 ms in 32 ms steps. Flash Timeout only applies to the Flash Mode operation. In I²C-compatible Flash Mode, the flash period is equal to the timeout value. In Strobe Flash Mode, the flash period is set by the active duration of the Strobe pin if the duration is less than the timeout value. If the Strobe event lasts longer than the set flash timeout value, the flash event will terminate upon reach the timeout period.

Over-Voltage Protection (OVP)

The output voltage is limited to typically 5.0V (see V_{OVP} Spec). In situations such as an open LED, the LM3639A will raise the output voltage in order keep the LED current at its target value. When V_{OUTF} reaches 5.0V (typ.) the over-voltage protection (OVP) comparator will trip and turn off the internal NFET. When V_{OUTF} falls below the " V_{OVP} Off Threshold", the LM3639A will begin switching again. The mode bits in the Enable Register (0x0A) are not cleared upon an OVP event.

Current Limit

The LM3639A features selectable inductor current limits. When the inductor current limit is reached, the LM3639A will terminate the charging phase of the switching cycle. Since the current limit is sensed in the NMOS switch, there is no mechanism to limit the current when the device operates in Pass Mode. In Boost mode or Pass mode, if OUTF falls below 2.3V, the part stops switching, and the PFET operates as a current source limiting the current to 200 mA. This prevents damage to the LM3639A and excessive current draw from the battery during output short-circuit conditions. **Pulling additional current from the OUTF node during normal operation is not recommended.**

LED and/or OUTF Fault

The LM3639A determines an LED open condition if the OVP threshold is crossed at the OUTF pin while the device is in Flash or Torch mode. An LED short condition is determined if the voltage at LED goes below 500 mV (typ.) while the device is in Torch or Flash mode. There is a delay of 256 μ s deglitch time before the LED flag is valid and 2.048 ms before the VOUT flag is valid. This delay is the time between when the Flash or Torch current is triggered and when the LED voltage and the output voltage are sampled.

Backlight Boost Operation

The high-voltage boost converter provides power for the two current sinks (BLED1 and BLED2). The backlight boost operates using a 10 μ H to 22 μ H inductor and a 1 μ F output capacitor. The selectable 500 kHz or 1 MHz switching frequency allows use of small external components and provides for high boost converter efficiency. When there are different voltage requirements in both high-voltage LED strings, the LM3639A's backlight boost will regulate the feedback point of the highest voltage string to 400 mV and drop the excess voltage of the lower voltage string across its current sink.

Backlight Over-Voltage Protection

The output voltage protection is limited to typically 16V, 24V, 32V or 40V (see VOVP Spec). In situations such as an open LED, the LM3639A will raise the output voltage in order to keep the LED current at its target value. When VOUTB reaches the selected OVP level, the over-voltage comparator will trip and turn off the internal NFET. When VOUT falls below the “VOVP Off Threshold”, the LM3639A will begin switching again. By default, the Backlight OVP flag in the Flag Register (0x0B, Bit7) will not be set upon hitting an OVP condition. To enable this reporting feature, the BL Flag Report bit (Register 0x09, Bit7) must be set to a '1'. The BL Flag Report function is intended for use in a factory environment to check for LED connectivity and is not intended for use during normal operation.

Backlight LED Short Detection

The LM3639A features a Backlight LED short flag that indicates whether either of the BLEDx pins rise above (VIN - 1V). This detection block can help detect whether one or more of the LEDs in a string have experienced a short when operating in a balanced dual-string LED configuration (ex: 2 strings of 5 is balanced. One string of 5 and one string of 4 is unbalanced). If one or more of the LEDs in a string become shorted, and either of the BLEDx pins rise above (VIN - 1V), the BLED1/2 Flag in the Flag register (0x0B, Bit2) will be set to a '1'. By default this detection block is disabled. To enable this reporting feature, the BL Flag Report bit (Register 0x09, Bit7) must be set to a '1'. The BL Flag Report function is intended for use in a factory environment to check for LED connectivity and is not intended for use during normal operation.

Backlight Current Sinks (B_{LED1} and B_{LED2})

BLED1 and BLED2 control the current in the backlight boost LED strings. Each current sink has 3-bit full-scale current programmability and 7-bit brightness control. Either current sink can have its current set through a dedicated brightness register and be controlled via the PWM input.

Backlight Boost Switching Frequency

The LM3639A's backlight boost converter can have a 500 kHz or 1 MHz switching frequency. For the 500 kHz switching frequency selection the inductor must be 22 μH. For the 1 MHz switching frequency selection the inductor can be 10 μH or 22 μH.

PWM Input

There is a single PWM input which can control the current in the backlight current sinks (BLED1/2). When the PWM input is enabled, the current becomes a function of the full-scale current, the brightness code, and the PWM input duty cycle. The PWM pin has a 300 kΩ pull-down resistor connected to GND.

PWM Polarity

The PWM input can be programmed to have active high or active low polarity.

Full-Scale Current

There are 8 (3-bit) separate full-scale current settings for the backlight current. The full-scale current is the maximum backlight current when the brightness code is at 100% (Code 0x7F). The full-scale current vs full-scale current code is given by:

$$I_{LED \text{ Fullscale}} = 5\text{mA} + (\text{CODE} \times 3.5 \text{ mA}) \quad (1)$$

Table 3. Full-Scale Current vs. Code

Code	Full Scale Current
000	5 mA
001	8.5 mA
:	:
100	19 mA
:	:
110	26 mA
111	29.5 mA

LED Current Mapping Modes

The backlight current can be programmed for either exponential or linear mapping modes. These modes determine the transfer characteristic of backlight code to LED current. The brightness code selected for linear will always be forced to be equal to the exponential value. The brightness code for exponential will always be mapped to the linear code as well.

Exponential Mapping

In exponential mapping mode the brightness code to backlight current transfer function is given by the equation:

$$I_{LED} = I_{LED_FULLSCALE} \times D_{PWM} \times 0.85^{\left[44 - \left(\frac{Code+1}{2.91}\right)\right]} \quad (2)$$

where $I_{LED_FULLSCALE}$ is the full-scale LED current setting, Code is the backlight code in the brightness register, and D_{PWM} is the PWM input duty cycle. In exponential mapping mode the current ramp (either up or down) appears to the human eye as a more uniform transition than the linear ramp. This is due to the logarithmic response of the eye. **NOTE: Code '0' does not enable the boost or the current sinks and should not be used.**

Linear Mapping

In linear mapping mode the brightness code to backlight current has a linear relationship and follows the equation:

$$I_{LED} = I_{LED_FULLSCALE} \times \frac{1}{127} \times Code \times D_{PWM} \quad (3)$$

where $I_{LED_FULLSCALE}$ is the full-scale LED current setting, Code is the backlight code in the brightness register, and D_{PWM} is the PWM input duty cycle. **NOTE: Code '0' does not enable the boost or the current sinks and should not be used.**

LED Current Ramping

Ramp-Up/Ramp-Down Step Time

The Ramp-Up step time is the time the LM3639A spends at each current step during the ramping up of the backlight LED current. The Ramp-Down step time is the time the LM3639A spends at each current step during the ramping down of the backlight LED current. There are 8 different Ramp-Up and 8 different Ramp-Down step times. The Ramp-Up and Ramp-Down step times are independently programmable, but not independently programmable for each backlight current sink. For example, programming a Ramp-Up or Ramp-Down time programs the same ramp time for the current in both BLED1 and BLED2.

Table 4. Ramp Times

Code	Ramp-Up Step Time	Ramp-Down Step Time
000	32 μ s	32 μ s
001	4.096 ms	4.096 ms
010	8.192 ms	8.192 ms
011	16.384 ms	16.384 ms
100	32.768 ms	32.768 ms
101	65.536 ms	65.536 ms
110	131.072 ms	131.072 ms
111	262.144 ms	262.144 ms

APPLICATION INFORMATION

Register Map (7-Bit I²C Chip Address = 0x39)

0x00	[7:0]	Device ID	0x00 0001 0001
0x01	[7:0]	Check sum	0x01 0000 1001
BACKLIGHT CONFIGURATION REGISTERS			
0x02	[7]	N/A	
	[6:5]	BLED OVP	00 = 16V
			01 = 24V (default)
			10 = 32V
			11 = 40V
	[4]	BLED Mapping mode	0 = Exponential 1 = Linear (default)
	[3]	BLED PWM configuration	0 = Active high (default) 1 = Active low
[2:0]	BLED Max Current	000 - 5 mA	
		100 19 mA Default	
		111 - 29.5 mA	
0x03	[7]	RFU	Must ALWAYS be set to a '0'
	[6]	BLED SW Frequency	0 = 500 kHz (default)
			1 = 1 Mhz
	[5:3]	BLED Brightness Ramp Fall Rate	000 = 32 μ s per step ~ 111 = 262 ms per step
[2:0]	BLED Brightness Ramp rise Rate	000 = 32 μ s per step ~ 111 = 262 ms per step	
0x04	[7]	N/A	-
	[6:0]	BLED Brightness control	128 step (7-bit) (Exponential)
0x05	[7]	N/A	-
	[6:0]	BLED Brightness control	128 step (7-bit) (Linear)
Any code written to Register 0x04 will be mapped to 0x05. Any code written to Register 0x05 will be mapped to 0x04 Writing a '0' to either Register 0x04 or 0x05 is not recommended as the LM3639A will remain off.			
FLASH CONFIGURATION REGISTERS			
0x06	7	N/A	
	[7:4]	FLED LED1/2 Torch current	000 = 28.125 mA
			~
			111 = 225 mA
	[3:0]	FLED LED1/2 strobe Current	0000 = 46.875 mA
~			
1111 = 750 mA			

0x07	[7]	FLED SW Frequency	0 = 2 MHz (default) 1 = 4 MHz			
	[6:5]	FLED Current Limit	00 = 1.7A 01 = 1.9A 10 = 2.5A (default) 11 = 3.1A			
			[4:0]	FLED Strobe Time-Out	00000 = 32 ms 01111 = 512 ms (default) 11111 = 1024 ms	
					[7:3]	N/A
					[2:0]	FLED V _{IN} monitor
	I/O CONTROL REGISTER					
0x09	[7]	Backlight Flag Reporting	1 = Backlight OVP and BLED1/2 Short Flag Reporting ACTIVE 0 = Backlight OVP and BLED1/2 Short Flag Reporting DISABLED (default)			
	[6]	PWM ENABLE	1 = PWM Enabled 0 = PWM Ignored			
	[5]	STROBE POLARITY	1 = Active High 0 = Active Low			
	[4]	STROBE EN	1 = Strobe Flash 0 = I ² C Flash			
	[3]	TX POLARITY	1 = Active High 0 = Active Low			
	[2]	TX Enable	1 = Tx Enabled 0 = Tx Ignored			
	[1]	VIN Monitor Mode	1 = Standby 0 = Torch			
	[0]	VIN Monitor EN	1 = VIN Monitor Enabled 0 = Disabled			
ENABLE REGISTER						
0x0A	[7]	Software Reset	1 = RESET 0 = disable (auto)			
			[6]	FLED1 EN	1 = Flash LED1 On 0 = Disabled	
	[5]	FLED2 EN			1 = Flash LED2 On 0 = Disabled	
			[4]	BLED1 EN	1 = Backlight LED1 On 0 = Disabled	
	[3]	BLED2 EN			1 = Backlight LED2 On 0 = Disabled	
			[2]	Torch/Flash	1 = FLASH 0 = TORCH	
	[1]	FLASH EN			1 = Enable FLASH 0 = Off	
			[0]	BACKLIGHT EN	1 = Enable Backlight 0 = Off	

Setting both "FLED1 EN" and "FLED2 EN" to '0' when "FLASH EN" is '1' is not recommended as the flash boost will run in OVP
 Setting both "BLED1 EN" and "BLED2 EN" to '0' when "BACKLIGHT EN" is '1' is not recommended backlight boost will run in OVP.
 See [Notes](#) for more configuration details.

FLAGS REGISTER			
0x0B	[7]	BACKLIGHT OVP	1 = FAULT
			0 = NORMAL
	[6]	FLASH OVP	1 = FAULT
			0 = NORMAL
	[5]	FLASH OUTPUT SHORT	1 = FAULT
			0 = NORMAL
	[4]	VIN MONITOR	1 = VIN Monitor Threshold Crossed
			0 = Normal
	[3]	TX INTERRUPT	1 = TX Event Occurred
			0 = Normal
	[2]	FLED1/2 SHORT	1 = FAULT
			0 = NORMAL
	[1]	BLED1/2 SHORT	1 = FAULT
			0 = NORMAL
	[0]	THERMAL SHUTDOWN	1 = Thermal Shutdown
			0 = Normal

Notes

- To initiate a flash event, the Flash EN bit must be set via I²C (Reg 0x0A, bit 1 = '1'). Upon the termination of a flash event (I²C Controlled or Strobe Controlled), the Flash EN bit in register 0x0A will automatically clear itself to '0'. To restart a flash event, the Flash EN bit must be reset to a '1' via an I²C write.
- During Backlight Operation, registers 0x02 and 0x03 become READ-ONLY. To adjust the values of registers 0x02 and 0x03, the Backlight EN bit in register 0x0A must be set to a '0' first.
- During Flash Operation, register 0x07 becomes READ-ONLY. To adjust the values of register 0x07, the Flash EN bit in register 0x0A must be set to a '0' first.
- If a single Backlight string is used, the string must be connected to BLED1, and the BLED2 EN bit must be set to '0'. BLED2 in this configuration should be left floating.
- If a single Flash LED is going to be used without shorting FLED1 to FLED2, FLED1 must be used and the FLED2 EN bit must be set to a '0'. FLED2 in this configuration should be left floating.

Applications Information: Backlight

Backlight Inductor Selection

The LM3639A is designed to work with a 10 µH to 22 µH inductor. When selecting the inductor, ensure that the saturation rating is high enough to accommodate the applications peak inductor current. The inductance value must also be large enough so that the peak inductor current is kept below the LM3639A's switch current limit. [Table 5](#) lists various inductors that can be used with the LM3639A. The inductors with higher saturation currents are more suitable for applications with higher output currents or voltages (multiple strings). The smaller devices are geared toward single string applications with lower series LED counts.

NOTE

For high LED count single string applications (greater than 9 LEDs), the 500 kHz switching frequency and a 22 µH inductor must be used. For dual string applications with a maximum LED count of two strings of 7 LEDs, a 22 µH inductor is required for use with the 500kHz switching frequency, whereas a 10 µH or a 22 µH inductor can be used with the 1 MHz switching frequency.

Table 5. Inductors

Manufacturer	Part Number	Value	Size	Current Rating	DC Resistance
TDK	VLF403212MT-220M	22 μ H	4 mm \times 3.2 mm \times 1.2 mm	600 mA	0.59 Ω
TDK	VLS252010T-100M	10 μ H	2.5 mm \times 2 mm \times 1 mm	590 mA	0.712 Ω
TDK	VLS2012ET-100M	10 μ H	2 mm \times 2 mm \times 1.2 mm	695 mA	0.47 Ω
TDK	VLF301512MT-100M	10 μ H	3.0 mm \times 2.5 mm \times 1.2mm	690 mA	0.25 Ω
TDK	VLF4010ST-100MR80	10 μ H	2.8 mm \times 3 mm \times 1 mm	800 mA	0.25 Ω
TDK	VLS252012T-100M	10 μ H	2.5 mm \times 2 mm \times 1.2mm	810 mA	0.63 Ω
TDK	VLF3014ST-100MR82	10 μ H	2.8 mm \times 3 mm \times 1.4mm	820 mA	0.25 Ω
TDK	VLF4014ST-100M1R0	10 μ H	3.8 mm \times 3.6 mm \times 1.4 mm	1000 mA	0.22 Ω
Coilcraft	XPL2010-103ML	10 μ H	1.9 mm \times 2 mm \times 1 mm	610 mA	0.56 Ω
Coilcraft	LPS3010-103ML	10 μ H	2.95 mm \times 2.95 mm \times 0.9 mm	550 mA	0.54 Ω
Coilcraft	LPS4012-103ML	10 μ H	3.9mm \times 3.9mm \times 1.1mm	1000 mA	0.35 Ω
Coilcraft	LPS4012-223ML	22 μ H	3.9 mm \times 3.9 mm \times 1.1 mm	780 mA	0.6 Ω
Coilcraft	LPS4018-103ML	10 μ H	3.9 mm \times 3.9 mm \times 1.7 mm	1100 mA	0.2 Ω
Coilcraft	LPS4018-223ML	22 μ H	3.9 mm \times 3.9 mm \times 1.7 mm	700 mA	0.36 Ω

Backlight Output Capacitor Selection

The LM3639A's output capacitor has two functions: to filter the boost converter's switching ripple, and to ensure feedback loop stability. As a filter, the output capacitor supplies the LED current during the boost converter's on time and absorbs the inductor's energy during the switch's off time. This causes a sag in the output voltage during the on time and a rise in the output voltage during the off time. Because of this, the output capacitor must be sized large enough to filter the inductor current ripple that could cause the output voltage ripple to become excessive. As a feedback loop component, the output capacitor must be at least 1 μ F and have low ESR; otherwise, the LM3639A's boost converter can become unstable. This requires the use of ceramic output capacitors. [Table 6](#) lists part numbers and voltage ratings for different output capacitors that can be used with the LM3639A.

NOTE

For all LED applications, it is required that at least 0.4 μ F of capacitance is present at the output of the backlight boost converter. Please refer to the output capacitor data sheets to find the effective capacitance (taking into account the DC Bias effect) of the capacitors at the target application output voltage.

Table 6. Output Capacitors

Manufacturer	Part Number	Value	Size	Rating	Description
TDK	CGA4J3X7R1H105K	1 μ F	0805	50V	COUT
Murata	GRM21BR71H105KA12	1 μ F	0805	50V	COUT

Backlight Diode Selection

The diode connected between SW and OUT must be a Schottky diode and have a reverse breakdown voltage high enough to handle the maximum output voltage in the application. Table 7 lists various diodes that can be used with the LM3639A.

Table 7. Diodes

Manufacturer	Part Number	Value	Size	Rating
Diodes Inc.	B0540WS	Schottky	SOD-323	40V/500 mA
Diodes Inc.	SDM20U40	Schottky	SOD-523 (1.2 mm x 0.8 mm x 0.6 mm)	40V/200 mA
On Semiconductor	NSR0340V2T1G	Schottky	SOD-523 (1.2 mm x 0.8 mm x 0.6 mm)	40V/250 mA
On Semiconductor	NSR0240V2T1G	Schottky	SOD-523 (1.2 mm x 0.8 mm x 0.6 mm)	40V/250 mA

Backlight Layout Guidelines

The LM3639A contains an inductive boost converter which sees a high switched voltage (up to 40V) at the SWB pin, and a step current (up to 1A) through the Schottky diode and output capacitor each switching cycle. The high switching voltage can create interference into nearby nodes due to electric field coupling ($I = CdV/dt$). The large step current through the diode and the output capacitor can cause a large voltage spike at the SW pin and the OVP pin due to parasitic inductance in the step current conducting path ($V = LdI/dt$). Board layout guidelines are geared towards minimizing this electric field coupling and conducted noise. Figure 40 highlights these two noise generating components.

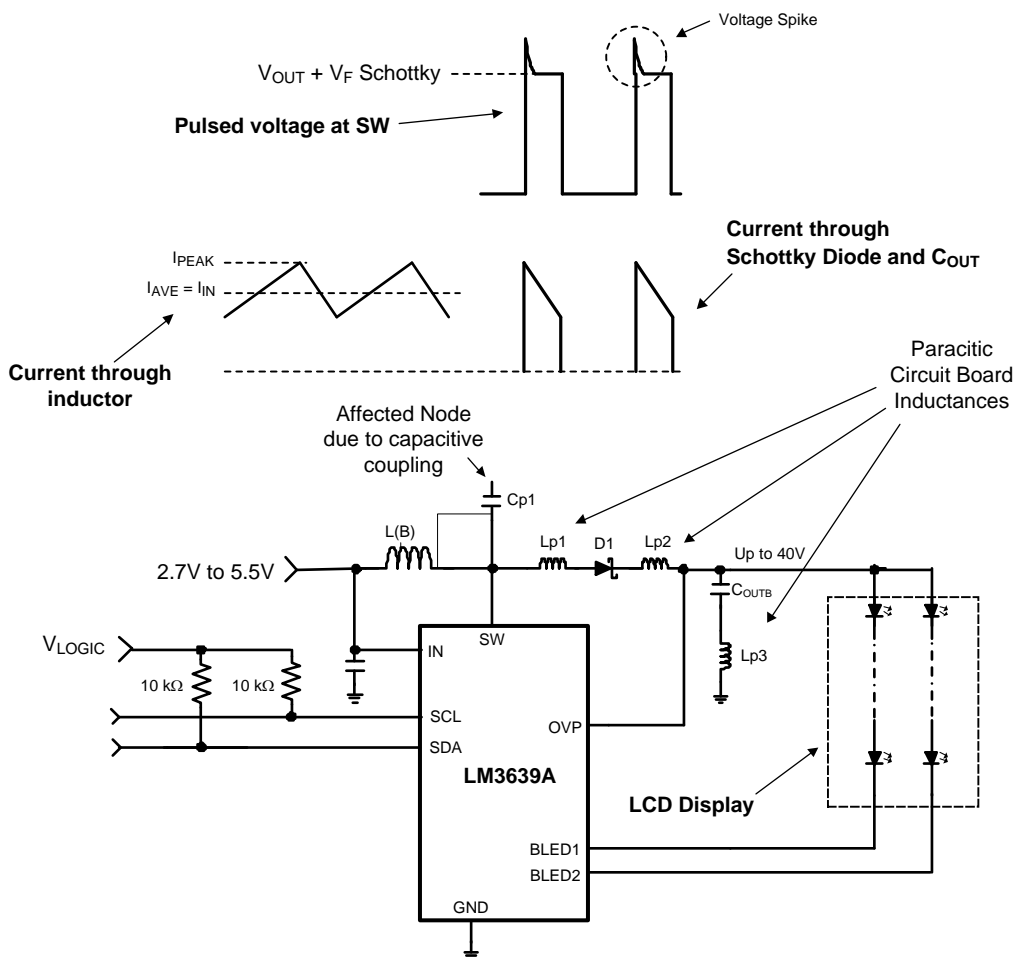

Figure 40. LM3639A's Boost Converter Showing Pulsed Voltage at SW (High dV/dt) and Current Through Schottky and C_{OUT} (High dI/dt)

The following lists the main (layout sensitive) areas of the LM3639A in order of decreasing importance:

- Output Capacitor
- Schottky Cathode to COUTB+
- COUTB- to GND
- Schottky Diode
- SWB Pin to Schottky Anode
- Schottky Cathode to COUTB+
- Inductor
- SWB Node PCB capacitance to other traces
- Input Capacitor
- CIN+ to VIN pin
- CIN- to GND

Backlight Output Capacitor Placement

The output capacitor is in the path of the inductor current discharge current. As a result, C_{OUTB} sees a high current step from 0 to I_{PEAK} each time the switch turns off and the Schottky diode turns on. Typical turn-off/turn-on times are around 5 ns. Any inductance along this series path from the cathode of the diode through C_{OUTB} and back into the LM3639A's GND pin will contribute to voltage spikes ($V_{SPIKE} = L_{PX} \times di/dt$) at SWB and OUTB which can potentially over-voltage the SWB pin, or feed through to GND. To avoid this, C_{OUTB+} must be connected as close as possible to the cathode of the Schottky diode, and C_{OUT-} must be connected as close as possible to the LM3639A's GND bump. The best placement for C_{OUTB} is on the same layer as the LM3639A to avoid any vias that will add extra series inductance.

Schottky Diode Placement

The Schottky diode is in the path of the inductor current discharge. As a result the Schottky diode sees a high current step from 0 to I_{PEAK} each time the switch turns off and the diode turns on. Any inductance in series with the diode will cause a voltage spike ($V_{SPIKE} = L_{PX} \times di/dt$) at SW and OUT which can potentially over-voltage the SW pin, or feed through to VOUT and through the output capacitor and into GND. Connecting the anode of the diode as close as possible to the SW pin and the cathode of the diode as close as possible to COUT+ will reduce the inductance (L_{PX}) and minimize these voltage spikes.

Backlight Inductor Placement

The node where the inductor connects to the LM3639A's SW bump presents two challenges. First, a large switched voltage (0 to $V_{OUT} + V_{F_SCHOTTKY}$) appears on this node every switching cycle. This switched voltage can be capacitively coupled into nearby nodes. Second, there is a relatively large current (input current) on the traces connecting the input supply to the inductor and connecting the inductor to the SW bump. Any resistance in this path can cause large voltage drops that will negatively affect efficiency.

To reduce the capacitively coupled signal from SWB into nearby traces, the SW bump-to-inductor connection must be minimized in area. This limits the PCB capacitance from SW to other traces. Additionally, other nodes need to be routed away from SWB and not directly beneath. This is especially true for high-impedance nodes that are more susceptible to capacitive coupling such as (SCL, SDA, EN, PWM). A GND plane placed directly below SWB will help isolate SWB and dramatically reduce the capacitance from SW into nearby traces.

To limit the trace resistance of the VBATT-to-inductor connection and from the inductor-to-SW connection, use short, wide traces.

Input Capacitor Selection and Placement

The input bypass capacitor filters the inductor current ripple, and the internal MOSFET driver currents, during turn-on of the power switch.

The driver current requirement can be a few hundred mAs with 5 ns rise and fall times. This will appear as high di/dt current pulses coming from the input capacitor each time the switch turns on. Close placement of the input capacitor to the IN pin and to the GND pin is critical since any series inductance between VIN and C_{IN+} or C_{IN-} and GND can create voltage spikes that could appear on the V_{IN} supply line and in the GND plane.

Close placement of the input bypass capacitor at the input side of the inductor is also critical. The source impedance (inductance and resistance) from the input supply, along with the input capacitor of the LM3639A, form a series RLC circuit. If the output resistance from the source (R_S) is low enough the circuit will be underdamped and will have a resonant frequency (typically the case). Depending on the size of L_S the resonant frequency could occur below, close to, or above the LM3639A's switching frequency. This can cause the supply current ripple to be:

- approximately equal to the inductor current ripple when the resonant frequency occurs well above the LM3639A's switching frequency;
- greater than the inductor current ripple when the resonant frequency occurs near the switching frequency; or
- less than the inductor current ripple when the resonant frequency occurs well below the switching frequency.

Figure 41 shows the series RLC circuit formed from the output impedance of the supply and the input capacitor. The circuit is re-drawn for the AC case where the V_{IN} supply is replaced with a short to GND, and the LM3639A + Inductor is replaced with a current source (ΔI_L).

Equation 1 is the criteria for an underdamped response. Equation 2 is the resonant frequency. Equation 3 is the approximated supply current ripple as a function of L_S , R_S , and C_{IN} .

As an example, consider a 3.6V supply with 0.1Ω of series resistance connected to C_{IN} through 50 nH of connecting traces. This results in an underdamped input filter circuit with a resonant frequency of 712 kHz. Since the switching frequency lies near to the resonant frequency of the input RLC network, the supply current is probably larger than the inductor current ripple. In this case, using Equation 3 from Figure 41, the supply current ripple can be approximated as 1.68 times the inductor current ripple. Increasing the series inductance (L_S) to 500 nH causes the resonant frequency to move to around 225 kHz and the supply current ripple to be approximately 0.25 times the inductor current ripple.

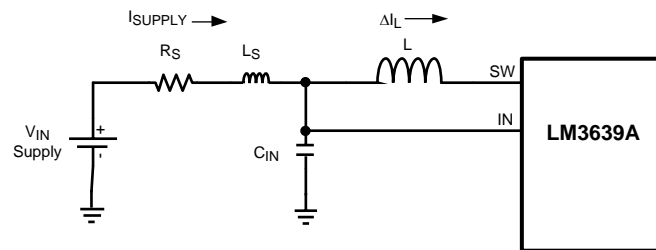

$$1. \frac{1}{L_S \times C_{IN}} > \frac{R_S^2}{4 \times L_S^2}$$

$$2. f_{RESONANT} = \frac{1}{2\pi \sqrt{L_S \times C_{IN}}}$$

$$3. I_{SUPPLYRIPPLE} \approx \Delta I_L \times \frac{1}{\sqrt{R_S^2 + \left(2\pi \times 500 \text{ kHz} \times L_S - \frac{1}{2\pi \times 500 \text{ kHz} \times C_{IN}}\right)^2}}$$

Figure 41. Input RLC Network

Applications Information: Flash

Output Capacitor Selection

The LM3639A's flash boost converter is designed to operate with a ceramic output capacitor of at least 10 μF . When the boost converter is running, the output capacitor supplies the load current during the boost converter's on-time. When the NMOS switch turns off, the inductor energy is discharged through the internal PMOS switch, supplying power to the load and restoring charge to the output capacitor. This causes a sag in the output voltage during the on-time and a rise in the output voltage during the off-time. The output capacitor is therefore chosen to limit the output ripple to an acceptable level depending on load current and input/output voltage differentials and also to ensure the converter remains stable.

Larger capacitors such as a 22 μF or capacitors in parallel can be used if lower output voltage ripple is desired. To estimate the output voltage ripple considering the ripple due to capacitor discharge (ΔV_Q) and the ripple due to the capacitors ESR (ΔV_{ESR}) use the following equations:

For continuous conduction mode, the output voltage ripple due to the capacitor discharge is:

$$\Delta V_Q = \frac{I_{\text{LED}} \times (V_{\text{OUT}} - V_{\text{IN}})}{f_{\text{SW}} \times V_{\text{OUT}} \times C_{\text{OUT}}} \quad (4)$$

The output voltage ripple due to the output capacitors ESR is found by:

$$\Delta V_{\text{ESR}} = R_{\text{ESR}} \times \left(\frac{I_{\text{LED}} \times V_{\text{OUT}}}{V_{\text{IN}}} \right) + \Delta I_L$$

where

$$\Delta I_L = \frac{V_{\text{IN}} \times (V_{\text{OUT}} - V_{\text{IN}})}{2 \times f_{\text{SW}} \times L \times V_{\text{OUT}}} \quad (5)$$

In ceramic capacitors the ESR is very low so the assumption is that 80% of the output voltage ripple is due to capacitor discharge and 20% from ESR. [Table 8](#) lists different manufacturers for various output capacitors and their case sizes suitable for use with the LM3639A.

Input Capacitor Selection

Choosing the correct size and type of input capacitor helps minimize the voltage ripple caused by the switching of the LM3639A's boost converter, and reduces noise on the boost converter's input terminal that can feed through and disrupt internal analog signals. In the Typical Application Circuit a 10 μF ceramic input capacitor works well. It is important to place the input capacitor as close as possible to the LM3639A's input (IN) terminal. This reduces the series resistance and inductance that can inject noise into the device due to the input switching currents. The table below lists various input capacitors recommended for use with the LM3639A.

Table 8. Recommended Flash Input/Output Capacitors (X5R/X7R Dielectric)

Manufacturer	Part Number	Value	Case Size	Voltage Rating
Murata	GRM155R60J106ME44D	10 μF	0402 (1mm \times 0.5mm \times 0.5mm)	6.3V
TDK Corporation	C1608JB0J106M	10 μF	0603 (1.6 mm \times 0.8 mm \times 0.8 mm)	6.3V
TDK Corporation	C2012JB1A106M	10 μF	0805 (2 mm \times 1.25 mm \times 1.25 mm)	10V
Murata	GRM188R60J106M	10 μF	0603 (1.6 mm \times 0.8 mm \times 0.8 mm)	6.3V
Murata	GRM21BR61A106KE19	10 μF	0805 (2 mm \times 1.25 mm \times 1.25 mm)	10V

Inductor Selection

The LM3639A's flash boost is designed to use a 1 μH or 0.47 μH inductor. [Table 9](#) below lists various inductors and their manufacturers that work well with the LM3639A. When the device is boosting ($V_{\text{OUT}} > V_{\text{IN}}$) the inductor will typically be the largest area of efficiency loss in the circuit. Therefore, choosing an inductor with the lowest possible series resistance is important. Additionally, the saturation rating of the inductor should be greater than the maximum operating peak current of the LM3639A. This prevents excess efficiency loss that can occur with inductors that operate in saturation. For proper inductor operation and circuit performance, ensure that the inductor saturation and the peak current limit setting of the LM3639A are greater than I_{PEAK} in the following calculation:

$$I_{PEAK} = \frac{I_{LOAD}}{\eta} \times \frac{V_{OUT}}{V_{IN}} + \Delta I_L \quad \text{where} \quad \Delta I_L = \frac{V_{IN} \times (V_{OUT} - V_{IN})}{2 \times f_{SW} \times L \times V_{OUT}} \quad (6)$$

where $f_{SW} = 4 \text{ MHz}$ or 2 MHz , and efficiency can be found in the Typical Performance Characteristics plots.

Table 9. Recommended Inductors

Manufacturer	L	Part Number	Dimensions (LxWxH)	I _{SAT}	R _{DC}
TOKO	1μH	DFE201612C-H-1R0M	2 mm x 1.6 mm x 1.2 mm	3.1A	68 mΩ
		DFE252010C	2.5 mm x 2 mm x 1 mm	3.4A	60 mΩ
		DFE252012C	2.5 mm x 2 mm x 1.2 mm	3.8A	45 mΩ

Flash Layout Recommendations

The high switching frequency and large switching currents of the LM3639A make the choice of layout important. The following steps should be used as a reference to ensure the device is stable and maintains proper LED current regulation across its intended operating voltage and current range.

1. Place C_{IN} on the top layer (same layer as the LM3639A) and as close to the device as possible. The input capacitor conducts the driver currents during the low-side MOSFET turn-on and turn-off and can see current spikes over 1A in amplitude. Connecting the input capacitor through short, wide traces to both the VIN and GND terminals will reduce the inductive voltage spikes that occur during switching which can corrupt the V_{IN} line.
2. Place C_{OUTF} on the top layer (same layer as the LM3639A) and as close as possible to the OUTF and GND terminals. The returns for both C_{IN} and C_{OUTF} should come together at one point, as close to the GND pin as possible. Connecting C_{OUTF} through short, wide traces will reduce the series inductance on the OUTF and GND terminals that can corrupt the V_{OUTF} and GND lines and cause excessive noise in the device and surrounding circuitry.
3. Connect the inductor on the top layer close to the SWF pin. There should be a low-impedance connection from the inductor to SWF due to the large DC inductor current, and at the same time the area occupied by the SW node should be small to reduce the capacitive coupling of the high dV/dt present at SW that can couple into nearby traces.
4. Avoid routing logic traces near the SWF node to avoid any capacitively coupled voltages from SW onto any high-impedance logic lines such as STROBE, EN, TX, PWM, SDA, and SCL. A good approach is to insert an inner layer GND plane underneath the SWF node and between any nearby routed traces. This creates a shield from the electric field generated at SW.
5. Terminate the Flash LED cathodes directly to the GND pin of the LM3639A. If possible, route the LED returns with a dedicated path to keep the high amplitude LED currents out of the GND plane. For Flash LEDs that are routed relatively far away from the LM3639A, a good approach is to sandwich the forward and return current paths over the top of each other on two layers. This will help reduce the inductance of the LED current paths.

PACKAGING INFORMATION

Orderable Device	Status (1)	Package Type	Package Drawing	Pins	Package Qty	Eco Plan (2)	Lead/Ball Finish	MSL Peak Temp (3)	Op Temp (°C)	Top-Side Markings (4)	Samples
LM3639AYFQR	ACTIVE	DSBGA	YFQ	20	3000	Green (RoHS & no Sb/Br)	SNAGCU	Level-1-260C-UNLIM	-40 to 85	363A	Samples
LM3639AYFQT	ACTIVE	DSBGA	YFQ	20	250	Green (RoHS & no Sb/Br)	SNAGCU	Level-1-260C-UNLIM	-40 to 85	363A	Samples

(1) The marketing status values are defined as follows:

ACTIVE: Product device recommended for new designs.

LIFEBUY: TI has announced that the device will be discontinued, and a lifetime-buy period is in effect.

NRND: Not recommended for new designs. Device is in production to support existing customers, but TI does not recommend using this part in a new design.

PREVIEW: Device has been announced but is not in production. Samples may or may not be available.

OBSOLETE: TI has discontinued the production of the device.

(2) Eco Plan - The planned eco-friendly classification: Pb-Free (RoHS), Pb-Free (RoHS Exempt), or Green (RoHS & no Sb/Br) - please check <http://www.ti.com/productcontent> for the latest availability information and additional product content details.

TBD: The Pb-Free/Green conversion plan has not been defined.

Pb-Free (RoHS): TI's terms "Lead-Free" or "Pb-Free" mean semiconductor products that are compatible with the current RoHS requirements for all 6 substances, including the requirement that lead not exceed 0.1% by weight in homogeneous materials. Where designed to be soldered at high temperatures, TI Pb-Free products are suitable for use in specified lead-free processes.

Pb-Free (RoHS Exempt): This component has a RoHS exemption for either 1) lead-based flip-chip solder bumps used between the die and package, or 2) lead-based die adhesive used between the die and leadframe. The component is otherwise considered Pb-Free (RoHS compatible) as defined above.

Green (RoHS & no Sb/Br): TI defines "Green" to mean Pb-Free (RoHS compatible), and free of Bromine (Br) and Antimony (Sb) based flame retardants (Br or Sb do not exceed 0.1% by weight in homogeneous material)

(3) MSL, Peak Temp. -- The Moisture Sensitivity Level rating according to the JEDEC industry standard classifications, and peak solder temperature.

(4) Multiple Top-Side Markings will be inside parentheses. Only one Top-Side Marking contained in parentheses and separated by a "~" will appear on a device. If a line is indented then it is a continuation of the previous line and the two combined represent the entire Top-Side Marking for that device.

Important Information and Disclaimer: The information provided on this page represents TI's knowledge and belief as of the date that it is provided. TI bases its knowledge and belief on information provided by third parties, and makes no representation or warranty as to the accuracy of such information. Efforts are underway to better integrate information from third parties. TI has taken and continues to take reasonable steps to provide representative and accurate information but may not have conducted destructive testing or chemical analysis on incoming materials and chemicals. TI and TI suppliers consider certain information to be proprietary, and thus CAS numbers and other limited information may not be available for release.

In no event shall TI's liability arising out of such information exceed the total purchase price of the TI part(s) at issue in this document sold by TI to Customer on an annual basis.

YFQ0020

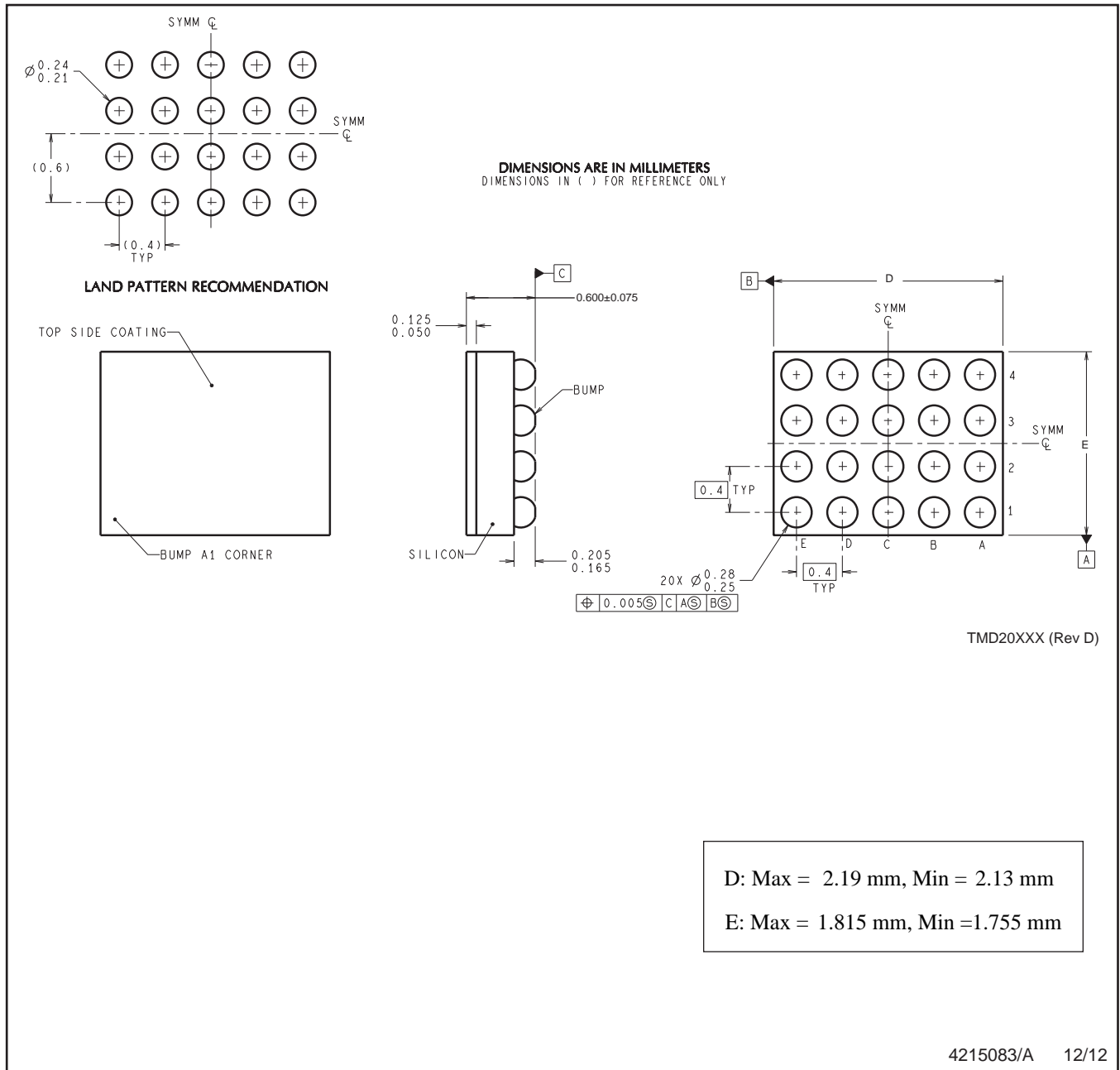

NOTES: A. All linear dimensions are in millimeters. Dimensioning and tolerancing per ASME Y14.5M-1994.
B. This drawing is subject to change without notice.

IMPORTANT NOTICE

Texas Instruments Incorporated (TI) reserves the right to make corrections, enhancements, improvements and other changes to its semiconductor products and services per JESD46, latest issue, and to discontinue any product or service per JESD48, latest issue. Buyers should obtain the latest relevant information before placing orders and should verify that such information is current and complete.

TI's published terms of sale for semiconductor products (<http://www.ti.com/sc/docs/stdterms.htm>) apply to the sale of packaged integrated circuit products that TI has qualified and released to market. Additional terms may apply to the use or sale of other types of TI products and services.

Reproduction of significant portions of TI information in TI data sheets is permissible only if reproduction is without alteration and is accompanied by all associated warranties, conditions, limitations, and notices. TI is not responsible or liable for such reproduced documentation. Information of third parties may be subject to additional restrictions. Resale of TI products or services with statements different from or beyond the parameters stated by TI for that product or service voids all express and any implied warranties for the associated TI product or service and is an unfair and deceptive business practice. TI is not responsible or liable for any such statements.

Buyers and others who are developing systems that incorporate TI products (collectively, "Designers") understand and agree that Designers remain responsible for using their independent analysis, evaluation and judgment in designing their applications and that Designers have full and exclusive responsibility to assure the safety of Designers' applications and compliance of their applications (and of all TI products used in or for Designers' applications) with all applicable regulations, laws and other applicable requirements. Designer represents that, with respect to their applications, Designer has all the necessary expertise to create and implement safeguards that (1) anticipate dangerous consequences of failures, (2) monitor failures and their consequences, and (3) lessen the likelihood of failures that might cause harm and take appropriate actions. Designer agrees that prior to using or distributing any applications that include TI products, Designer will thoroughly test such applications and the functionality of such TI products as used in such applications.

TI's provision of technical, application or other design advice, quality characterization, reliability data or other services or information, including, but not limited to, reference designs and materials relating to evaluation modules, (collectively, "TI Resources") are intended to assist designers who are developing applications that incorporate TI products; by downloading, accessing or using TI Resources in any way, Designer (individually or, if Designer is acting on behalf of a company, Designer's company) agrees to use any particular TI Resource solely for this purpose and subject to the terms of this Notice.

TI's provision of TI Resources does not expand or otherwise alter TI's applicable published warranties or warranty disclaimers for TI products, and no additional obligations or liabilities arise from TI providing such TI Resources. TI reserves the right to make corrections, enhancements, improvements and other changes to its TI Resources. TI has not conducted any testing other than that specifically described in the published documentation for a particular TI Resource.

Designer is authorized to use, copy and modify any individual TI Resource only in connection with the development of applications that include the TI product(s) identified in such TI Resource. NO OTHER LICENSE, EXPRESS OR IMPLIED, BY ESTOPPEL OR OTHERWISE TO ANY OTHER TI INTELLECTUAL PROPERTY RIGHT, AND NO LICENSE TO ANY TECHNOLOGY OR INTELLECTUAL PROPERTY RIGHT OF TI OR ANY THIRD PARTY IS GRANTED HEREIN, including but not limited to any patent right, copyright, mask work right, or other intellectual property right relating to any combination, machine, or process in which TI products or services are used. Information regarding or referencing third-party products or services does not constitute a license to use such products or services, or a warranty or endorsement thereof. Use of TI Resources may require a license from a third party under the patents or other intellectual property of the third party, or a license from TI under the patents or other intellectual property of TI.

TI RESOURCES ARE PROVIDED "AS IS" AND WITH ALL FAULTS. TI DISCLAIMS ALL OTHER WARRANTIES OR REPRESENTATIONS, EXPRESS OR IMPLIED, REGARDING RESOURCES OR USE THEREOF, INCLUDING BUT NOT LIMITED TO ACCURACY OR COMPLETENESS, TITLE, ANY EPIDEMIC FAILURE WARRANTY AND ANY IMPLIED WARRANTIES OF MERCHANTABILITY, FITNESS FOR A PARTICULAR PURPOSE, AND NON-INFRINGEMENT OF ANY THIRD PARTY INTELLECTUAL PROPERTY RIGHTS. TI SHALL NOT BE LIABLE FOR AND SHALL NOT DEFEND OR INDEMNIFY DESIGNER AGAINST ANY CLAIM, INCLUDING BUT NOT LIMITED TO ANY INFRINGEMENT CLAIM THAT RELATES TO OR IS BASED ON ANY COMBINATION OF PRODUCTS EVEN IF DESCRIBED IN TI RESOURCES OR OTHERWISE. IN NO EVENT SHALL TI BE LIABLE FOR ANY ACTUAL, DIRECT, SPECIAL, COLLATERAL, INDIRECT, PUNITIVE, INCIDENTAL, CONSEQUENTIAL OR EXEMPLARY DAMAGES IN CONNECTION WITH OR ARISING OUT OF TI RESOURCES OR USE THEREOF, AND REGARDLESS OF WHETHER TI HAS BEEN ADVISED OF THE POSSIBILITY OF SUCH DAMAGES.

Unless TI has explicitly designated an individual product as meeting the requirements of a particular industry standard (e.g., ISO/TS 16949 and ISO 26262), TI is not responsible for any failure to meet such industry standard requirements.

Where TI specifically promotes products as facilitating functional safety or as compliant with industry functional safety standards, such products are intended to help enable customers to design and create their own applications that meet applicable functional safety standards and requirements. Using products in an application does not by itself establish any safety features in the application. Designers must ensure compliance with safety-related requirements and standards applicable to their applications. Designer may not use any TI products in life-critical medical equipment unless authorized officers of the parties have executed a special contract specifically governing such use. Life-critical medical equipment is medical equipment where failure of such equipment would cause serious bodily injury or death (e.g., life support, pacemakers, defibrillators, heart pumps, neurostimulators, and implantables). Such equipment includes, without limitation, all medical devices identified by the U.S. Food and Drug Administration as Class III devices and equivalent classifications outside the U.S.

TI may expressly designate certain products as completing a particular qualification (e.g., Q100, Military Grade, or Enhanced Product). Designers agree that it has the necessary expertise to select the product with the appropriate qualification designation for their applications and that proper product selection is at Designers' own risk. Designers are solely responsible for compliance with all legal and regulatory requirements in connection with such selection.

Designer will fully indemnify TI and its representatives against any damages, costs, losses, and/or liabilities arising out of Designer's non-compliance with the terms and provisions of this Notice.