



**THE DATASHEET OF
NJVMJD31CT4G-VF01**



MJD31 (NPN), MJD32 (PNP)

Complementary Power Transistors

DPAK For Surface Mount Applications

Designed for general purpose amplifier and low speed switching applications.

Features

- Lead Formed for Surface Mount Applications in Plastic Sleeves
- Straight Lead Version in Plastic Sleeves (“1” Suffix)
- Lead Formed Version in 16 mm Tape and Reel (“T4” Suffix)
- Electrically Similar to Popular TIP31 and TIP32 Series
- Epoxy Meets UL 94, V-0 @ 0.125 in
- NJV Prefix for Automotive and Other Applications Requiring Unique Site and Control Change Requirements; AEC-Q101 Qualified and PPAP Capable
- These Devices are Pb-Free and are RoHS Compliant

MAXIMUM RATINGS

Rating	Symbol	Max	Unit
Collector-Emitter Voltage MJD31, MJD32 MJD31C, MJD32C	V_{CEO}	40 100	Vdc
Collector-Base Voltage MJD31, MJD32 MJD31C, MJD32C	V_{CB}	40 100	Vdc
Emitter-Base Voltage	V_{EB}	5.0	Vdc
Collector Current – Continuous	I_C	3.0	Adc
Collector Current – Peak	I_{CM}	5.0	Adc
Base Current	I_B	1.0	Adc
Total Power Dissipation @ $T_C = 25^\circ\text{C}$ Derate above 25°C	P_D	15 0.12	W W/ $^\circ\text{C}$
Total Power Dissipation @ $T_A = 25^\circ\text{C}$ Derate above 25°C	P_D	1.56 0.012	W W/ $^\circ\text{C}$
Operating and Storage Junction Temperature Range	T_J, T_{stg}	-65 to +150	$^\circ\text{C}$
ESD – Human Body Model	HBM	3B	V
ESD – Machine Model	MM	C	V

Stresses exceeding those listed in the Maximum Ratings table may damage the device. If any of these limits are exceeded, device functionality should not be assumed, damage may occur and reliability may be affected.

THERMAL CHARACTERISTICS

Characteristic	Symbol	Max	Unit
Thermal Resistance, Junction-to-Case	$R_{\theta JC}$	8.3	$^\circ\text{C}/\text{W}$
Thermal Resistance, Junction-to-Ambient*	$R_{\theta JA}$	80	$^\circ\text{C}/\text{W}$
Lead Temperature for Soldering Purposes	T_L	260	$^\circ\text{C}$

*These ratings are applicable when surface mounted on the minimum pad sizes recommended.



ON Semiconductor®

www.onsemi.com

**SILICON
POWER TRANSISTORS
3 AMPERES
40 AND 100 VOLTS
15 WATTS**

COMPLEMENTARY

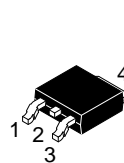
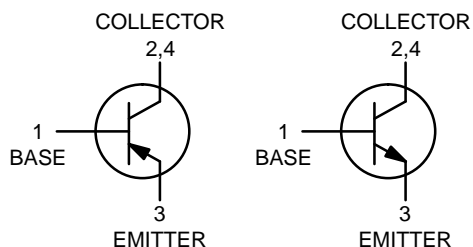

**DPAK
CASE 369C
STYLE 1**

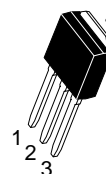

**IPAK
CASE 369D
STYLE 1**

MARKING DIAGRAMS

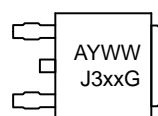

DPAK

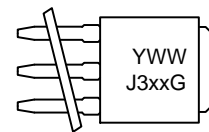

IPAK

A = Site Code
Y = Year
WW = Work Week
xx = 1, 1C, 2, or 2C
G = Pb-Free Package

ORDERING INFORMATION

See detailed ordering and shipping information in the package dimensions section on page 8 of this data sheet.

MJD31 (NPN), MJD32 (PNP)

ELECTRICAL CHARACTERISTICS ($T_C = 25^\circ\text{C}$ unless otherwise noted)

Characteristic	Symbol	Min	Max	Unit
----------------	--------	-----	-----	------

OFF CHARACTERISTICS

Collector–Emitter Sustaining Voltage (Note 1) ($I_C = 30\text{ mAdc}$, $I_B = 0$) MJD31, MJD32 MJD31C, MJD32C	$V_{CEO(sus)}$	40 100	– –	Vdc
Collector Cutoff Current ($V_{CE} = 40\text{ Vdc}$, $I_B = 0$) MJD31, MJD32 ($V_{CE} = 60\text{ Vdc}$, $I_B = 0$) MJD31C, MJD32C	I_{CEO}	– –	50 50	$\mu\text{A dc}$
Collector Cutoff Current ($V_{CE} = \text{Rated } V_{CEO}$, $V_{EB} = 0$)	ICES	–	20	$\mu\text{A dc}$
Emitter Cutoff Current ($V_{BE} = 5\text{ Vdc}$, $I_C = 0$)	I_{EBO}	–	1	mA dc

ON CHARACTERISTICS (Note 1)

DC Current Gain ($I_C = 1\text{ A dc}$, $V_{CE} = 4\text{ Vdc}$) ($I_C = 3\text{ A dc}$, $V_{CE} = 4\text{ Vdc}$)	h_{FE}	25 10	– 50	
Collector–Emitter Saturation Voltage ($I_C = 3\text{ A dc}$, $I_B = 375\text{ mA dc}$)	$V_{CE(sat)}$	–	1.2	Vdc
Base–Emitter On Voltage ($I_C = 3\text{ A dc}$, $V_{CE} = 4\text{ Vdc}$)	$V_{BE(on)}$	–	1.8	Vdc

DYNAMIC CHARACTERISTICS

Current Gain – Bandwidth Product (Note 2) ($I_C = 500\text{ mA dc}$, $V_{CE} = 10\text{ Vdc}$, $f_{test} = 1\text{ MHz}$)	f_T	3	–	MHz
Small–Signal Current Gain ($I_C = 0.5\text{ A dc}$, $V_{CE} = 10\text{ Vdc}$, $f = 1\text{ kHz}$)	h_{fe}	20	–	

Product parametric performance is indicated in the Electrical Characteristics for the listed test conditions, unless otherwise noted. Product performance may not be indicated by the Electrical Characteristics if operated under different conditions.

1. Pulse Test: Pulse Width $\leq 300\ \mu\text{s}$, Duty Cycle $\leq 2\%$.
2. $f_T = |h_{fe}| \cdot f_{test}$.

MJD31 (NPN), MJD32 (PNP)

TYPICAL CHARACTERISTICS

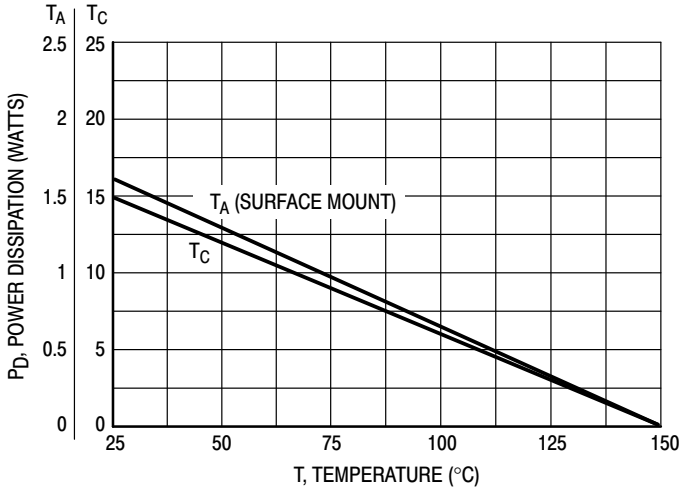
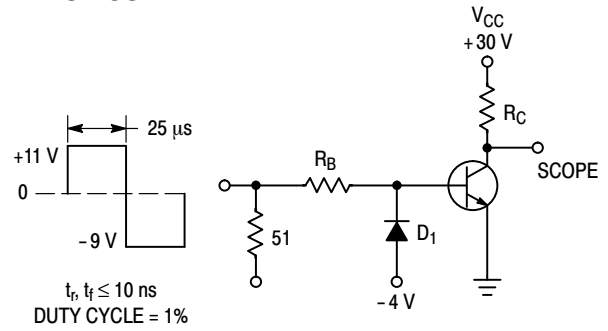

Figure 1. Power Derating



R_B and R_C VARIED TO OBTAIN DESIRED CURRENT LEVELS
 D_1 MUST BE FAST RECOVERY TYPE, e.g.:
 1N5825 USED ABOVE $I_B \approx 100$ mA
 MSD6100 USED BELOW $I_B \approx 100$ mA
 REVERSE ALL POLARITIES FOR PNP.

Figure 2. Switching Time Test Circuit

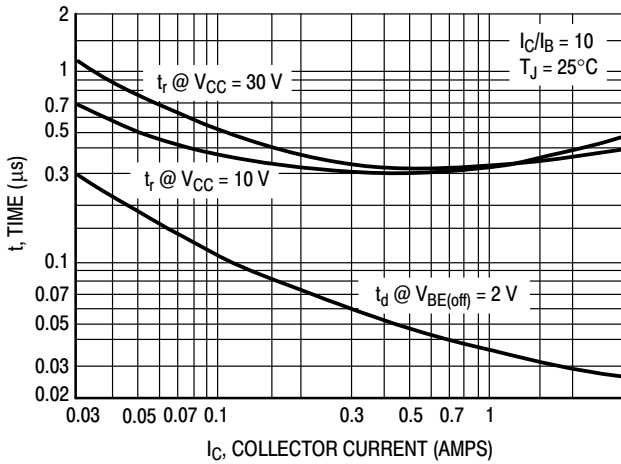

Figure 3. Turn-On Time

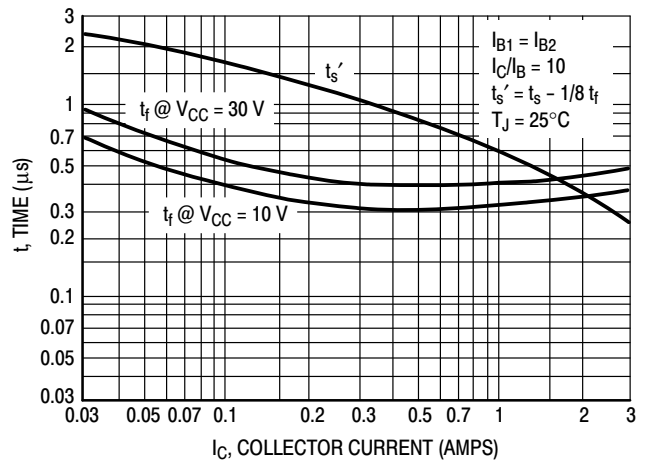

Figure 4. Turn-Off Time

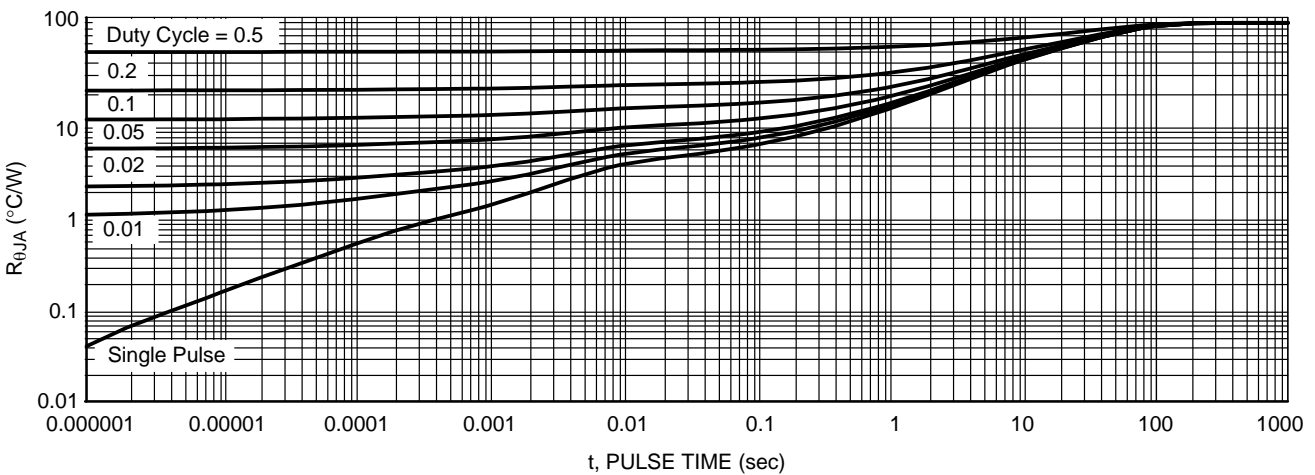

Figure 5. Thermal Response

MJD31 (NPN), MJD32 (PNP)

TYPICAL CHARACTERISTICS – MJD31, MJD31C (NPN)

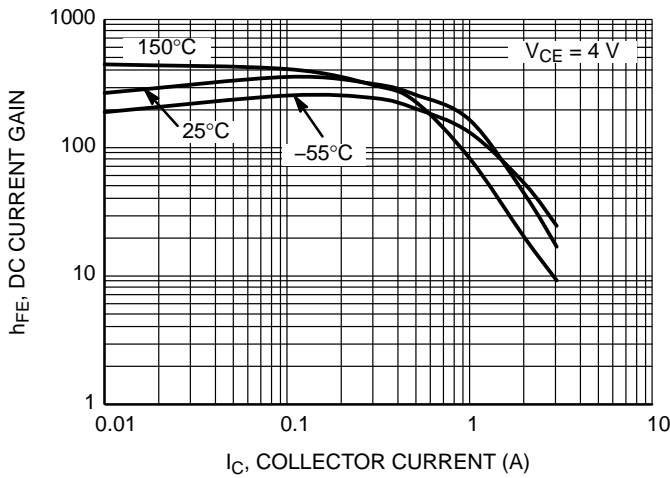

Figure 6. DC Current Gain at $V_{CE} = 4\text{ V}$

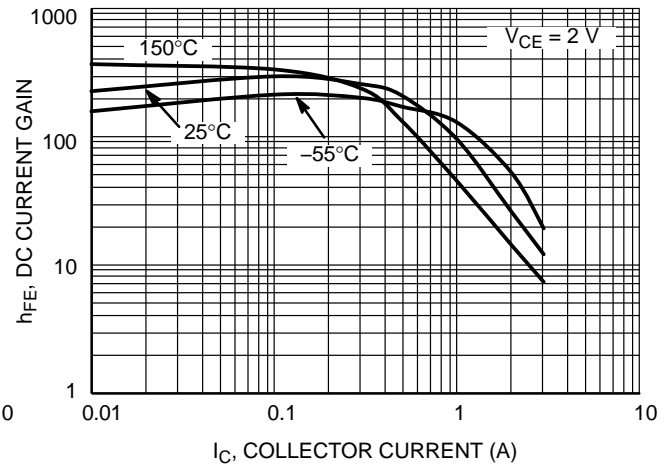

Figure 7. DC Current Gain at $V_{CE} = 2\text{ V}$

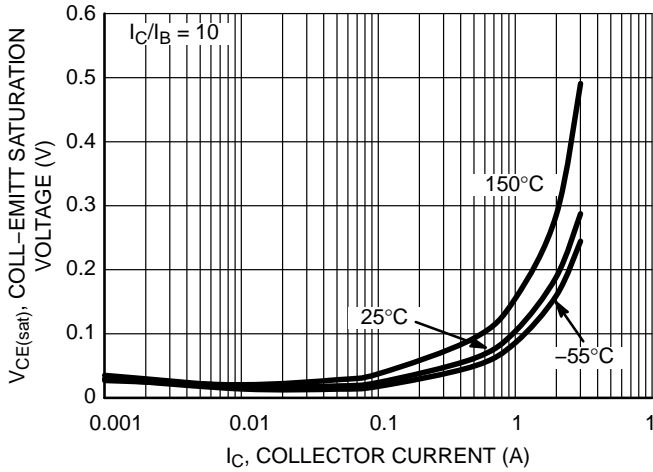

Figure 8. Collector-Emitt Saturation Voltage

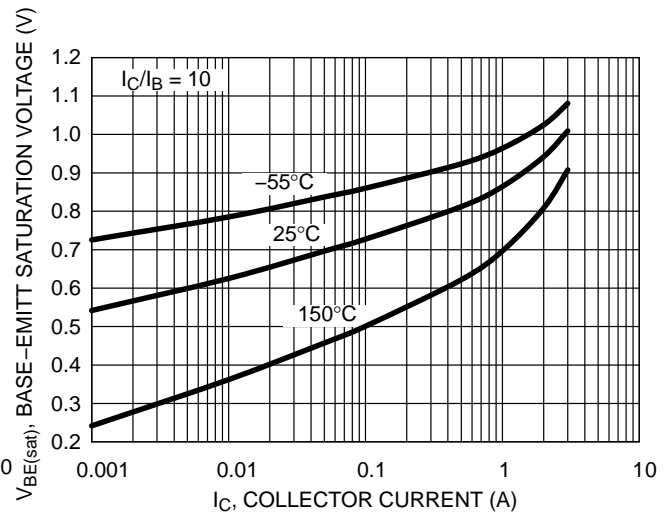

Figure 9. Base-Emitt Saturation Voltage

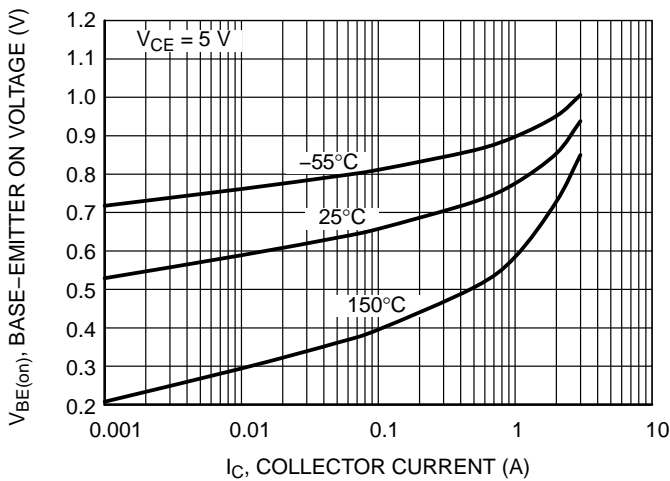

Figure 10. Base-Emitt "On" Voltage

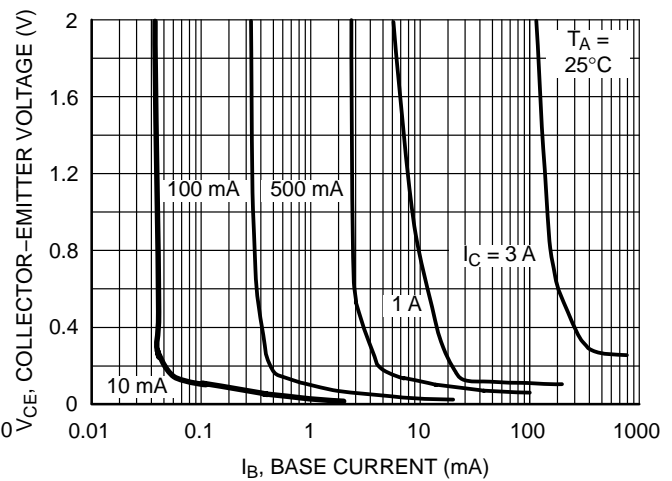

Figure 11. Collector Saturation Region

MJD31 (NPN), MJD32 (PNP)

TYPICAL CHARACTERISTICS – MJD31, MJD31C (NPN)

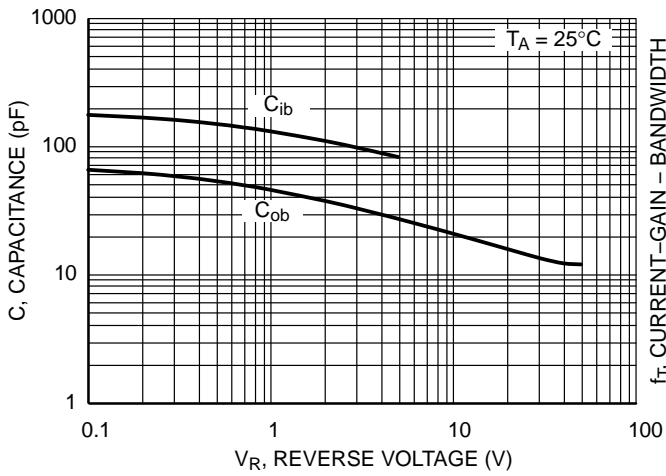

Figure 12. Capacitance

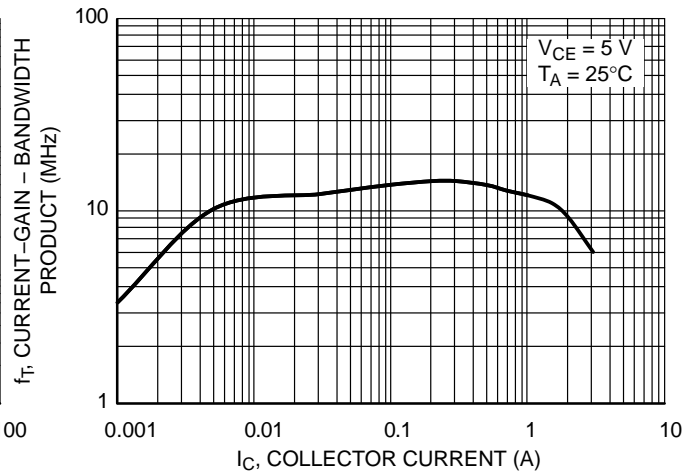

Figure 13. Current-Gain-Bandwidth Product

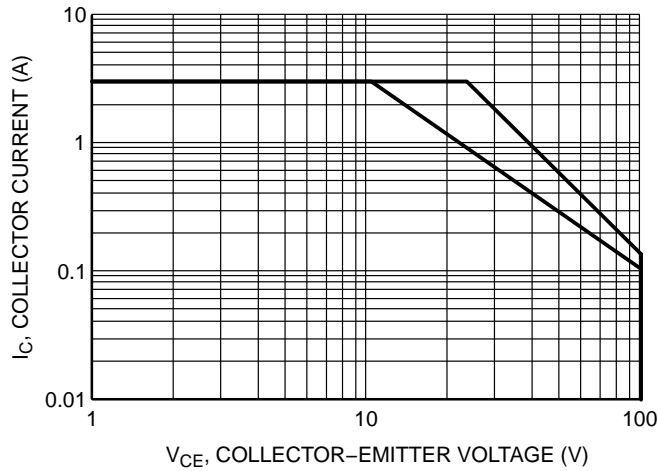

Figure 14. Safe Operating Area

MJD31 (NPN), MJD32 (PNP)

TYPICAL CHARACTERISTICS – MJD32, MJD32C (PNP)

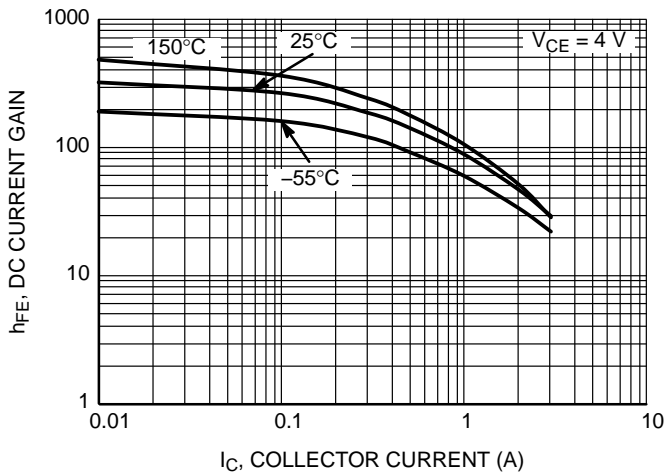

Figure 15. DC Current Gain at $V_{CE} = 4\text{ V}$

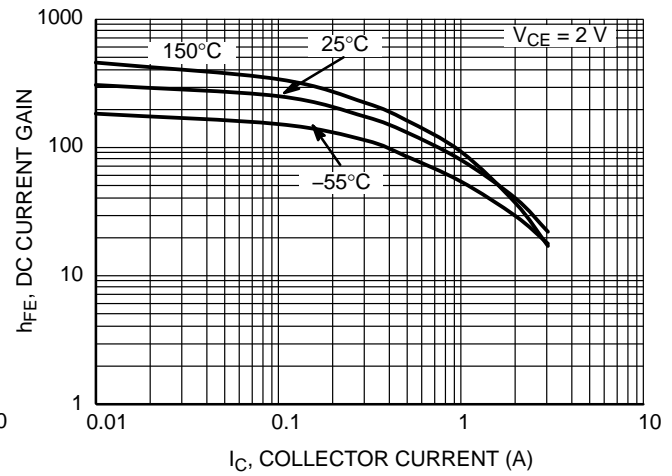

Figure 16. DC Current Gain at $V_{CE} = 2\text{ V}$

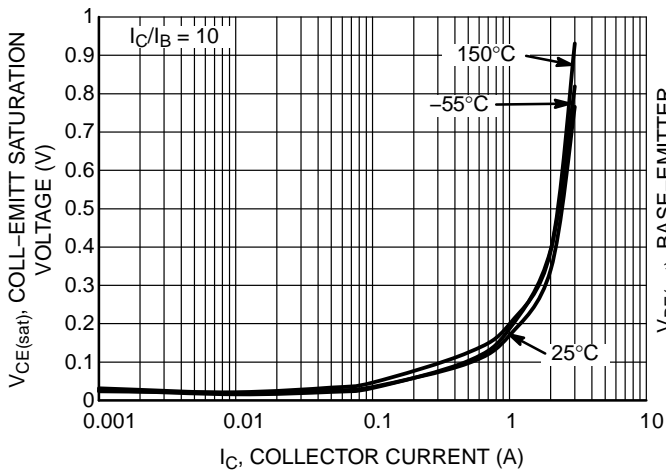

Figure 17. Collector-Emitter Saturation Voltage

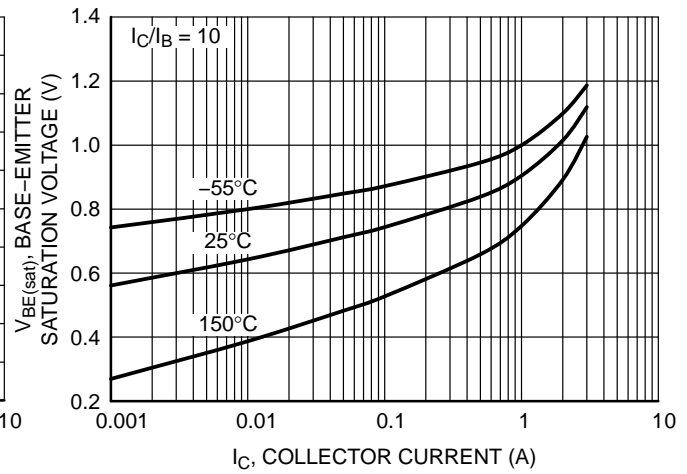

Figure 18. Base-Emitter Saturation Voltage

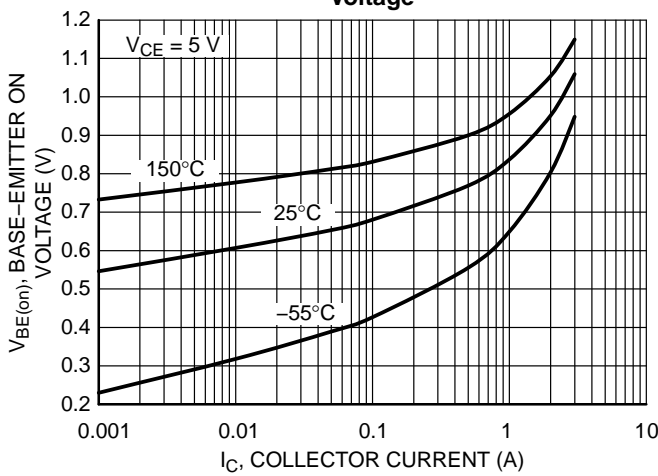

Figure 19. Base-Emitter "On" Voltage

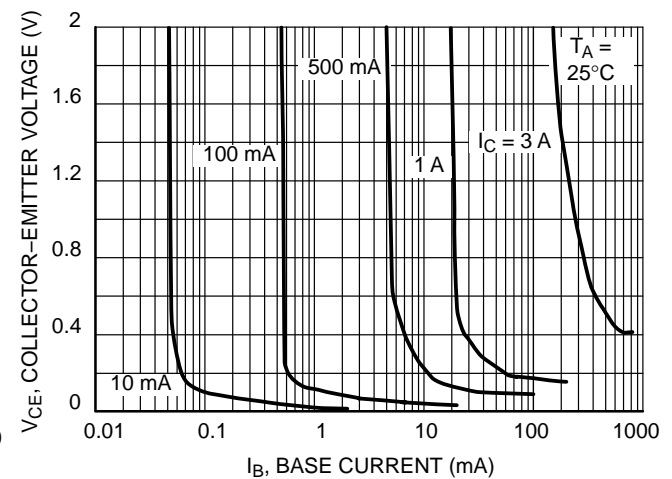

Figure 20. Collector Saturation Region

MJD31 (NPN), MJD32 (PNP)

TYPICAL CHARACTERISTICS

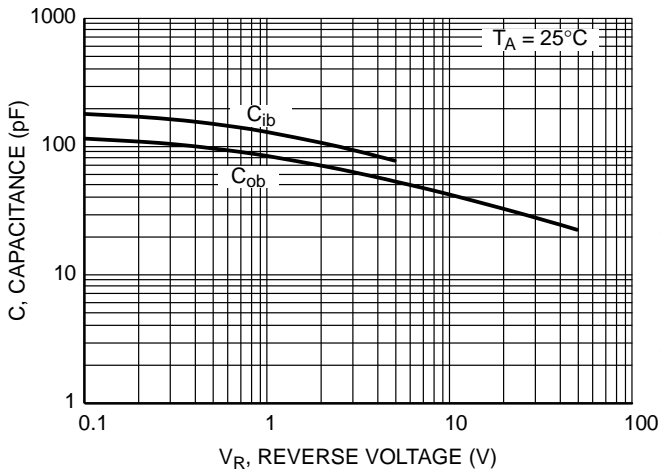

Figure 21. Capacitance

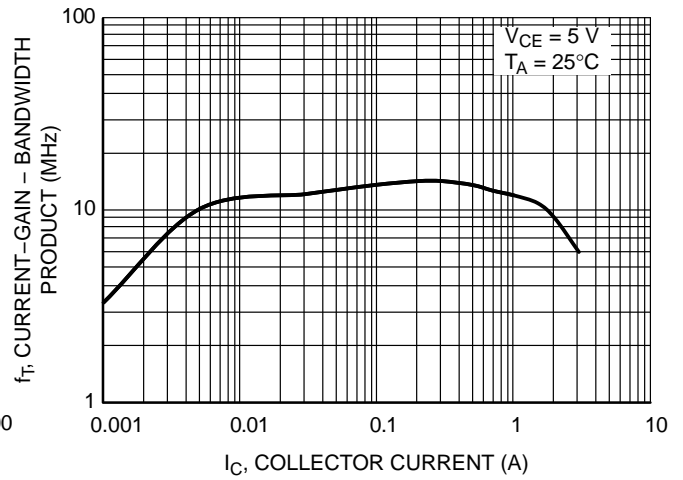

Figure 22. Current-Gain-Bandwidth Product

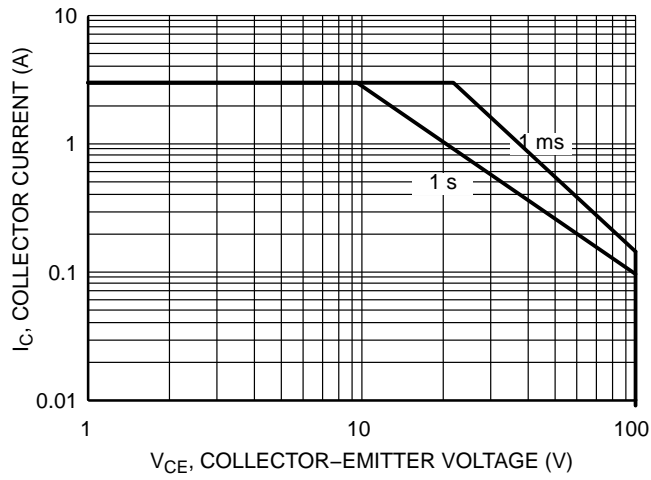

Figure 23. Safe Operating Area

MJD31 (NPN), MJD32 (PNP)

ORDERING INFORMATION

Device	Package Type	Package	Shipping [†]
MJD31CG	DPAK (Pb-Free)	369C	75 Units / Rail
NJVMJD31CG*	DPAK (Pb-Free)	369C	75 Units / Rail
MJD31C1G	IPAK (Pb-Free)	369D	75 Units / Rail
MJD31CRLG	DPAK (Pb-Free)	369C	1,800 / Tape & Reel
NJVMJD31CRLG*	DPAK (Pb-Free)	369C	1,800 / Tape & Reel
MJD31CT4G	DPAK (Pb-Free)	369C	2,500 / Tape & Reel
NJVMJD31CT4G*	DPAK (Pb-Free)	369C	2,500 / Tape & Reel
MJD31T4G	DPAK (Pb-Free)	369C	2,500 / Tape & Reel
NJVMJD31T4G*	DPAK (Pb-Free)	369C	2,500 / Tape & Reel
MJD32CG	DPAK (Pb-Free)	369C	75 Units / Rail
NJVMJD32CG*	DPAK (Pb-Free)	369C	75 Units / Rail
MJD32CRLG	DPAK (Pb-Free)	369C	1,800 / Tape & Reel
MJD32CT4G	DPAK (Pb-Free)	369C	2,500 / Tape & Reel
NJVMJD32CT4G*	DPAK (Pb-Free)	369C	2,500 / Tape & Reel
MJD32RLG	DPAK (Pb-Free)	369C	1,800 / Tape & Reel
MJD32T4G	DPAK (Pb-Free)	369C	2,500 / Tape & Reel
NJVMJD32T4G*	DPAK (Pb-Free)	369C	2,500 / Tape & Reel

†For information on tape and reel specifications, including part orientation and tape sizes, please refer to our Tape and Reel Packaging Specifications Brochure, BRD8011/D.

*NJV Prefix for Automotive and Other Applications Requiring Unique Site and Control Change Requirements; AEC-Q101 Qualified and PPAP Capable.

MJD31 (NPN), MJD32 (PNP)

PACKAGE DIMENSIONS

DPAK (SINGLE GAUGE) CASE 369C ISSUE F

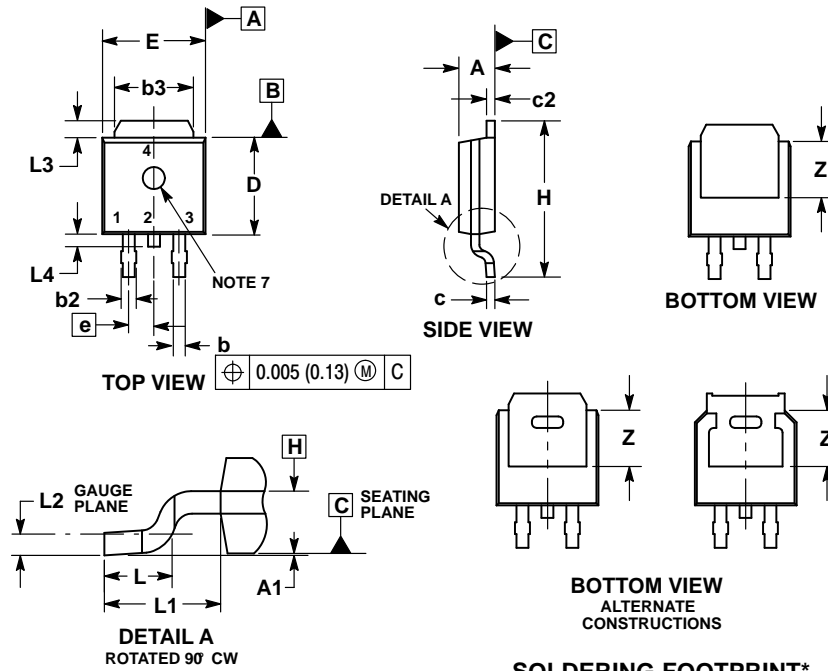

NOTES:

1. DIMENSIONING AND TOLERANCING PER ASME Y14.5M, 1994.
2. CONTROLLING DIMENSION: INCHES.
3. THERMAL PAD CONTOUR OPTIONAL WITHIN DIMENSIONS b3, L3 and Z.
4. DIMENSIONS D AND E DO NOT INCLUDE MOLD FLASH, PROTRUSIONS, OR BURRS. MOLD FLASH, PROTRUSIONS, OR GATE BURRS SHALL NOT EXCEED 0.006 INCHES PER SIDE.
5. DIMENSIONS D AND E ARE DETERMINED AT THE OUTERMOST EXTREMES OF THE PLASTIC BODY.
6. DATUMS A AND B ARE DETERMINED AT DATUM PLANE H.
7. OPTIONAL MOLD FEATURE.

DIM	INCHES		MILLIMETERS	
	MIN	MAX	MIN	MAX
A	0.086	0.094	2.18	2.38
A1	0.000	0.005	0.00	0.13
b	0.025	0.035	0.63	0.89
b2	0.028	0.045	0.72	1.14
b3	0.180	0.215	4.57	5.46
c	0.018	0.024	0.46	0.61
c2	0.018	0.024	0.46	0.61
D	0.235	0.245	5.97	6.22
E	0.250	0.265	6.35	6.73
e	0.090 BSC		2.29 BSC	
H	0.370	0.410	9.40	10.41
L	0.055	0.070	1.40	1.78
L1	0.114 REF		2.90 REF	
L2	0.020 BSC		0.51 BSC	
L3	0.035	0.050	0.89	1.27
L4	---	0.040	---	1.01
Z	0.155	---	3.93	---

SOLDERING FOOTPRINT*

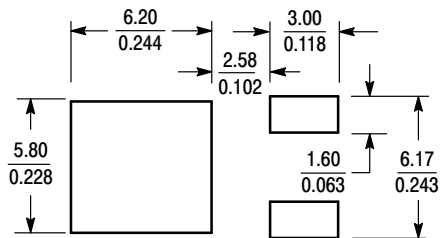

SCALE 3:1 $\left(\frac{\text{mm}}{\text{inches}}\right)$

STYLE 1:

1. BASE
2. COLLECTOR
3. EMITTER
4. COLLECTOR

*For additional information on our Pb-Free strategy and soldering details, please download the ON Semiconductor Soldering and Mounting Techniques Reference Manual, SOLDERRM/D.

MJD31 (NPN), MJD32 (PNP)

PACKAGE DIMENSIONS

IPAK CASE 369D ISSUE C

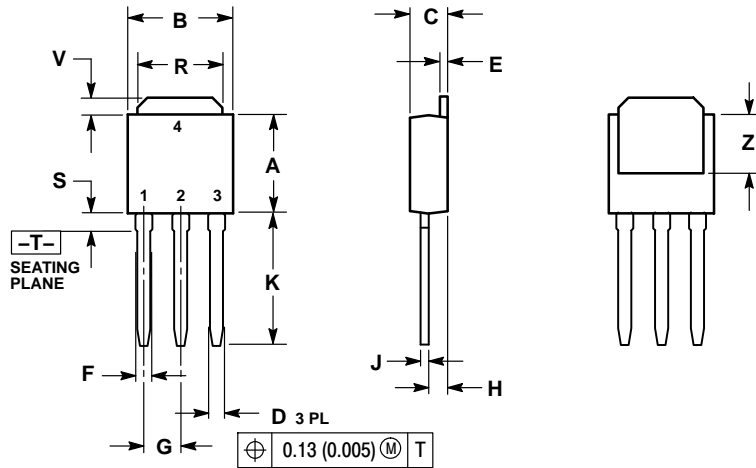

- NOTES:
1. DIMENSIONING AND TOLERANCING PER ANSI Y14.5M, 1982.
2. CONTROLLING DIMENSION: INCH.

DIM	INCHES		MILLIMETERS	
	MIN	MAX	MIN	MAX
A	0.235	0.245	5.97	6.35
B	0.250	0.265	6.35	6.73
C	0.086	0.094	2.19	2.38
D	0.027	0.035	0.69	0.88
E	0.018	0.023	0.46	0.58
F	0.037	0.045	0.94	1.14
G	0.090	BSC	2.29	BSC
H	0.034	0.040	0.87	1.01
J	0.018	0.023	0.46	0.58
K	0.350	0.380	8.89	9.65
R	0.180	0.215	4.45	5.45
S	0.025	0.040	0.63	1.01
V	0.035	0.050	0.89	1.27
Z	0.155	---	3.93	---

- STYLE 1:
PIN 1. BASE
2. COLLECTOR
3. EMITTER
4. COLLECTOR

ON Semiconductor and are trademarks of Semiconductor Components Industries, LLC dba ON Semiconductor or its subsidiaries in the United States and/or other countries. ON Semiconductor owns the rights to a number of patents, trademarks, copyrights, trade secrets, and other intellectual property. A listing of ON Semiconductor's product/patent coverage may be accessed at www.onsemi.com/site/pdf/Patent-Marking.pdf. ON Semiconductor reserves the right to make changes without further notice to any products herein. ON Semiconductor makes no warranty, representation or guarantee regarding the suitability of its products for any particular purpose, nor does ON Semiconductor assume any liability arising out of the application or use of any product or circuit, and specifically disclaims any and all liability, including without limitation special, consequential or incidental damages. Buyer is responsible for its products and applications using ON Semiconductor products, including compliance with all laws, regulations and safety requirements or standards, regardless of any support or applications information provided by ON Semiconductor. "Typical" parameters which may be provided in ON Semiconductor data sheets and/or specifications can and do vary in different applications and actual performance may vary over time. All operating parameters, including "Typicals" must be validated for each customer application by customer's technical experts. ON Semiconductor does not convey any license under its patent rights nor the rights of others. ON Semiconductor products are not designed, intended, or authorized for use as a critical component in life support systems or any FDA Class 3 medical devices or medical devices with a same or similar classification in a foreign jurisdiction or any devices intended for implantation in the human body. Should Buyer purchase or use ON Semiconductor products for any such unintended or unauthorized application, Buyer shall indemnify and hold ON Semiconductor and its officers, employees, subsidiaries, affiliates, and distributors harmless against all claims, costs, damages, and expenses, and reasonable attorney fees arising out of, directly or indirectly, any claim of personal injury or death associated with such unintended or unauthorized use, even if such claim alleges that ON Semiconductor was negligent regarding the design or manufacture of the part. ON Semiconductor is an Equal Opportunity/Affirmative Action Employer. This literature is subject to all applicable copyright laws and is not for resale in any manner.

PUBLICATION ORDERING INFORMATION

LITERATURE FULFILLMENT:
Literature Distribution Center for ON Semiconductor
19521 E. 32nd Pkwy, Aurora, Colorado 80011 USA
Phone: 303-675-2175 or 800-344-3860 Toll Free USA/Canada
Fax: 303-675-2176 or 800-344-3867 Toll Free USA/Canada
Email: orderlit@onsemi.com

N. American Technical Support: 800-282-9855 Toll Free
USA/Canada
Europe, Middle East and Africa Technical Support:
Phone: 421 33 790 2910
Japan Customer Focus Center
Phone: 81-3-5817-1050

ON Semiconductor Website: www.onsemi.com
Order Literature: <http://www.onsemi.com/orderlit>

For additional information, please contact your local Sales Representative