

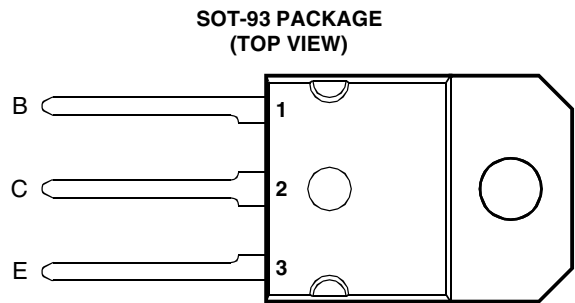

# THE DATASHEET OF TIPL762A-S



- Rugged Triple-Diffused Planar Construction
- 6 A Continuous Collector Current
- Operating Characteristics Fully Guaranteed at 100°C
- 1000 Volt Blocking Capability
- 120 W at 25°C Case Temperature



Pin 2 is in electrical contact with the mounting base.

MDTRAAA

**absolute maximum ratings at 25°C case temperature (unless otherwise noted)**

RATING		SYMBOL	VALUE	UNIT
Collector-base voltage ( $I_E = 0$ )	TIPL762	$V_{CBO}$	850	V
	TIPL762A		1000	
Collector-emitter voltage ( $V_{BE} = 0$ )	TIPL762	$V_{CES}$	850	V
	TIPL762A		1000	
Collector-emitter voltage ( $I_B = 0$ )	TIPL762	$V_{CEO}$	400	V
	TIPL762A		450	
Emitter-base voltage		$V_{EBO}$	10	V
Continuous collector current		$I_C$	6	A
Peak collector current (see Note 1)		$I_{CM}$	12	A
Continuous device dissipation at (or below) 25°C case temperature		$P_{tot}$	120	W
Operating junction temperature range		$T_j$	-65 to +150	°C
Storage temperature range		$T_{stg}$	-65 to +150	°C

NOTE 1: This value applies for  $t_p \leq 10$  ms, duty cycle  $\leq 2\%$ .

**PRODUCT INFORMATION**

**electrical characteristics at 25°C case temperature (unless otherwise noted)**

PARAMETER	TEST CONDITIONS			MIN	TYP	MAX	UNIT
$V_{CE(sus)}$ Collector-emitter sustaining voltage	$I_C = 100 \text{ mA}$	$L = 25 \text{ mH}$	(see Note 2)	TIPL762 400			V
$I_{CES}$ Collector-emitter cut-off current	$V_{CE} = 850 \text{ V}$	$V_{BE} = 0$		TIPL762		50	$\mu\text{A}$
	$V_{CE} = 1000 \text{ V}$	$V_{BE} = 0$		TIPL762A		50	
	$V_{CE} = 850 \text{ V}$	$V_{BE} = 0$	$T_C = 100^\circ\text{C}$	TIPL762		200	
	$V_{CE} = 1000 \text{ V}$	$V_{BE} = 0$	$T_C = 100^\circ\text{C}$	TIPL762A		200	
$I_{CEO}$ Collector cut-off current	$V_{CE} = 400 \text{ V}$	$I_B = 0$		TIPL762		50	$\mu\text{A}$
	$V_{CE} = 450 \text{ V}$	$I_B = 0$		TIPL762A		50	
$I_{EBO}$ Emitter cut-off current	$V_{EB} = 10 \text{ V}$	$I_C = 0$				1	mA
$h_{FE}$ Forward current transfer ratio	$V_{CE} = 5 \text{ V}$	$I_C = 0.5 \text{ A}$	(see Notes 3 and 4)	20		60	
$V_{CE(sat)}$ Collector-emitter saturation voltage	$I_B = 0.4 \text{ A}$	$I_C = 2 \text{ A}$	(see Notes 3 and 4)			0.5	V
	$I_B = 0.8 \text{ A}$	$I_C = 4 \text{ A}$				1.0	
	$I_B = 1.2 \text{ A}$	$I_C = 6 \text{ A}$				2.5	
	$I_B = 1.2 \text{ A}$	$I_C = 6 \text{ A}$		$T_C = 100^\circ\text{C}$			
$V_{BE(sat)}$ Base-emitter saturation voltage	$I_B = 0.4 \text{ A}$	$I_C = 2 \text{ A}$	(see Notes 3 and 4)			1.1	V
	$I_B = 0.8 \text{ A}$	$I_C = 4 \text{ A}$				1.3	
	$I_B = 1.2 \text{ A}$	$I_C = 6 \text{ A}$				1.5	
	$I_B = 1.2 \text{ A}$	$I_C = 6 \text{ A}$		$T_C = 100^\circ\text{C}$			
$f_t$ Current gain bandwidth product	$V_{CE} = 10 \text{ V}$	$I_C = 0.5 \text{ A}$	$f = 1 \text{ MHz}$		6		MHz
$C_{ob}$ Output capacitance	$V_{CB} = 20 \text{ V}$	$I_E = 0$	$f = 0.1 \text{ MHz}$		105		pF

- NOTES: 2. Inductive loop switching measurement.  
 3. These parameters must be measured using pulse techniques,  $t_p = 300 \mu\text{s}$ , duty cycle  $\leq 2\%$ .  
 4. These parameters must be measured using voltage-sensing contacts, separate from the current carrying contacts.

**thermal characteristics**

PARAMETER	MIN	TYP	MAX	UNIT
$R_{\theta JC}$ Junction to case thermal resistance			1.25	$^\circ\text{C/W}$

**inductive-load-switching characteristics at 25°C case temperature (unless otherwise noted)**

PARAMETER	TEST CONDITIONS †			MIN	TYP	MAX	UNIT
$t_{sv}$ Voltage storage time	$I_C = 6 \text{ A}$ $V_{BE(off)} = -10 \text{ V}$	$I_{B(on)} = 1.2 \text{ A}$	(see Figures 1 and 2)			2.5	$\mu\text{s}$
$t_{rv}$ Voltage rise time						200	ns
$t_{fi}$ Current fall time						150	ns
$t_{ti}$ Current tail time						50	ns
$t_{xo}$ Cross over time						300	ns
$t_{sv}$ Voltage storage time	$I_C = 6 \text{ A}$ $V_{BE(off)} = -10 \text{ V}$	$I_{B(on)} = 1.2 \text{ A}$	(see Figures 1 and 2)			3	$\mu\text{s}$
$t_{rv}$ Voltage rise time						300	ns
$t_{fi}$ Current fall time						150	ns
$t_{ti}$ Current tail time					$T_C = 100^\circ\text{C}$	50	ns
$t_{xo}$ Cross over time						500	ns

† Voltage and current values shown are nominal; exact values vary slightly with transistor parameters.

**PRODUCT INFORMATION**



TYPICAL CHARACTERISTICS

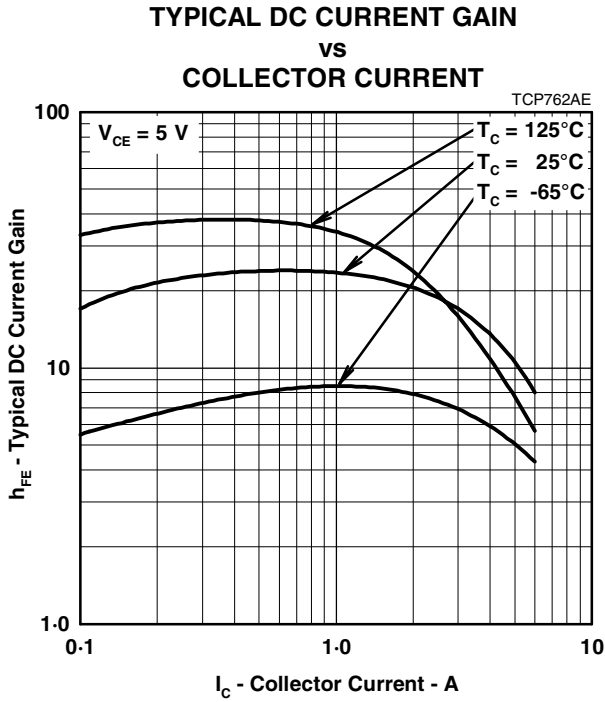

Figure 3.

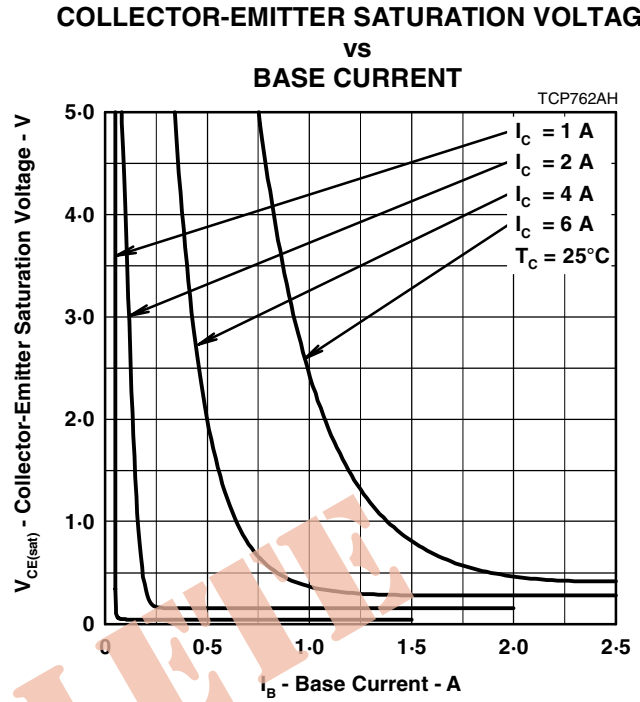

Figure 4.

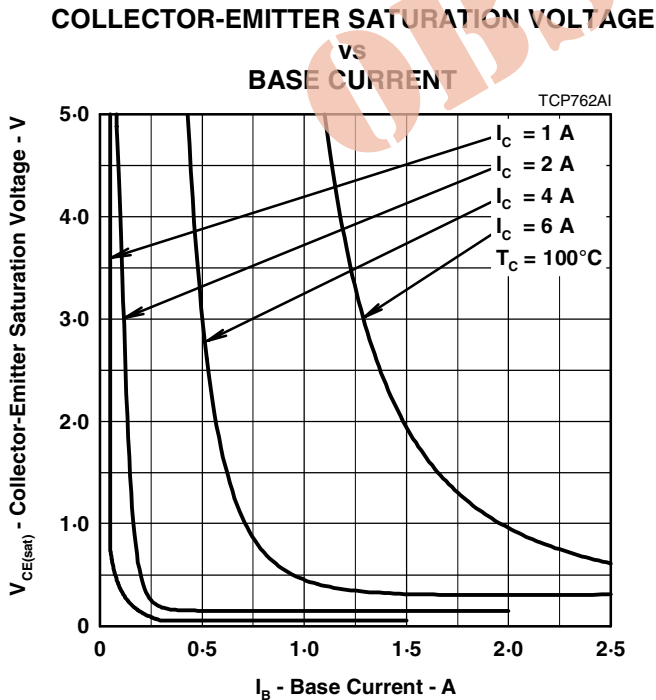

Figure 5.

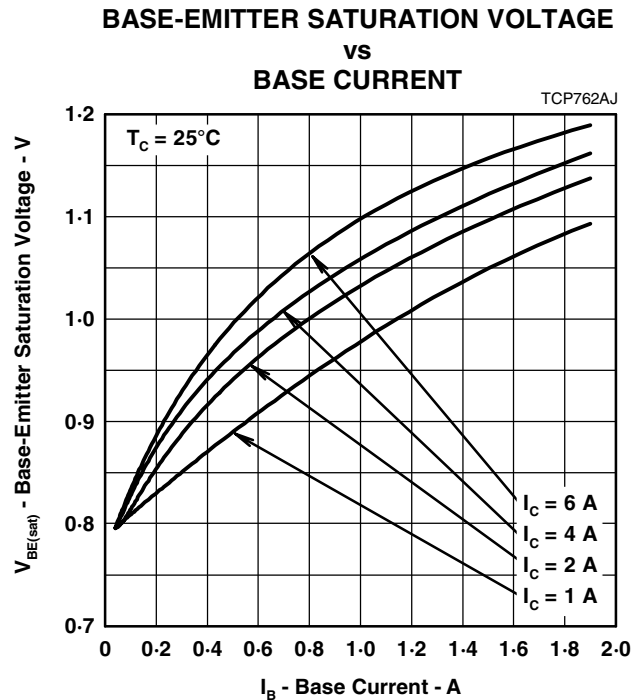

Figure 6.

**PRODUCT INFORMATION**

AUGUST 1978 - REVISED SEPTEMBER 2002  
Specifications are subject to change without notice.

**TYPICAL CHARACTERISTICS**

**COLLECTOR CUT-OFF CURRENT  
vs  
CASE TEMPERATURE**

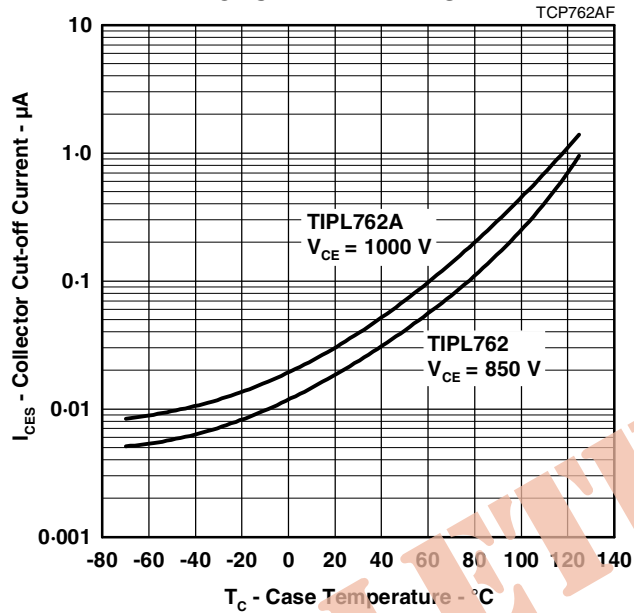

Figure 7.

**MAXIMUM SAFE OPERATING REGIONS**

**MAXIMUM FORWARD-BIAS  
SAFE OPERATING AREA**

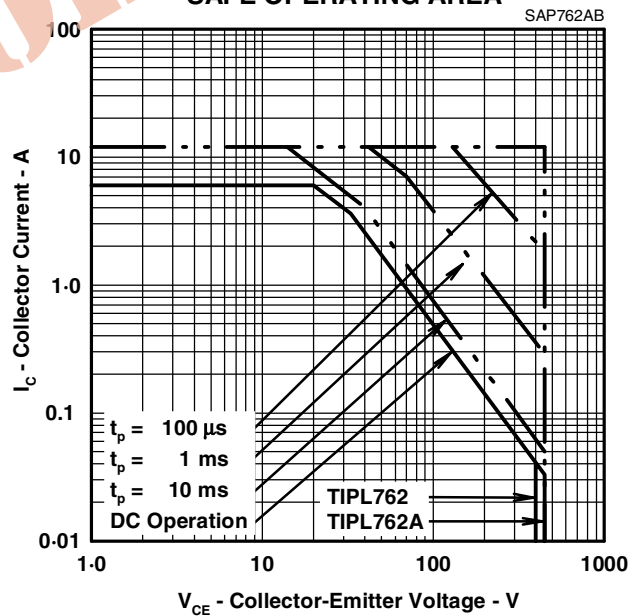

Figure 8.

**PRODUCT INFORMATION**

AUGUST 1978 - REVISED SEPTEMBER 2002  
Specifications are subject to change without notice.

**THERMAL INFORMATION**

**THERMAL RESPONSE JUNCTION TO CASE  
VS  
POWER PULSE DURATION**

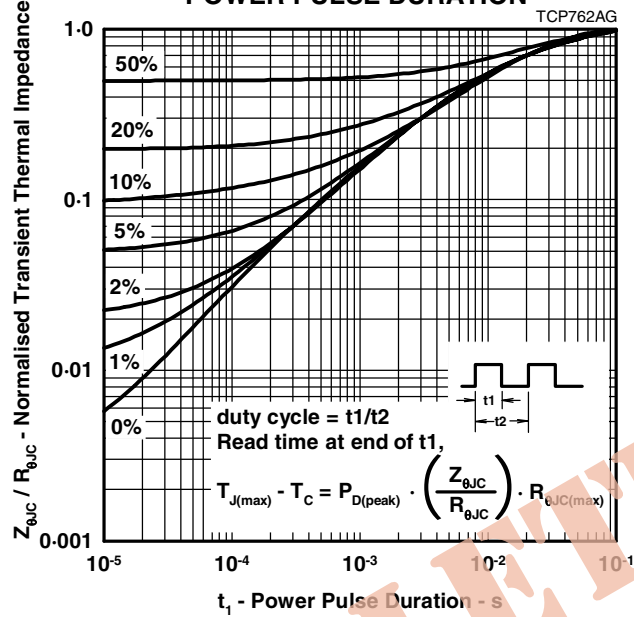

Figure 9.

OBSOLETE