



THE DATASHEET OF TIPL770-S



BOURNS®

- Rugged Triple-Diffused Planar Construction
- 2.5 A Continuous Collector Current
- Operating Characteristics Fully Guaranteed at 100°C
- 850 Volt Blocking Capability
- 50 W at 25°C Case Temperature

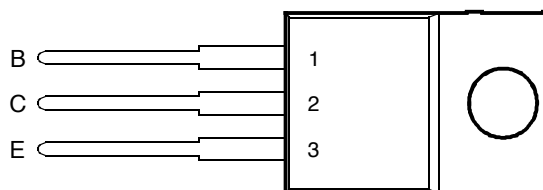
TO-220 PACKAGE
(TOP VIEW)

Pin 2 is in electrical contact with the mounting base.

MDTRACA



This series is obsolete and not recommended for new designs.

absolute maximum ratings at 25°C case temperature (unless otherwise noted)

RATING	SYMBOL	VALUE	UNIT
Collector-base voltage ($I_E = 0$)	V_{CBO}	850	V
Collector-emitter voltage ($V_{BE} = 0$)	V_{CES}	850	V
Collector-emitter voltage ($I_B = 0$)	V_{CEO}	400	V
Emitter-base voltage	V_{EBO}	10	V
Continuous collector current	I_C	2.5	A
Peak collector current (see Note 1)	I_{CM}	8	A
Continuous device dissipation at (or below) 25°C case temperature	P_{tot}	50	W
Operating junction temperature range	T_j	-65 to +150	°C
Storage temperature range	T_{stg}	-65 to +150	°C

NOTE 1: This value applies for $t_p \leq 10$ ms, duty cycle $\leq 2\%$.**PRODUCT INFORMATION**MARCH 1984 - REVISED SEPTEMBER 2002
Specifications are subject to change without notice.

electrical characteristics at 25°C case temperature (unless otherwise noted)

PARAMETER	TEST CONDITIONS	MIN	TYP	MAX	UNIT
$V_{CE(sus)}$ Collector-emitter sustaining voltage	$I_C = 100 \text{ mA}$ $L = 25 \text{ mH}$ (see Note 2)	400			V
I_{CES} Collector-emitter cut-off current	$V_{CE} = 850 \text{ V}$ $V_{BE} = 0$ $V_{CE} = 850 \text{ V}$ $V_{BE} = 0$ $T_C = 100^\circ\text{C}$			5 200	μA
I_{CEO} Collector cut-off current	$V_{CE} = 400 \text{ V}$ $I_B = 0$			5	μA
I_{EBO} Emitter cut-off current	$V_{EB} = 10 \text{ V}$ $I_C = 0$			1	mA
h_{FE} Forward current transfer ratio	$V_{CE} = 5 \text{ V}$ $I_C = 0.5 \text{ A}$ (see Notes 3 and 4)	20		60	
$V_{CE(sat)}$ Collector-emitter saturation voltage	$I_B = 0.2 \text{ A}$ $I_C = 1 \text{ A}$ (see Notes 3 and 4) $I_B = 0.5 \text{ A}$ $I_C = 2.5 \text{ A}$ $I_B = 0.5 \text{ A}$ $I_C = 2.5 \text{ A}$ $T_C = 100^\circ\text{C}$			1.0 2.5 5.0	V
$V_{BE(sat)}$ Base-emitter saturation voltage	$I_B = 0.2 \text{ A}$ $I_C = 1 \text{ A}$ (see Notes 3 and 4) $I_B = 0.5 \text{ A}$ $I_C = 2.5 \text{ A}$ $I_B = 0.5 \text{ A}$ $I_C = 2.5 \text{ A}$ $T_C = 100^\circ\text{C}$			1.0 1.2 1.3	V
f_t Current gain bandwidth product	$V_{CE} = 10 \text{ V}$ $I_C = 0.5 \text{ A}$ $f = 1 \text{ MHz}$		12		MHz
C_{ob} Output capacitance	$V_{CB} = 20 \text{ V}$ $I_E = 0$ $f = 0.1 \text{ MHz}$		55		pF

- NOTES: 2. Inductive loop switching measurement.
3. These parameters must be measured using pulse techniques, $t_p = 300 \mu\text{s}$, duty cycle $\leq 2\%$.
4. These parameters must be measured using voltage-sensing contacts, separate from the current carrying contacts.

thermal characteristics

PARAMETER	MIN	TYP	MAX	UNIT
$R_{\theta JC}$ Junction to case thermal resistance			2.5	$^\circ\text{C/W}$

inductive-load-switching characteristics at 25°C case temperature (unless otherwise noted)

PARAMETER	TEST CONDITIONS †	MIN	TYP	MAX	UNIT
t_{sv} Voltage storage time	$I_C = 2.5 \text{ A}$ $I_{B(on)} = 0.5 \text{ A}$ (see Figures 1 and 2) $V_{BE(off)} = -5 \text{ V}$			2	μs
t_{rv} Voltage rise time				200	ns
t_{fi} Current fall time				200	ns
t_{ti} Current tail time				50	ns
t_{xo} Cross over time				300	ns
t_{sv} Voltage storage time	$I_C = 2.5 \text{ A}$ $I_{B(on)} = 0.5 \text{ A}$ (see Figures 1 and 2) $V_{BE(off)} = -5 \text{ V}$ $T_C = 100^\circ\text{C}$			2.5	μs
t_{rv} Voltage rise time				400	ns
t_{fi} Current fall time				250	ns
t_{ti} Current tail time				50	ns
t_{xo} Cross over time				500	ns

† Voltage and current values shown are nominal; exact values vary slightly with transistor parameters.

PARAMETER MEASUREMENT INFORMATION

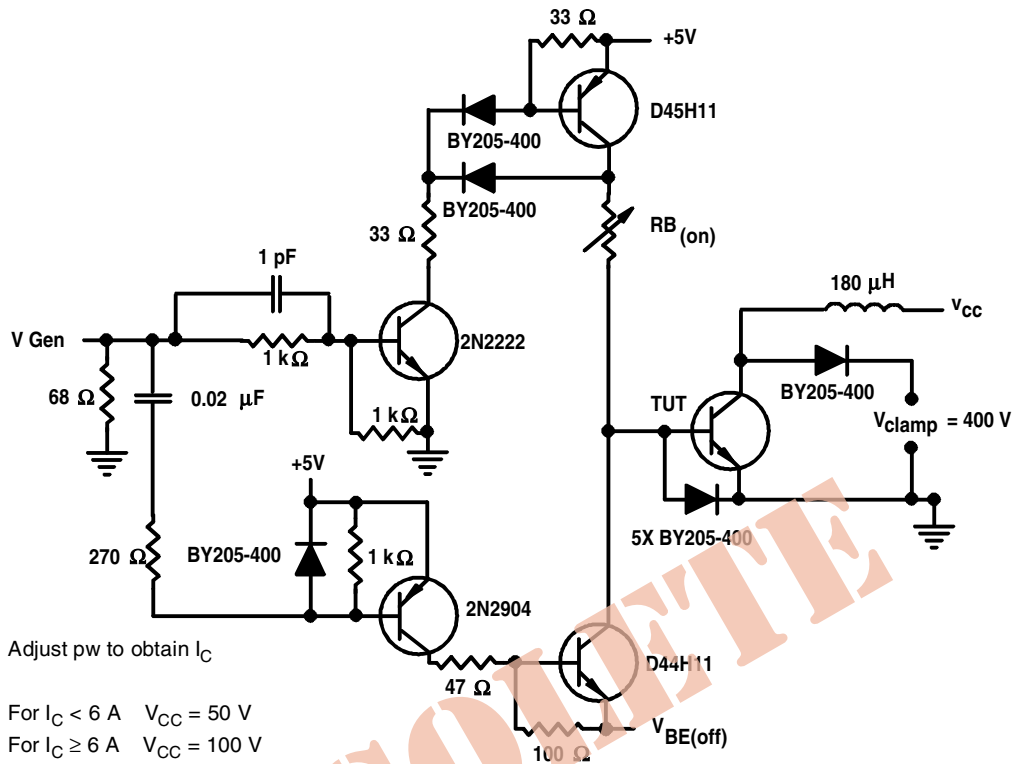
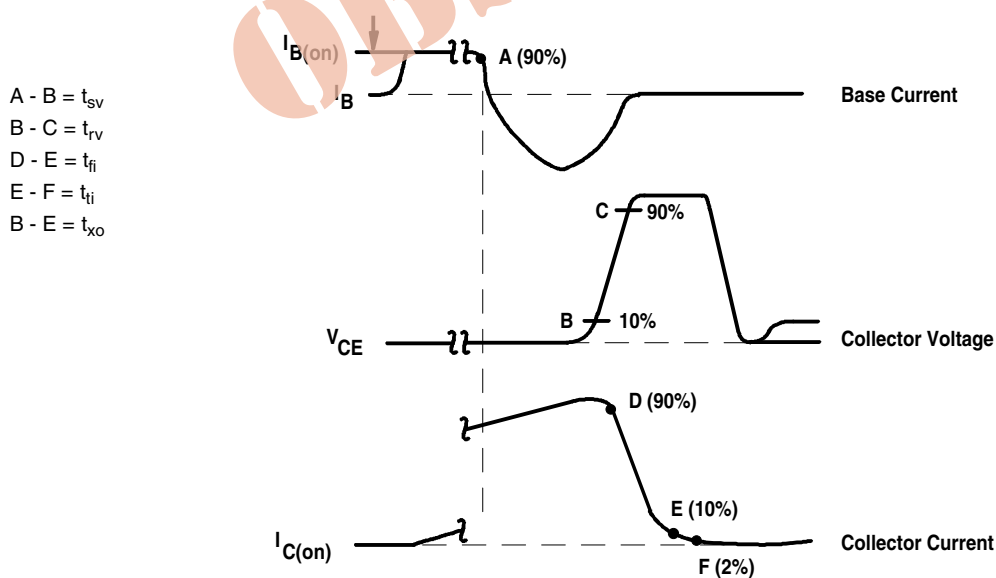

Figure 1. Inductive-Load Switching Test Circuit



NOTES: A. Waveforms are monitored on an oscilloscope with the following characteristics: $t_r < 15\text{ ns}$, $R_{in} > 10\ \Omega$, $C_{in} < 11.5\text{ pF}$.
 B. Resistors must be noninductive types.

Figure 2. Inductive-Load Switching Waveforms

PRODUCT INFORMATION

TYPICAL CHARACTERISTICS

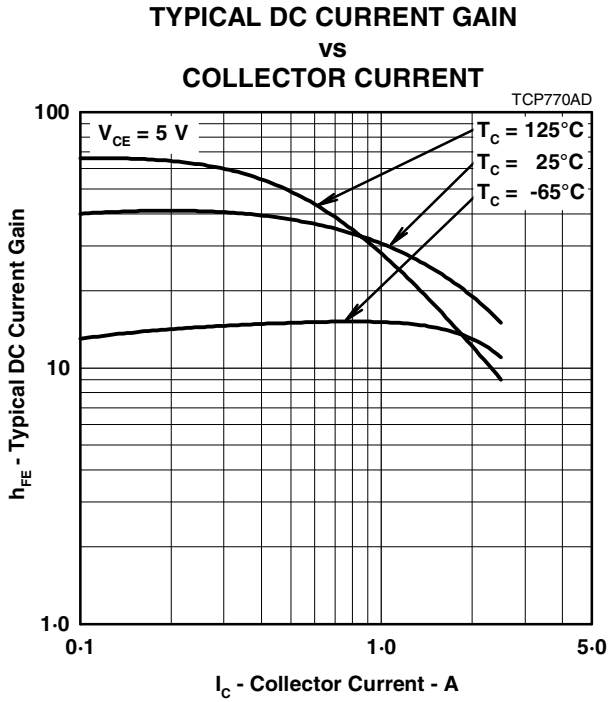

Figure 3.

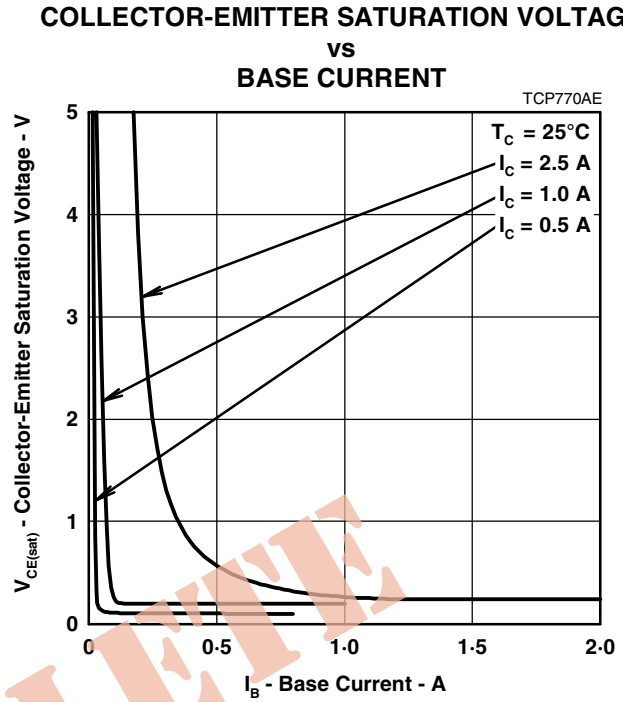

Figure 4.

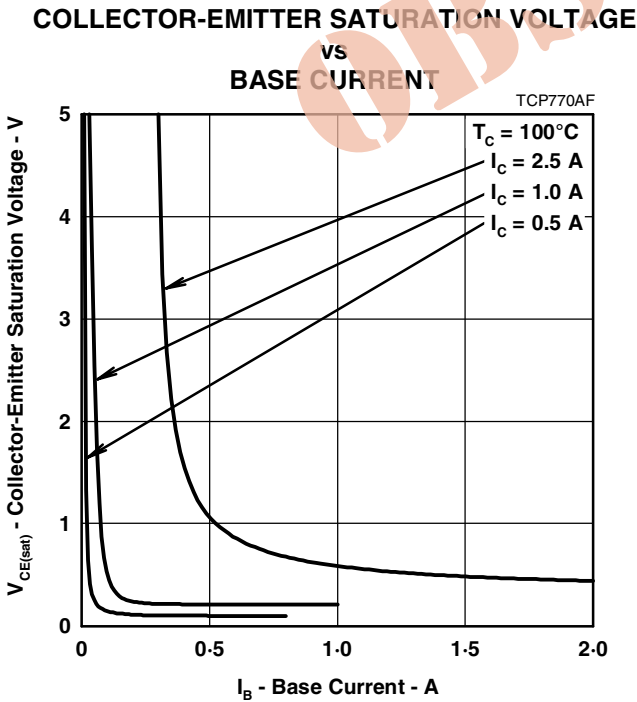

Figure 5.

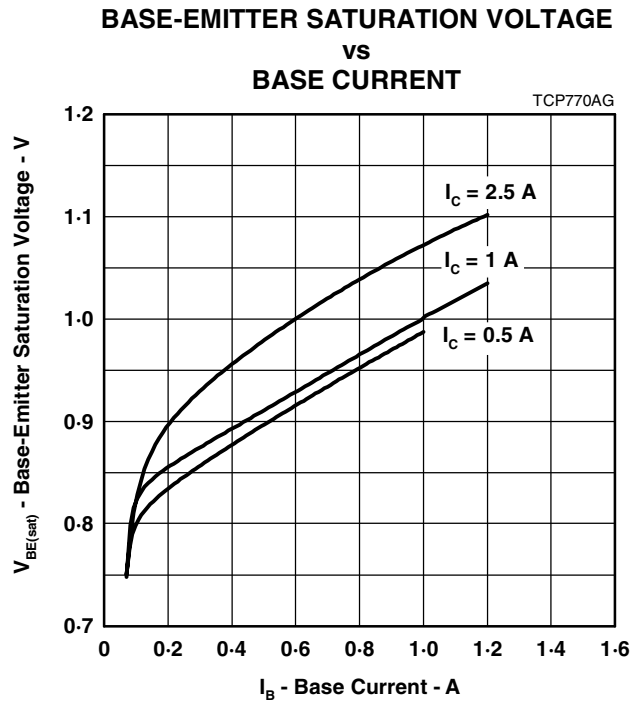
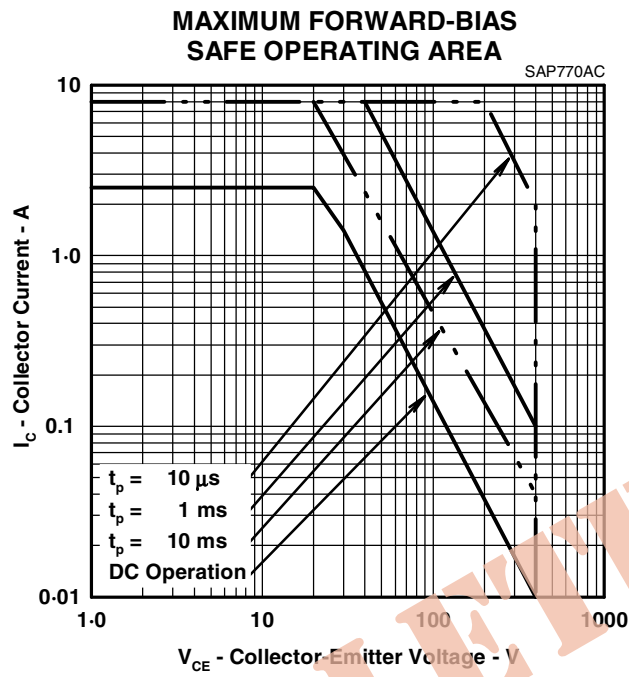

Figure 6.

PRODUCT INFORMATION

MARCH 1984 - REVISED SEPTEMBER 2002
Specifications are subject to change without notice.

MAXIMUM SAFE OPERATING REGIONS



PRODUCT INFORMATION

MARCH 1984 - REVISED SEPTEMBER 2002
Specifications are subject to change without notice.