



Jiangsu Everstar Electronics Co., Ltd.
Address: No.111 Tianmu Rd, Tianmuhu Town, Liyang City, Jiangsu Province, China
TEL: +86-519-87557772 FAX: +86-519-87557773
Http: www.everstarelect.com

DATA SHEET

ESL NO.. : ESS-JC210TGJRKT

CUSNO.. :

REV : A / 0

Producer:

Auditor:

Approver:

CUSTOMER'S APPROVAL : _____

DCC : _____



1.0×1.0×0.4mm SMD LED LED

ESS-JC210TGJRKT

REV:A0

PACKAGE DIMENSIONS

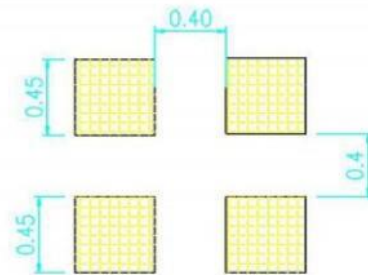
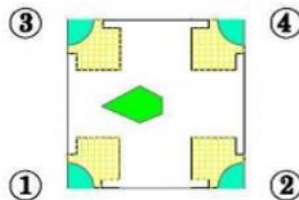
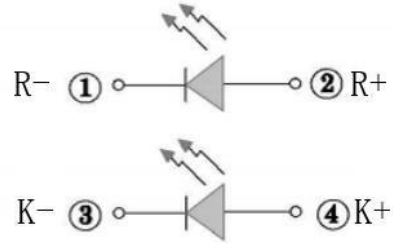
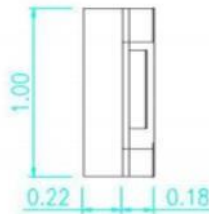
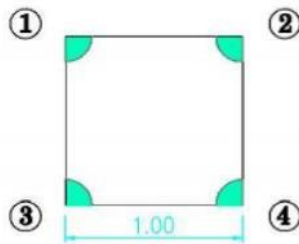
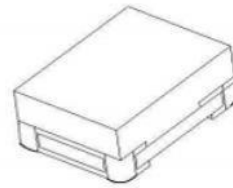
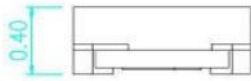

建议焊盘尺寸



1.0×1.0×0.4mm SMD LED LED

ESS-JC210TGJRKT

REV:A0

Feature:

- * High Luminous Intensity
- * Low Power Dissipation
- * good Reliability
- * Long Life

Applications:

- * household appliance
- * dashboard
- * communication equipmen

CHIP MATERIALS :

- * Dice Material: GaP/GaN
- * Lens Color: Water Clear
- * Light Color: Red/Green

ABSOLUTE MAXIMUM RATING : (Ta = 25°C)

Symbol	DESCRIPTION	Rated		Unit
		Red	Green	
Topr	Operating Temperature Range	-30°C ~ +85°C		
Tstg	Storage Temperature Range	-40°C ~ +100°C		
VR	Reverse Voltage Per Chip	5	5	V
PD	Power Dissipation Per Chip	60	80	mW
IF	Average Forward Current Per Chip	100	100	mA
IFp	Peak Forward Current Per Chip	20	20	mA

ELECTRO-OPTICAL CHARACTERISTICS : (Ta = 25°C)

Parameter	Symbol	Condition	Device	MIN.	TYP	MAX	UNIT
Reverse Current	IR	VR=5V				5	μA
Forward Voltage	VF	IF=5mA	Red	1.8	2.0	2.2	V
			G	2.8	3.0	3.2	
PeakWavelength	λ P		Red	620		625	nm
			G	515		525	
Spectrum Radiation Bandwidth	Δ λ					20	nm
Luminous Intensity	IV		Red	30		75	mcd
			G	200		300	
View Angle	2θ1/2			R/G		120	



1.0×1.0×0.4mm SMD LED LED

ESS-JC210TGJRKT

REV:A0

Typical Electro-Optical Characteristics Curves

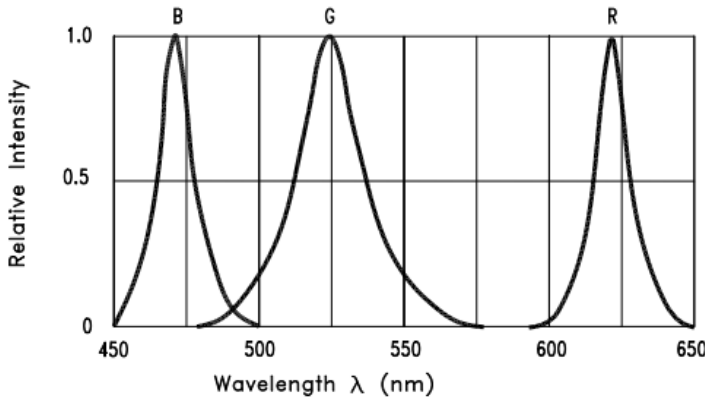

Fig.1 RELATIVE INTENSITY VS. WAVELENGTH

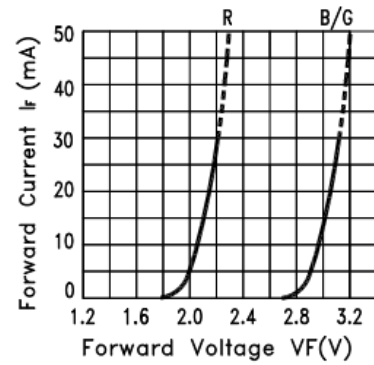

Fig.2 FORWARD CURRENT VS. FORWARD VOLTAGE

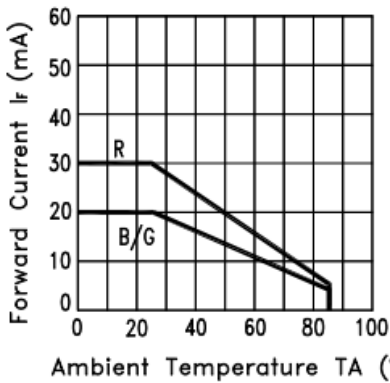

Fig.3 FORWARD CURRENT DERATING CURVE

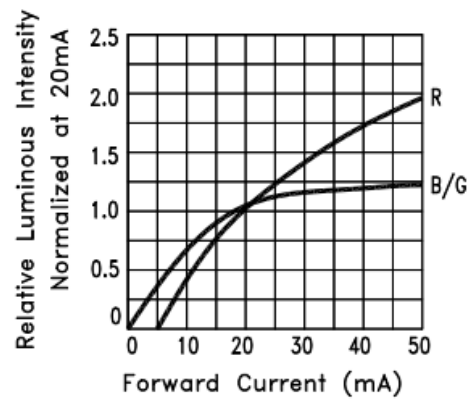

Fig.4 RELATIVE LUMINOUS INTENSITY VS. FORWARD CURRENT

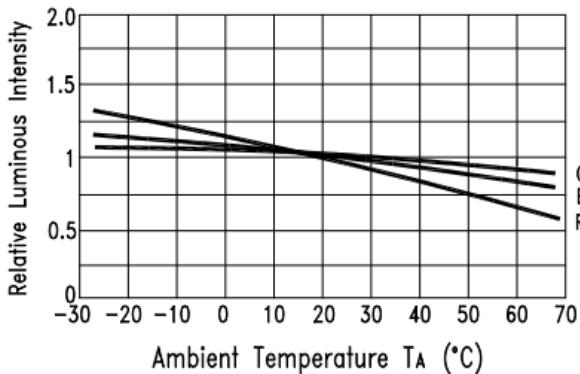

Fig.5 Luminous Intensity vs. Ambient Temperature

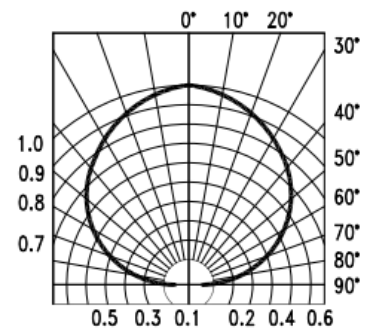

Fig.6 SPATIAL DISTRIBUTION



1.0×1.0×0.4mm SMD LED LED

ESS-JC210TGJRKT

REV:A0

Reel and Tape Dimensions:

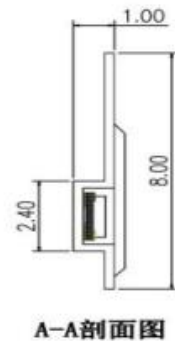
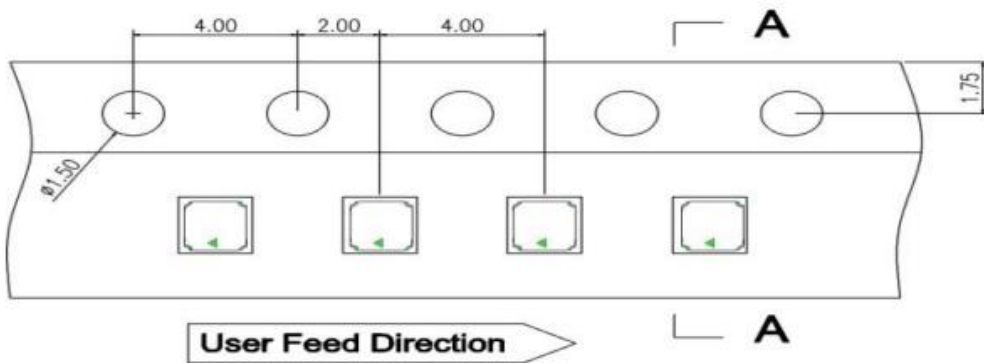
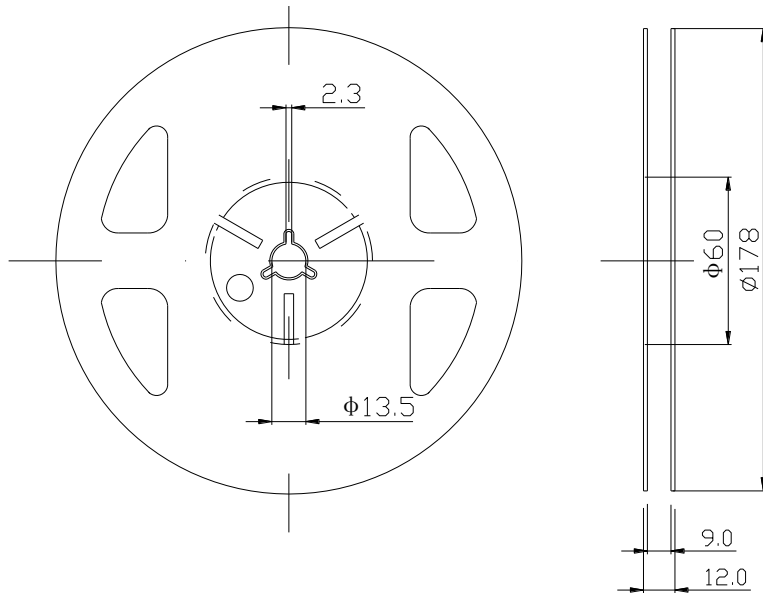

Note:

- 1. All Dimensions are in millimeters
- 2. Tolerance is ± 0.1 Unless otherwise specified



1.0×1.0×0.4mm SMD LED LED

ESS-JC210TGJRKT

REV:A0

Packaging:

Moisture Proof and Anti-Electrostatic Foil Bag

Cardboard Box



1.0×1.0×0.4mm SMD LED LED

ESS-JC210TGJRKT

REV:A0



1.0×1.0×0.4mm SMD LED LED

ESS-JC210TGJRKT

REV:A0



1.0×1.0×0.4mm SMD LED LED

ESS-JC210TGJRKT

REV:A0

Reliability Test:

test item	Test Conditions	Quantity	Judging Criteria
Solderability	(Solder Temperature) : 300°C (Solder Duration) : (3.5±0.5) sec.	15	Solderable Area Over 95%
Thermal Shock Followed by High Temperature And High Humidity Cyclic		11	C=0 & I*
Resistance For Soldering Heat	ReflowSoldering	15	C=0 & I*
DC Operating Life	1000hrs AForward Current;25m	22	C=0 & I*
High Temperature Storage	100°C41000hrs.	15	C=0 & I*
High Temperature And High Humidity Cyclic	25°C~55°C (90%~95%) RH 6 Cycles for 144 hrs.Recover for 2 hrs.	11	C=0 & I*

ItemS	Symbol	Test Conditions	Criteria For Judging Damage I	Criteria For Judging Damage I
Forward Voltage	F	IF=20m	A≥USL×1.2	≥USL
Reverse Current	IR	VR=5V	≥USL×2.0≥USL	≥USL
Luminous Intensity	IV	IF=20mA	≤LSL×0.5	≤LSL